

Manual on field recording techniques and protocols for All Taxa Biodiversity Inventories and Monitoring

Edited by:

J. Eymann, J. Degreeef, Ch. Häuser,
J.C. Monje, Y. Samyn and D. VandenSpiegel



Volume 8, part 1 (2010)



the Series of Manuals
Dedicated to Capacity Building
in Taxonomy and
Collection Management

WITH THE SUPPORT OF
THE BELGIAN
DEVELOPMENT COOPERATION 

Editors

Yves Samyn - Zoology (non African)

Belgian Focal Point to the Global Taxonomy Initiative
Royal Belgian Institute of Natural Sciences
Rue Vautier 29, B-1000 Brussels, Belgium
yves.samyn@naturalsciences.be

Didier VandenSpiegel - Zoology (African)

Department of African Zoology
Royal Museum for Central Africa
Chaussée de Louvain 13, B-3080 Tervuren, Belgium
dvdsiegel@africamuseum.be

Jérôme Degreef - Botany

Belgian Focal Point for the Global Strategy for Plant Conservation
National Botanic Garden of Belgium
Domaine de Bouchout, B-1860 Meise, Belgium
jerome.degreef@br.fgov.be

Instructions to authors

<http://www.abctaxa.be>

ISSN 1784-1283 (hard copy)
ISSN 1784-1291 (on-line pdf)
D/2010/0339/3

Manual on field recording techniques and protocols for All Taxa Biodiversity Inventories (ATBIs), part 1

Edited by

Jutta Eymann

Staatliches Museum für Naturkunde Stuttgart
Rosenstein 1, 70191 Stuttgart, Germany
Email: eymann.smns@naturkundemuseum-bw.de

Jérôme Degreef

National Botanic Garden of Belgium
Domaine de Bouchout, B-1860 Meise, Belgium
Email: jerome.degreef@br.fgov.be

Christoph L. Häuser

Museum für Naturkunde
Invalidenstr. 43, 10115 Berlin, Germany
Email: Christoph.Haeuser@mfn-berlin.de

Juan Carlos Monje

Staatliches Museum für Naturkunde Stuttgart
Rosenstein 1, 70191 Stuttgart, Germany
Email: monje.smns@naturkundemuseum-bw.de

Yves Samyn

Royal Belgian Institute of Natural Sciences
Vautierstraat 29, B-1000 Brussels, Belgium
Email: yves.samyn@naturalsciences.be

Didier VandenSpiegel

Royal Museum for Central Africa
Chaussée de Louvain 13, B-3080 Tervuren, Belgium
Email: dvdspiegel@africamuseum.be

Cover illustration: *Arachnoscelis* sp. [Orthoptera Tettigoniidae, predator] found in San Lorenzo forest, during the large-scale biotic inventory IBISCA-Panama (Photo by Maurice Leponce).

Table of contents, part 1

Chapter 1 - Background and aim of this manual

Ch. Häuser, J. Degreef, X. Eekhout, J. Eymann, J.C. Monje, K. Riede, D. VandenSpiegel, J. Van Goethem and Y. Samyn

Chapter 2 - The European Distributed Institute for Taxonomy (EDIT) and the "all taxa biodiversity inventory & monitoring" (ATBI+M) approach

Ch. Häuser, S. Tillier, C. Monje, J. Eymann, A. Hoffmann, A. Kroupa and G. Lancelot

Chapter 3 - Challenges and solutions for planning and implementing large-scale biotic inventories

M. Leponce, Ch. Meyer, Ch. Häuser, Ph. Bouchet, J. Delabie, L. Weigt, and Y. Basset

Chapter 4 - Individual records and the associated data: information standards and protocols

A. Kroupa and D. Remsen

Chapter 5 - Bioacoustics approaches in biodiversity inventories

M.K. Obrist, G. Pavan, J. Sueur, K. Riede, D. Llusia and R. Márquez

Chapter 6 - Camera-trapping for inventorying terrestrial vertebrates

F. Rovero, M. Tobler, and J. Sanderson

Chapter 7 - Organizing specimen and tissue preservation techniques in the field for subsequent molecular analyses

B. Gemeinholzer, I. Rey, K. Weising, M. Grundmann, A.N. Müllner, H. Zetsche, G. Droege, O. Seberg, G. Petersen, D.M. Rawson and L.A. Weigt

Chapter 8 - Sampling arthropods from the canopy by insecticidal knock-down

A. Floren

Chapter 9 - Soil and litter sampling, including MSS

M. Alonso-Zarazaga and Teresa Domingo

Chapter 10 - Sampling continental freshwater

A. Garcia-Valdecasas, M. Aboal, S. Cirujano, S. Iepure, D. Jaume, H. Proctor and J. Luis Velasco

Chapter 11 - Sampling the Marine Realm

J. Templado, G. Paulay, A. Gittenberger and Ch. Meyer

Chapter 12 - Collecting the forgotten kingdom: Guidelines for the field mycologist with emphasis on the larger fungi

B. Buyck, Th. Læssøe, M. Meyer and V. Hofstetter

Chapter 1

Background and aim of this manual

by

Christoph L. Häuser

Museum für Naturkunde
Invalidenstr. 43, 10115 Berlin, Germany
Email: christoph.haeuser@mfn-berlin.de

Jérôme Degreef

National Botanic Garden of Belgium
Domaine de Bouchout, B-1860 Meise, Belgium
Email: jerome.degreef@br.fgov.be

Xavier Eekhout

Department of Biodiversity and Evolutionary Biology
National Museum of Natural History (CSIC)
Jose Gutierrez Abascal 2, 28006 Madrid, Spain.
Email: xeekhout@mncn.csic.es

Jutta Eymann &

Juan Carlos Monje

Staatliches Museum für Naturkunde Stuttgart
Rosenstein 1, 70191 Stuttgart, Germany
Email: jutta.eymann@gmx.de, monje.smns@naturkundemuseum-bw.de

Klaus Riede

Zoologisches Museum und Forschungsinstitut Alexander Koenig
Adenauerallee 160, 53113 Bonn, Germany
Email: k.riede.zfmk@uni-bonn.de

Didier VandenSpiegel

Royal Museum for Central Africa
Chaussée de Louvain 13, B-3080 Tervuren, Belgium
Email: dvdspiegel@africamuseum.be

Jackie Van Goethem &

Yves Samyn

Royal Belgian Institute of Natural Sciences
Vautierstraat 29, B-1000 Brussels, Belgium
Email: jackie.vangoethem@naturalsciences.be, yves.samyn@naturalsciences.be

1. Introduction

The idea for this book originated when planning, organizing and carrying out field work for the first All Taxa Biodiversity Inventory and Monitoring (ATBI+M) pilot sites established in the National Parks Mercantour and Alpi Marittime (France/Italy) in 2007, as part of the activities of the EDIT (European Distributed Institute of Taxonomy: www.e-taxonomy.eu) network, supported for five years by the European Commission. One of the overall aims of the EDIT project is to better integrate taxonomic research with biodiversity conservation. To attain this objective, innovative and new methods and tools for inventorying and monitoring biodiversity have to be deployed (Häuser *et al.*, 2007).

Individual participants embarking on inventories as well as partners from the hosting national parks frequently asked the project coordinators which are the best-recommended or "standard" techniques and protocols for inventorying specific taxa or habitats. Formulating a response to these questions often was not straightforward as several approaches and methods are described in the, often scattered, literature. In order to provide ATBI+M participants, as well as other interested parties, with appropriate information, it was proposed that "field experiences" should be captured and made available for wider dissemination and use.

2. Background and aim

The intention to produce an explicative manual that liberates 'good practices' in ATBI+M methods was agreed on during a workshop on "ATBI+M field recording techniques and protocols" which was organized from 12-17 June 2007 at the El Ventorillo Field Station of the Museo Nacional de Ciencias Naturales, north of Madrid, Spain (Eekhout & Riede, 2007). This meeting brought together participants for practical demonstrations and hand on tests of various field methods, tools and equipment, ranging from light trapping over bioacoustics to tissue sampling techniques.

During a second EDIT workshop - convened from 25-27 January 2009 at the Botanic Gardens Canario 'Viera y Clavijo' at Las Palmas de Gran Canaria, Spain - several potential authors and contributors for the ATBI+M manual were brought together (Eymann & Monje, 2009). This meeting, attended by 34 participants from 12 EDIT partner institutions in Europe and the United States (fig. 1), had as net result the outline for this book detailing individual parts and chapters, most of which now constitute the core of the present volume. It was also agreed that the manual should really focus on the practical aspects of fieldwork, particularly collecting and recording techniques, as well as on questions related to subsequent treatment of collected materials and data analysis.

From the EDIT perspective, the main target audience would include students and researchers participating at ATBI+M and other biodiversity inventory or monitoring projects, who already have a good background in biodiversity research or even specialist knowledge for a certain group, but who want to embark on surveying groups and habitats not yet familiar to them.

While EDIT's reach from its funding and network perspective being mostly European, all prospective authors agreed that the geographic focus of such a book should be global, and not restricted to (European) temperate habitats and conditions. Also all contributors agreed that this manual should not just be produced in print, but should also be freely available online, with the aim of regular updating. The latter desire originates with the realisation that the formulated recommendations on (digital) equipment will most possibly be swiftly outdated given the current rapid pace of innovation.

3. *Abc Taxa* as the artery that spreads capacity in taxonomy and collection management

To assure high quality, open access and wide dissemination, both in Europe and beyond, the journal *Abc Taxa* (www.abctaxa.be) was chosen as publication medium.

Abc Taxa is the capacity building journal of the Belgian National Focal Point to the Global Taxonomy Initiative (Samyn *et al.*, 2008). This relatively new journal started in 2006 and has in the past been entirely funded by the Belgian Development Cooperation (www.dgdc.be) who recognizes that worldwide critical taxonomic capacity is needed to underpin effective sustainable exploitation and conservation of biodiversity, in particular in developing countries where man directly relies on the goods and services that biodiversity supplies.

For the production and distribution of the present volume, an equal-cost sharing partnership between the Belgian GTI National Focal Point and EDIT was set up. The Belgian GTI office will, conform to its usual strategy, distribute the book through the GTI and CHM (Clearing-House Mechanism) network of the Convention on Biological Diversity and, on motivated demand, send it free of charge to interested parties in developing countries. EDIT WP7, on the other hand, will distribute the book to participants of ATBI+M projects and to selected parties in the EDIT network.

For the research community outside the EDIT network and the developing world copies can be purchased with *Abc Taxa* at making and distribution cost. Prices are indicated on the site of the series (www.abctaxa.be).

4. Conclusion

While hopefully offering a comprehensive and relevant source of information for conducting fieldwork, this manual is not meant to establish individual methods or specific approaches as new or universal standards. Rather, as expressed in several contributions, the exact approach or precise standard to be followed for any particular study should be determined by the specific question(s) being asked, also by taking the available budget and resources into account.

In presenting the relevant techniques, their advantageous and disadvantageous aspects and the efforts required, this book strives to be a useful basis to select the "best" method under individual circumstances. Obviously, not all major taxa, habitats or methods have been covered in this volume, but we expect that the

present volume of the series *Abc Taxa* will be welcomed as a useful and comprehensive compendium of best practises in ATBI+M and other fieldwork.



Fig. 1. Participants to the 'ATBI+M Manual' workshop in Las Palmas (Photo by A. Steiner).

5. References

HÄUSER, C.L., RIEDE, K. & BOS, M. 2007. Second Workshop on ATBI+M: Data recording methods and extra-European site selection. *EDIT Newsletter 2*: 9-10.

EEKHOUT, X. & RIEDE, K. 2007. Workshop on ATBI+M field recording techniques and protocols. *EDIT Newsletter 3*: 6.

EYMANN, J. & MONJE, J.C. 2009. Workshop: Manual on field techniques and protocols for ATBI+M. *EDIT Newsletter 14*: 9-10.

SAMYN, Y., VANDENSPIEGEL, D., DEGREEF, J. & VAN GOETHEM, J. 2008. *Abc Taxa*, a new series of manuals dedicated to capacity building in taxonomy and collection management. *EDIT Newsletter 7*: 11.

Chapter 2

The European Distributed Institute for Taxonomy (EDIT) and the "all taxa biodiversity inventory & monitoring" (ATBI+M) approach

by

Christoph L. Häuser

Museum für Naturkunde
Invalidenstr. 43, 10115 Berlin, Germany
Email: christoph.haeuser@mfn-berlin.de

Simon Tillier

Muséum National d'Histoire Naturelle,
EDIT, CP43, 57 rue Cuvier, 75231 Paris cedex 05, France
Email: edit@mnhn.fr

Carlos Monje

Staatliches Museum für Naturkunde Stuttgart
Rosenstein 1, 70191 Stuttgart, Germany
Email: monje.smns@naturkundemuseum-bw.de

Jutta Eymann

Staatliches Museum für Naturkunde Stuttgart
Rosenstein 1, 70191 Stuttgart, Germany
Email: eymann.smns@naturkundemuseum-bw.de

Anke Hoffmann

Museum für Naturkunde
Invalidenstr. 43, 10115 Berlin, Germany
Email: anke.hoffmann@mfn-berlin.de

Alexander Kroupa

Museum für Naturkunde
Invalidenstr. 43, 10115 Berlin, Germany
Email: alexander.kroupa@mfn-berlin.de

Gael Lancelot

Muséum National d'Histoire Naturelle
EDIT, CP43, 57 rue Cuvier, 75231 Paris cedex 05, France
Email: edit@mnhn.fr

1. The European Distributed Institute of Taxonomy (EDIT)

While providing the overall framework for integrating the available knowledge on the Worlds' organisms and thereby linking all biological sciences, taxonomy has been and continues to be not a quickly delivering discipline of research. Rapid progress in taxonomy and systematic is still hampered by a huge degree of fragmentation both in effort, and its deliverables and products. While looking back over more than 250 years of continuing scholarly efforts to catalogue the Worlds organisms, still today there is no single global inventory or directory of just all known species available, and most countries and regions lack current up-to-date inventories for large parts of their biota (Soberón & Peterson, 2009). The general challenge facing taxonomy is integrating and making available a vast amount of information scattered across 250 years of literature, in countless biological collections all over the world, on a growing number of websites, and in the minds of taxonomists belonging to hundreds of institutions worldwide. Even today new species descriptions (ca 20,000 each year) are being published scattered across many hundreds of specialist journals and monographs, without even a globally universal index available (Polaszek, 2005). This hampers efficient work even for taxonomists and makes it harder for researchers to increase society's understanding of biodiversity and ecosystems functioning. The increasing need for overcoming this information bottleneck and transforming taxonomy towards a more integrative, modern information science have long been recognized and expressed by scholars within and outside taxonomy (e.g., Godfrey, 2002; Mallet & Willmott, 2003; Scoble, 2004; Wheeler & Valdecasas, 2005; Mayo *et al.*, 2008; La Salle *et al.*, 2009; Schlick-Steiner *et al.*, 2010).

As taxonomy also provides elementary baseline data and an operational framework for biodiversity conservation, biological control, forest management, and many other applied fields (Rosen, 1986; New 1996; McNeely, 2002), this has direct and often far reaching consequences for efforts to reduce biodiversity loss and provide more environmental sustainability. Conservationists, ecologists, and other stakeholders of biodiversity need not only taxonomic checklists and revisions, but also integrated, user-friendly access to species names, as well as the means to identify them, their distribution, and their general biology (Golding & Timberlake, 2003). At present, such access is poor. The challenge for the taxonomic community is to find ways of increasing data quality and providing wider access to information through integration of effort and data sources.

With support from the European Commission under its 6th Framework Programme (FP6), the European Distributed Institute of Taxonomy (EDIT: www.e-taxonomy.eu) aims at addressing these problems of information access and management of knowledge in a rapidly changing environment. EDIT is the collective answer of a consortium of 29 leading European, North American and Russian taxonomic institutions to a dedicated call of the European Commission, issued in 2004, for a network in "Taxonomy for Biodiversity and Ecosystem Research" (Tillier *et al.*, 2005). The EDIT network started in 2006 with funding for five years, under the following operational and structural objectives:

- [1] To reduce fragmentation and to transform taxonomy into an integrated science
- [2] To strengthen the scientific, technological and information capacities needed for Europe to understand how biodiversity is modified through Global change
- [3] To progress toward a transnational entity by encouraging durable integration of the most important European taxonomic institutions, forming the nucleus of excellence around and from which institutions and taxonomists can integrate their activities
- [4] To promote the undertaking of collaborative research developing, improving and utilising the bio-informatics tools and technologies needed
- [5] To create a forum for stakeholders and end-users for taxonomy in biodiversity and ecosystem research
- [6] To promote the spreading of excellence to fulfil the needs of biodiversity and ecosystem research for taxonomy based information.

EDIT aims at building a virtual centre of excellence in taxonomy, facilitating interaction and access for providers – the researchers in taxonomy, inside and outside the consortium – as well as for users – researchers in biodiversity and ecosystems, but also all stakeholders involved in biodiversity conservation. The means and activities to progress toward these objectives are structured in seven interacting work packages (WPs) defined by specific integrative objectives (Fig. 1):

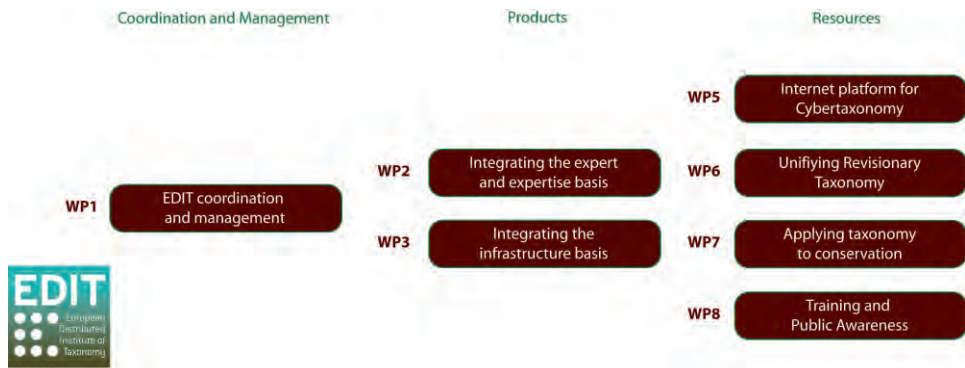

Fig. 1. The organizational structure of EDIT.

The scientific management and coordination of joint activities is conducted by the Network Office (WP1) and the Network Steering Committee (NSC), coordinated by the Project Leader according to advice provided by the Scientific Advisory Council (SAC), and strategic decisions taken by the Board of Directors (BoD). The organizational structure of EDIT is designed not only to facilitate effective monitoring and reporting of progress, but also to allow the network to develop and flourish over the 5 years of integration, thereby enabling the EDIT network to become the basis of lasting collaboration. The structure allows flexibility for

institutional members and also promotes shared responsibility for the network's sustainability as well as encouraging both formal and informal channels of communication.

EDIT specifically aims to strengthen the input of taxonomic expertise for biodiversity conservation. Therefore it organizes and supports the participation of taxonomists and other experts in biodiversity inventory and monitoring efforts in protected areas through its Workpackage 7, "Taxonomy for Conservation". The mechanism for achieving this objective is the establishment of "All Taxa Biodiversity Inventories + Monitoring" (ATBI+M) sites for selected protected areas and other areas of specific conservation concern.

2. All Taxa Biodiversity Inventories + Monitoring: The ATBI+M approach

The increasing need of sound taxonomic information and expertise for the successful implementation of biodiversity policies and, especially, conservation management programmes has been expressed widely at European and international fora. With the prevailing political focus on the establishment of an effective global network of protected areas for biodiversity conservation, efforts supporting an efficient inventorying and monitoring of biodiversity in existing and proposed protected areas seem particularly pertinent.

The current state of baseline inventory data and sound monitoring systems for most protected areas, however, is still highly inadequate. Even for generally well-studied and documented taxa like mammals, birds, vascular plants or groups of special conservation concern, such as species included in red lists or targeted in the European Natura 2000 initiative, existing inventories are not always regularly updated. Often, comparable data sets over larger time intervals documenting changes of the respective species and populations are not available or incomplete, due to the absence of monitoring programmes (Henry et al. 2008). Furthermore, most areas still lack basic inventory data usually for many groups, often comprising the largest parts of biodiversity (e.g., insects, fungi, micro-organisms), both in terms of species numbers, biomass, and ecological impact. Sound baseline inventory and monitoring data can provide the most reliable indicators for assessing effects of global environmental change on biodiversity. In more general terms, sound biodiversity inventories based on reliable species identification present elementary pre-requisites for implementing any taxon-specific conservation policy or management, such as the Natura 2000 directive.

2.1. What are ATBI+Ms?

ATBIs are intensive, large-scale efforts to record, identify, and document the entire biodiversity of a given area. EDIT's ATBI+M sites are different from traditional approaches in their longer-term orientation: from an initial species inventory, they will form the basis for future monitoring biodiversity changes over time in an era of global change. Furthermore, all species inventories are based not on mere presence-absence statements, but have to build on geo- and time-referenced primary occurrence data, i.e., actual records of individual organisms at a specific place and time, which can easily be tied to soil, climate, and other

abiotic information. It is important to understand that the goals of an ATBI+M include compiling species lists, but that such lists by themselves are of little direct conservation value. An ATBI+M collects information on habitat, distribution, time and date of occurrence for the species observed, abundance, and where possible, life history information. All groups are included and eventually targeted for research, but no one is under the illusion that every single species will be found, at least not over a shorter time span.

2.2. How did ATBIs arise?

The rationale leading to the concept of ATBI is expressed by White & Langdon (2006) as follows: “There is a fundamental flaw in how most parks and other natural reserves have been managed. In general, we have ignored a basic principle that would be fatal in the competitive world of business: we have never attempted a comprehensive inventory of our resources. This is surprising since the clearly stated purpose of most governmental and non-governmental conservation organizations has always been to protect and preserve the natural and cultural resources entrusted to their stewardship. How can we be intelligent stewards if we do not even know what kinds of resources we have, where they are found, their rarity, or, in the case of natural resources, some inkling of their ecological role?”

Dan Janzen, a renowned US ecologist, first conceived the idea and coined the expression of an All Taxa Biodiversity Inventory (ATBI) while conducting research in Costa Rica. Janzen’s concern about the rapid loss of tropical biodiversity prompted him to convene an international workshop to develop an approach for completing comprehensive inventories in a short amount of time (Janzen & Hallwachs, 1994). However, an initial attempt for an ATBI in the Area de Conservación Guanacaste in northwestern Costa Rica was terminated in 1996, when the organization responsible for receiving international funding and donations re-directed funds to other scientific endeavours.

In the fall of 1997 a call was issued to interested scientists and other partners to attend a rapidly convened, multi-day conference on the possibility of establishing an ATBI at the Great Smoky Mountains National Park (USA). Conference participants including Dan Janzen and Winnie Hallwachs who attended as advisors agreed that a second attempt for an ATBI was imperative, and that the Smokies was a good venue for such an attempt. As this project was too large for any one park, university, or museum to plan and manage, a new private, non-profit organization, Discover Life in America (DLIA), was created and eventually incorporated. There were to be three major thrusts or beneficiaries of the project: stewardship, science, and education. Following its establishment the project has seen increased participation, and 6,339 species new to the park have been recorded and 890 new species have been described (Sharkey, 2001; White & Langdon, 2006).

2.3. How are EDIT ATBI+M pilot sites initiated and how to participate?

Initially two EDIT workshops were held in 2006 and 2007 at the State Museum of Natural History in Stuttgart for interested partners, where 22 European and 11 non-European protected areas were proposed as potential ATBI+M pilot sites (see www.atbi.eu/forum/?q=node/682). All proposals were evaluated by participants and EDIT partners according to their scientific (taxonomic) interest, accessibility and logistics, local interest and support, as well as the state of knowledge and available data (Häuser *et al.* 2007). Following a ranking and further considerations of budget and feasibility, negotiations towards signing a Memorandum of Understanding (MoU) with the relevant authorities and counterpart institutions were conducted for selected sites, which specified conditions under which inventory and monitoring field work would be carried out, including possibilities of collecting biological specimens and obligations of data-sharing between EDIT's ATBI+M participants and the other partners. In generic terms, the EDIT ATBI+M approach provides individual taxonomists and other experts with opportunities to conduct their research under specific conditions at the pilot sites while agreeing to deliver and share all primary occurrence data and records with the relevant authorities and the project. As an additional incentive for participation, EDIT also provides limited support for travel and accommodation, as well as for logistics and equipment also encouraging the use of new recording tools and techniques. While participants can use the data and materials generated for their own research, they are obliged to provide the primary observation and collection data in a defined digital format, which allows for easy integration of records from many individual participants (Häuser *et al.* 2009).

Potential participants can register their interest at a dedicated website, a so-called "ATBI+M forum", where they can indicate their expertise, specific research interests and preferences, and also download relevant information guidelines and documents (www.atbi.eu/?q=node/1026). To initiate their participation all individual participants have to sign and submit detailed Terms of Reference which specify responsibilities and obligations, both for the participant, the EDIT project, and relevant authorities and counterparts. Arrangements for field work are made directly with project managers at the pilot site, whereas financial aspects are handled by the EDIT WP7 project management. EDIT's funding-schemes for supporting participants is adapted to each ATBI+M pilot site. Basically, transportation costs, accommodation and daily allowances are granted up to a fix amount for individual visits up to 2 weeks. All participants need to familiarize themselves with the data guidelines before embarking on any field work (see Chapter 4, for details). Reimbursement of costs claimed by participants occurs only in return for data delivered.

Filled-in tables of the localities visited and the collecting events from each field trip or session, at least, need to be submitted when asking for reimbursement, for which 70% of the costs claimed can be reimbursed directly following the fieldwork. Full reimbursement or reimbursement of the remaining 30% of costs will only occur after submitting the complete inventory/monitoring data.

All data delivered by participants have to undergo a data checking and cleaning procedure during which a close contact between the EDIT WP7 management and the individual scientist is maintained, which generally results in improved datasets which are subsequently uploaded to dedicated websites for individual ATBI+M pilot sites. The data generated from EDIT ATBI+M pilot sites are also made accessible through the Global Biodiversity Information Facility (GBIF: <http://data.gbif.org>), which also offers a means of immediate publication of the original data while crediting the individual researcher or recorder. Another possibility to search for these data is via the 'EDIT Specimen and Observation Explorer for Taxonomists' developed as part of EDIT WP5 activities (Zippel *et al.*, 2009). Further to these presentations of data for scientists and other users, all primary data generated through the project are also provided directly to the park and relevant authorities, which can directly incorporate the data into their geographic information systems and other applications for more effective park management. The availability of new, accurately timed and geo-referenced, digital biodiversity data greatly enhances capabilities for efficient and timely protected area management, at least for the active ATBI+M pilot sites.

3. First experiences from EDIT ATBI+M pilot sites

EDIT has established between 2007 and 2008 two larger European ATBI+M pilot sites, which both remain fully operational. The first pilot site comprise the Natural Parks Mercantour (France) (Fig. 2A) and Alpi Marittime (Italy) (Fig. 2B), and the second one is located in the Gemer region (Slovakia). The latter is composed of the three Slovakian National Parks "Muránska Planina", "Slovenský Kras", and "Slovenský Raj" (Fig. 3).

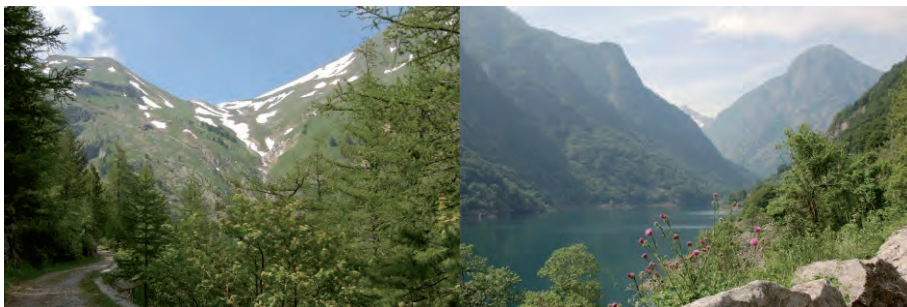

Fig. 2. A. Impression of Mercantour National Park. **2. B.** Impression of Alpi Marittime National Park. (Photos by Anke Hoffmann).

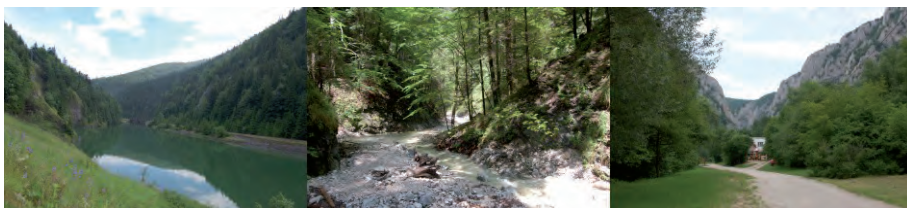

Fig. 3. Impressions of the Gemer area (Photos by Anke Hoffmann).

More detailed information about these European ATBI+M pilot sites can be found on the following dedicated EDIT and park websites:

Mercantour/Alpi Marittime: www.atbi.eu/mercantour-marittime

Gemer: www.atbi.eu/gemer

Mercantour: www.mercantour.eu

Alpi Marittime: www.parks.it/parco.alpi.marittime/Eindex.html

Muránska Planina: www.gemer.sk/ciele/mplanina/en.html

Slovenský Kras: www.gemer.sk/ciele/skras/en.html

Slovenský Raj: www.slovenskyraj.sk/en.html

3.1. ATBI+M pilot site Mercantour / Alpi Marittime (France / Italy)

Following the signing of a Memorandum of Understanding between representatives of the Mercantour and Alpi Marittime Natural Parks and EDIT, activities at this bi-national ATBI+M site started in 2007. Since its establishment participation at this site has constantly increased, especially for the number of involved scientists (Fig. 4). As of December 2009, 170 scientists from 12 countries (42 institutions) had visited the two parks having spent a total of 1,561 field days. During this time period, a total number of 4,772 species have been recorded and 25,583 individual data sets on their distribution within the parks have been delivered (Fig. 5). The strong increase in both the number of recorded species and data sets between 2007 and 2008 is explained by the time needed to identify the collected specimens, usually during winter and spring. Still a good number of data sets are expected to be delivered until the spring of 2010 and field surveys during the vegetation period of this year will result in a further increase of both the number of recorded species and individual data sets.

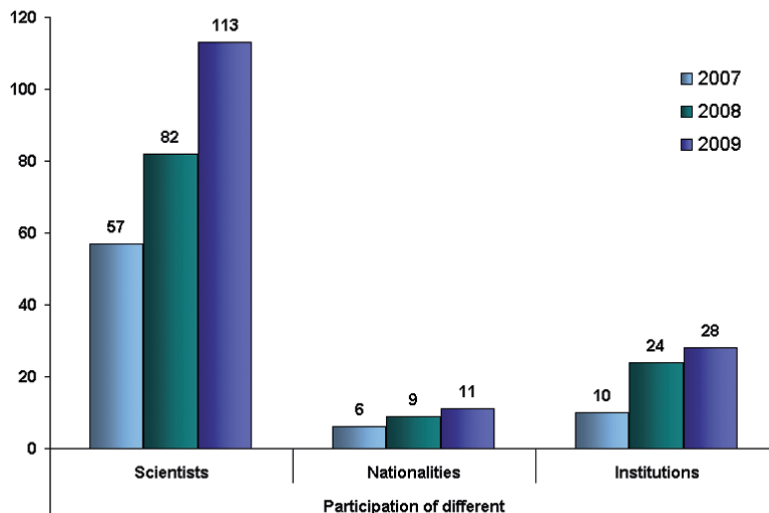

Fig. 4. Participation at the ATBI+M pilot site Mercantour / Alpi Marittime (2007 – 2009).

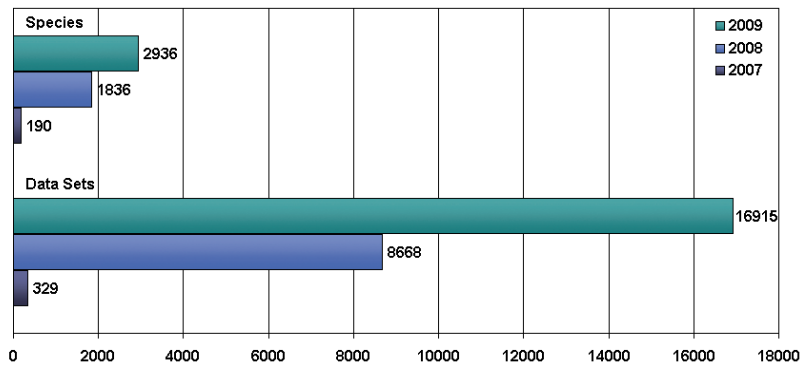

Fig. 5. Number of identified species and delivered data sets and their annual distribution (2007 – 2009) for Mercantour / Alpi Maritime pilot site.

Animals comprise almost two thirds of the reported species ($n = 3092$, Fig. 6), with insects being the largest represented group (91.1%). The insect groups with the highest species numbers recorded so far correspond to the Lepidoptera ($n = 1890$), and the Coleoptera ($n = 489$). In summary, important additions to the knowledge on the flora and fauna of this ATBI+M pilot site have been achieved so far:

- 59 new species records for the parks;
- 33 new species records for France/Italy;
- 2 species, at least, new to science.

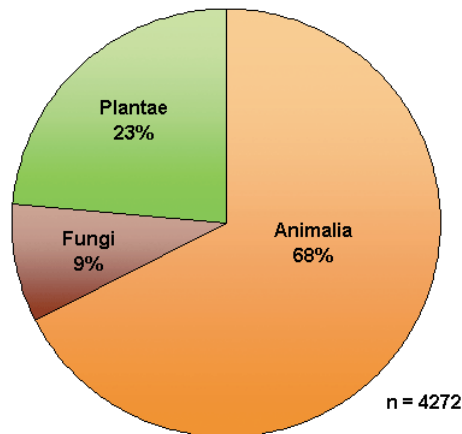

Fig. 6. Proportion of records for different kingdoms for total number of species for Mercantour / Alpi Maritime pilot site.

Individual data sets of all recorded species can be found on the Mercantour/Alpi Maritime website www.atbi.eu/mercantour-maritime/ under "park biodiversity" and "taxonomic details". At the GBIF portal, the respective data are available at: data.gbif.org/datasets/resource/7949/.

3.2. ATBI+M pilot site Gemer region (Slovakia)

In January 2007, the Memorandum of Understanding was signed by representatives of EDIT and the Slovakian national nature conservancy, and field activities started fully in 2008. Up-to-date 39 researchers from 12 countries (26 institutions) have visited 75 times the ATBI+M Gemer area, and have spent more than 500 days in the field. From 2008 to 2009 the amount of field days has increased by 67%. The main focus of research was on the Muránska Planina National Park, only a third of the research was pursued in the two other National Parks of the Gemer area. In 2009, the interest for Slovenský Raj and Slovenský Kras has increased, but further promotion for those sites is needed. The preference by researchers for the Muránska Planina National Park is probably based on the ideal logistics at this site, which includes a field station (Fig. 7). The field station with some laboratory infrastructure is part of the information centre of the Muránska Planina National Park at Murán village, where accommodation is also available for participants.

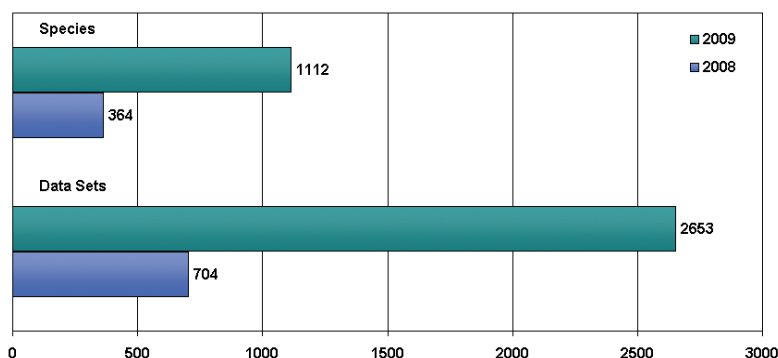

Fig. 7. Number of identified species and delivered data sets and their annual distribution (2007 – 2008) for the Gemer ATBI+M pilot site.

So far, a total of 1,360 species (3,357 data sets) have been documented for the Gemer ATBI+M pilot site to date (Fig. 8). Animals represent more than half of all recorded species ($n = 751$) (Fig. 9), whereas 83% of this group are made up of insects, mainly Diptera ($n = 318$) and Lepidoptera ($n = 305$). These results indicate that there is still a high demand for further experts targeting other groups at the Slovakian ATBI+M sites. Individual data sets of all recorded species can be found on the EDIT Gemer website: www.atbi.eu/gemer/ under "park biodiversity" and "taxonomic details". At the GBIF portal, the respective data are available at data.gbif.org/datasets/resource/7950/.

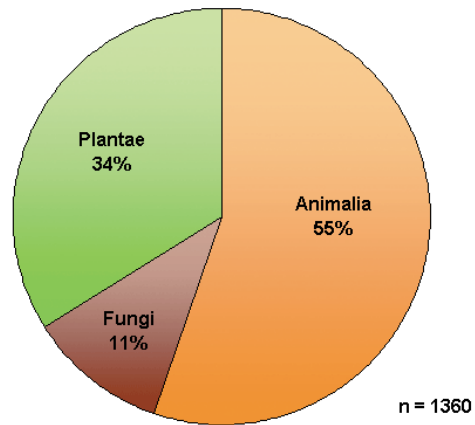

Fig. 8. Proportion of records for different kingdoms for total number of species for the Gemer ATBI+M pilot site.

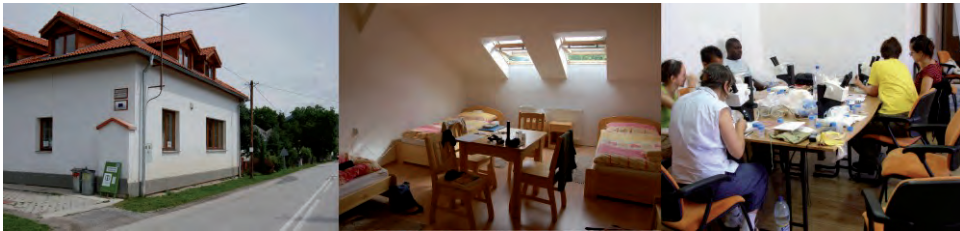

Fig. 9: Field station for ATBI+M participants in Murán village. (Photos by Lellani Farinas and Anke Hoffmann).

4. References

- GODFREY, H.C.J. 2002. Challenges for taxonomy. *Nature* 417: 17-19.
- GOLDING, J.S. & TIMBERLAKE, J. 2003. How Taxonomists Can Bridge the Gap Between Taxonomy and Conservation Science. *Conservation Biology* 17(4): 1177-1178.
- HÄUSER, C. L. RIEDE, K. & BOS, M. 2007. Second Workshop on ATBI+M: Data recording methods and extra-European site selection. *EDIT Newsletter* 2: 9-10.
- HÄUSER, C.L., KROUPA, A., MONJE, J.C. & EYMANN, J. 2009. Taxonomic Expertise and New Tools for Biodiversity Inventory and Monitoring of Conservation Areas: The EDIT ATBI+M approach. *Mitteilungen der Deutschen Gesellschaft für allgemeine und angewandte Entomologie* 17: 343-346.
- HENRY, P.-Y., LENGYEL, S., NOWICKI, P., JULLIARD, R., CLOBERT, J., CELIK, T., GRUBER, B., SCHMELLER, D. S., BABIJ, C. & HENLE, K. 2008. Integrating ongoing

biodiversity monitoring: potential benefits and methods. *Biodiversity and Conservation* 17: 3357-3382.

JANZEN, D.H. & HALLWACHS, W. 1994. All Taxa Biodiversity Inventory (ATBI) of Terrestrial Systems: A Generic Protocol for Preparing Wildland Biodiversity for Non-Damaging Use. *Report of a National Science Foundation Workshop*, 16-18 April 1993, Philadelphia, Pennsylvania.

LA SALLE, J., WHEELER, Q. D., JACKWAY, P., WINTERTON, S., HOBERN, D., LOVELL, D. 2009. Accelerating taxonomic discovery through automated character extraction. *Zootaxa* 2217: 43-55.

MAYO, S.J.R. ALLKIN, R., BAKER, W., BLAGODEROV, V., BRAKE, I., CLARK, B., GOVAERTS, R., GODFRAY, C., HAIGH, A., HAND, R., HARMAN, K., JACKSSON, M., KILIAN, N., KIRKUP, D.W., KITCHING, I., KNAPP, S., LEWIS, G.P., MALCOLM, P., VON RAAB-STRAUBE, E., ROERTS, D.M., SCOBLE, M., SIMPSON, D.A., SMITH, C., SMITH, V., VILLALBA, S., WALLEY L. & WILKIN, P. 2008. Alpha e-taxonomy: Responses from the systematics community to the biodiversity crisis. *Kew Bulletin* 63: 1-16.

MALLET, J. & WILLMOTT, K. 2003. Taxonomy: renaissance or Tower of Babel? *Trends in Ecology & Evolution* 18: 57-59.

MCNEELY, J.A. 2002. The role of taxonomy in conserving biodiversity. *Journal for Nature Conservation* 10(3): 145-153.

NEW, T.R. 1996. Taxonomic focus and quality control in insect surveys for biodiversity conservation. *Australian Journal of Entomology* 35(2): 97-106.

POLASZEK, A. 2005. A universal register for animal names. *Nature*, 437: 477.

ROSEN, D. 1986. The role of taxonomy in effective biological control programs. *Agriculture, Ecosystems & Environment* 15: 121-129.

SCHLICK-STEINER, B., STEINER, F.M., SEIFERT, B., STAUFFER, C., CHRISTIAN, E. & CROZIER, R.H. 2010. Integrative Taxonomy: A multisource approach to exploring biodiversity. *Annual Review of Entomology* 55: 421-438.

SCOBLE, M.J. 2004. Unitary or unified taxonomy? *Philosophical Transactions of the Royal Society of London, Biological Sciences* 359(1444): 699-710.

SHARKEY, M.J. 2001. The All Taxa Biological Inventory of the Great Smoky Mountains National Park. *Florida Entomologist* 84(4): 556-564.

SOBERÓN, J. & PETERSON, A.T. 2009. Monitoring Biodiversity Loss with Primary Species-occurrence Data: Toward National level Indicators for the 2010 Target of the Convention on Biological Diversity. *Ambio* 38: 29-34.

TILLIER, S., BERENDSOHN, W., ENGHOFF, H., HÄUSER, C.L., LOS, W., RAMOS, M., SCOBLE, M. & VAN GOETHEM, J. 2005. The European Distributed Institute of Taxonomy (EDIT): a network for integration of taxonomy supported by the European Commission. *In: Secretariat of the Convention on Biological Diversity (ed). Success Stories in Implementation of the Programmes of Work on Dry and Sub-Humid Lands and the Global Taxonomy Initiative*. CBD Technical Series, 21. Secretariat of the Convention on Biological Diversity, Montreal: pp. 127-128.

WHEELER, Q.D. & VALDECASAS, A.G. 2005. Ten challenges to transform taxonomy. *Graellsia* 61(2): 151-160.

WHITE, P. & LANGDON, K. 2006. The ATBI in the Smokies: An overview. *The George Wright Forum* 23: 18-25.

ZIPPEL, E., KELBERT, P., KUSBER, W.-H., HOLETSCHEK, J., GÜNSCH, A. & BERENDSOHN, W. 2009. EDIT Specimen and Observation Explorer for Taxonomists – Eine nützliche Komponente der taxonomischen EDIT-Arbeitsplattform im Internet. *GfBS Newsletter* 21: 18-21.

Chapter 3

Challenges and solutions for planning and implementing large-scale biotic inventories

by

Maurice Leponce

Royal Belgian Institute of Natural Sciences
29 rue Vautier, 1000 Brussels, Belgium
Email: maurice.leponce@naturalsciences.be

Christopher Meyer

National Museum of Natural History
PO Box 37012, Washington DC 20013, USA
Email: meycrc@si.edu

Christoph L. Häuser

Museum für Naturkunde Berlin
Invalidenstr. 43, 10115 Berlin
Email: Christoph.Haeuser@mfn-berlin.de

Philippe Bouchet

Muséum National d'Histoire Naturelle
55 rue Buffon, 75005 Paris, France
Email : pbouchet@mnhn.fr

Jacques Delabie

Centro de Pesquisa do Cacau, Convênio UECS-CEPLAC
Caixa Postal 7, 45600-000 Itabuna, Bahia, Brasil
Email : jacques.delabie@gmail.com

Lee Weigt

National Museum of Natural History
PO Box 37012, Washington DC 20013, USA
Email: weigtl@si.edu

Yves Basset

Smithsonian Tropical Research Institute
Apartado 0843-03092, Balboa, Ancon, Panama City, Republic of Panama
Email: bassety@si.edu

Abstract

To date, there is still no complete or near complete information on the total biodiversity of any species-rich ecosystem around the world, even in protected areas. The benefits from biodiversity resources and healthy ecosystems are best garnered if those species and interactions are well known. Large-scale inventories can maximize the biodiversity information collected through the coordinated effort of a multidisciplinary team. Large-scale inventories may produce an overall picture of highly complex ecosystems and may be instrumental for conservation and management decisions. The taxonomic coverage of the survey may vary from all taxa present in an area (All Taxa Biodiversity Inventory, ATBI) to a selected range of them. Comprehensive biodiversity inventories basically face four kinds of challenge. First, biological challenges, as species distributions are heterogeneous in space and time. Representative results may thus only be achieved with adequate spatio-temporal replicates. Second, methodological challenges, since any sampling method provides a biased image of species composition and abundance. The use of complementary collecting methods helps to circumvent this problem. Third, taxonomical challenges, as large inventories generate an impressive amount of material to process and identify. To avoid work overload of expert taxonomists the material should be pre-processed by assistants (students, amateurs, parataxonomists, volunteers) supervised by professionals. Fourth, planning and implementation challenges, since security and legal issues, coordination of collection and processing of material, centralization of data, and follow-up of the project may not be straightforward. An ideal implementation requires an organizational structure composed of coordinators, advisors, workgroups and external partners. Comprehensive inventories typically span over several years. To keep the motivation of participants and of stakeholders the project output should include fast deliverables in addition to long-term research. Finally, the value and complementarity of large-scale inventories in terms of global biodiversity coverage and of scientific investigations may be increased by incorporating them into global networks of permanent sites.

Keywords: All Taxa Biodiversity Inventory, sampling design, project coordination, DNA barcoding.

1. Taxonomic, spatial and temporal extent of large-scale inventories

Large-scale biotic inventories differ in their size and ambition. The major factors differentiating All Taxa Biodiversity Inventories (thereinafter referred to as ATBIs) can be defined by three axes: taxonomic scope, geographic extent, and sampling frequency. Taxonomic coverage can vary from all taxa present in an area to a selected range of them, often limited by specimen size or phyletic affinity. Geographic coverage may range from an entire country, down to an island or park scale. Finally, temporal coverage may vary from an inventory at a single time slice to annual or multi-year surveys.

To date, there is still no complete or near complete information on the total biodiversity of any species-rich ecosystem around the world, even in protected areas. Microcosms, caves and other self-contained and relatively species-poor ecosystems may represent exceptions (e.g Small, 1998). In the past, the largest inventory carried out may well have been the monumental collections needed for the encyclopedia "Biologia Centrali Americana" (DuCane Godman & Salvin, 1879-1915, free digital edition available on the web at <http://www.sil.si.edu/digitalcollections/bca/>). During this inventory, many collectors were employed specifically to accumulate material from Mexico and Central America. Over a 36 year period, this work described over 50,000 species of animals and plants, one third of which were new.

The first ATBI (Janzen & Hallwachs, 1994) was initially planned by Daniel Janzen for the Area de Conservación Guanacaste in Costa Rica, but for financial and political reasons this endeavour changed into a survey focused on Lepidoptera, their parasites and gut micro-organisms (Janzen, 1988; Gámez *et al.*, 1997; Sharkey, 2001; White & Langdon, 2006). The concept was then applied to a temperate area in the Great Smoky Mountains National Park, USA (Nichols & Langdon, 2007).

The goal of an ATBI is to collect and disseminate useful data on all species collected in a specific area (Nichols & Langdon, 2007). In this concept, "all species" mean in fact "as many as practical", and "useful data" refer to the collection of as much collateral information as possible on species' relative abundance, distribution, natural history and ecology. Such huge data collection effort is in principle concentrated over a limited amount of time. White & Langdon (2006) calculated that a comprehensive inventory in the Great Smoky Mountain National Park would take about 150 years without an ATBI approach. Janzen & Hallwachs (1994) initially recommended a five-year period to demonstrate the desirability and usefulness of the ATBI concept without losing the momentum, the motivation of participants and, possibly, many species through local extinctions.

Currently there are only a few ongoing ATBIs. The Great Smoky Mountain National Park ATBI (referred hereafter to as Smokies ATBI), which was officially initiated in 1998, covers an area over 2000 km². Launched in 2002, the Swedish Taxonomy Initiative (STI) aims to inventory all of Sweden's multicellular organisms, approximately 50,000 species, within 20 years (Ronquist &

Gärdenfors, 2003). Between 2006 and 2011, the Moorea Biocode Project (MBP) of French Polynesia will construct a vouchered library of genetic markers and physical identifiers for every non-microbe species on the island of Moorea (134 km²), including marine, freshwater and terrestrial habitats (Check, 2006). Starting in 2007, the European Distributed Institute of Taxonomy (EDIT) has identified a series of potential ATBIs in both temperate and tropical national parks (for detailed explanations see chapter 2).

Many large-scale inventories focus on a selected range of taxa or habitats rather than all present in a specific area. This is the case of local or global projects, especially when centred around research stations in the tropics (e.g. Arthropod of La Selva 1991-2005: Longino & Colwell, 1997; Manaus, Reserva Ducke: Adis *et al.*, 1998; Magnusson *et al.*, 2005). These efforts can be used to spearhead more comprehensive inventories once proof of concept is demonstrated. Additionally, large naturalist expeditions such as the Royal Geographical Society expedition of 1977-1978 in Sarawak, the Royal Entomological Society expedition of 1985 in Sulawesi (project Wallace: Knight & Holloway, 1990) or EDIT's SANTO2006 project in Vanuatu (Hanbury-Tenison & Jermy, 1979; Bouchet *et al.*, 2009) all involved more than 100 scientists, many scientific programmes, lasted several months, and included a large range of taxa. Other projects such as IBISCA-Panama (Investigating the Biodiversity of Soil and Canopy Arthropods) put a strong emphasis on the collaboration between different research teams coordinated to answer common scientific questions (Basset *et al.*, 2007).

Finally large-scale inventories of selected taxa should ideally be coupled with long-term monitoring programmes. Examples of suitable locations for this long-term task include the networks of the Smithsonian Institution Global Earth Observatories (www.sigeo.si.edu/), the National Ecological Observatory Network (www.neoninc.org), long-term ecological research stations (www.lternet.edu) or Conservation International's TEAM initiative (www.teaminitiative.org/). A crucial advantage of global networks includes the collection of biodiversity information using standardized methods, which allows between-site comparisons.

2. Challenges

Large-scale biodiversity inventories are challenging in many aspects:

- Species distribution is heterogeneous in space and time. Hence, data collected during studies restricted in space and/or time may not be representative of local biodiversity. *Solution: replicate your collection.*
- Collecting, identifying and processing specimens and analyzing the information require a wide expertise and substantial coordination between project participants. *Solution: plan carefully.*
- Processing of the material collected is very time-consuming (*i.e.*, costly), particularly when taxonomic coverage is wide and includes small organisms and species-rich groups (Lawton *et al.*, 1998).

- Taxonomic coverage of the project is unavoidably biased towards well-studied taxa or, at least, “non-orphan” taxa (*i.e.*, currently many species groups lack experts and this situation will get worst in the future).
- Taxonomy experts represent a scarce resource and are continuously overloaded with work (taxonomic impediment).
- The motivation of participants needs to remain focused on the project for a substantial time, typically a few years.
- Pristine habitats have virtually disappeared. The remaining undisturbed or little known habitats are generally difficult to access or are threatened by human activities. The number of suitable natural sites is therefore restricted or may be costly to access.
- Collecting and export permits (for the purpose of taxonomic studies) may be difficult to obtain for certain countries/locations.
- The colossal input and work involved is likely to slow down scientific output. Yet the project may need to rapidly demonstrate its scientific interest and deliver scientific products.

3. Importance and implementation of large-scale inventories

3.1. Importance

The benefits from biodiversity resources and healthy ecosystems are best garnered if those species and interactions are well known. Moreover, conservation decisions and the success of those efforts can only be measured if we have a baseline of what exists. Well-integrated, large-scale inventories constitute a cost-effective way to study our biodiversity resources through coordinated collaboration between researchers. Numerous benefits can be expected from these endeavours (Janzen & Hallwachs, 1994; Sharkey, 2001; White & Langdon, 2006; Nichols & Langdon, 2007):

- **Advances in fundamental science.** The identification of species, the study of their morphological and genetic variability, and the discovery of species new to science or new to the study area allow advances in taxonomy, systematics and biogeography. Large-scale inventory sites where many species are identified and where environmental conditions are well known are also ideal locations for studying species ecological interactions (including food webs) and the functioning of whole ecosystems. Finally, new scientific approaches can arise from the confluence of ideas and methods of the various specialists involved in the collective project.
- **Advances in applied science.** Reference checklists and maps of defined areas can be used as a baseline for conservation, management and monitoring. Inventories enable assessment of the type and level of threat to which species or habitats are exposed and to update red lists. Inventories allow detection of invasive species and documentation of natural or human disturbances (habitat modification, fragmentation and isolation, or pollutants).

They also provide fundamental information that is necessary for land management, especially for protected areas. For example, an analysis of presence/absence maps and GIS layers can help determine which biotic and abiotic conditions rare or sensitive species depend upon. This information can also forecast the impact of practices such as grazing, pest control, and road or corridor building (White & Langdon, 2006). Geographic analysis of multiple species distributions can be used for protecting sensitive sites or for locating monitoring activities at the most appropriate sites. Finally, large inventories constitute a baseline for monitoring. True decreases or increases in biodiversity can be distinguished from natural variations, and the cascade effects of the disappearance of ecologically important species in the ecosystem can be studied.

- **Education.** Large-scale inventories generate a large amount of information which is useful for various segments of the population: specialists, amateurs, general public, schools, ecotourists, artists, etc. (Sharkey, 2001; Hilten *et al.*, 2006). This is especially true if the data collected are made quickly available to the public through webpages and if voucher specimens of the species collected are centralised at a single location. Ideally specialists should benefit from the tools and infrastructure supplied by the project to build interactive keys and establish a library of photos, videos, sounds or other media including DNA sequences. These electronic tools are of great help to the amateur naturalist and the general public for identifying specimens and can be used to produce field guides of local fauna and flora. Science education programs can be articulated around ATBIs and proved to be very successful in the Great Smoky Mountains National Park (Hilten *et al.*, 2006). A website (www.smokymountainseft.org) offers downloadable activities, video and interactive games to explore the biodiversity of the Park.
- **Other utilities for economy and society.** As stressed by Janzen Hallwachs (1994) “the basic goal of an ATBI is to prepare a large body of biodiversity for non-damaging use by society”. The prospecting of genes, chemicals, structures and behaviours are useful for the progress of science, art and industry. Technology can also learn from solutions found in nature for a large range of problems (*e.g.* biomechanics, biomimicry). Living samples collected during inventories can supply banks of biological material (seed, sperm, tissue), biological control centres, zoos or botanical gardens. Large-scale inventories can also stimulate local development involving the sustainable use of biodiversity resources through ecotourism, bioprospecting and sound ecosystem management.

3.2. Implementation

Large-scale inventories are characterized by advanced coordination between researchers, concentrated research effort in reference sites, wide taxonomic coverage and a diverse spectrum of biological information collected.

The choice of the reference site will depend on the scientific questions targeted, the infrastructure available and the prior commitments in conservation, research and monitoring. For ATBIs, study sites should be protected areas with a

guarantee of long-term protection and of access for inventory activities. In this perspective, the long term survival of the biodiversity contained in the site increases if the site is large and includes climatic or altitudinal gradients (buffer against climate change) and if migrations to or from surrounding habitats are made possible by the presence of buffer zones and stepping stones (Janzen & Hallwachs, 1994). Large areas also allow more replication, less impact of inventory activities and inclusion of disturbed portions of the habitat representative of various degrees of restoration or regeneration (Janzen & Hallwachs, 1994). The inclusion of anthropogenic habitats is pertinent to evaluate the impact on biodiversity of improved management or regulation (e.g. new pollutant emission rules, access restrictions, catch-limits in marine protected areas, etc.).

The choice of taxonomic coverage will depend of the aim of the project and of the taxonomic expertise available. The data collected during large-scale inventories do not simply consist of a species list. Additional information about species abundance, spatio-temporal distribution, environmental conditions and life history are needed for better predictive modelling of species diversity, distribution and response to environmental changes. Estimates of population size and rarity are necessary to appreciate the endangered status of species. Because the life cycle, distribution and abundance of organisms are tied to climate, weather data should be collected during the general inventory. Depending on the organisms studied, other useful environmental measures include: soil quality, water quality, light intensity, etc. Whenever possible environmental data are collected automatically with recording instruments. The collection of these environmental variables leads to improved predictive models, directs additional sampling and allows for further testing and refinement of those models. Any large-scale project must also disseminate knowledge and experience to a wide audience and incorporate an education and communication plan in addition to the science plan (White *et al.*, 2000; Hilten *et al.*, 2006; Parker & Bernard, 2006). Practical issues linked to the planning and logistics of large-scale inventories are developed in the next sections.

4. Management

The administrative structure depends on the size of the project but is basically composed of:

- **coordinators.** A project leader and assistants are essential. The largest projects may require a directorate with a director supervised by a National Commission (Janzen & Hallwachs, 1994). Coordinators support and integrate the work of all project participants in order to achieve a common goal and vision and ensure the circulation of information between them.
- **workgroups.** Participants in large inventories can be experts in various disciplines: field collection, taxonomy, ecology, molecular techniques, data management, statistics, etc. These experts are best organized in workgroups headed by leaders. These leaders are responsible for a particular taxa, method or task. They supervise the work of the other members of the group, train less experienced participants and are responsible for the feedback of

information to the project coordinators. Coordinators minimize redundancy in data collection, overrepresentation of popular taxa or methods, and information gaps. They also plan the actions of the workgroups. Some workgroups depend on the results of others (e.g. a botanical survey is often a preliminary to an entomological survey, a vertebrate survey comes before a survey of their parasites, pathogens or symbionts) (Janzen & Hallwachs, 1994). Taxonomic Working Groups (called "TWiGs") can be organized according to their ease of study, collection methods, or expeditions. Taxonomic coverage basically depends on the actual knowledge and expertise available for the groups encountered, their ease of identification and of collection, and species richness and abundance (Janzen & Hallwachs, 1994; Sharkey, 2001). While some ecologically important organisms are easy to inventory (e.g. plants, social insects, etc.) others are unlikely to be inventoried to the species level (e.g. rotifers, wild plant viruses, etc.). However, DNA barcoding provides new opportunities for discriminating notoriously difficult groups or cryptic species.

- **international advisory committee.** This committee discusses project planning, monitors its progress and makes recommendations to its coordinators. Success should be measured according to established benchmarks. Its competence can be related to science, education or development.
- **partners and companion structures.** Scientific partners of the project can be universities, museums, research institutes, or park administrations. Some projects are too large to be managed by any one of these partners. In this case they can be managed by a NGO (e.g. Conservation International for the TEAM initiative, Pro-Natura International for IBISCA projects), a private non-profit organization (e.g. Discover Life In America for the Great Smoky Mountains ATBI) or an international public project (e.g. EDIT's ATBIs) (White & Langdon, 2006). These companion structures administer and coordinate the inventories and develop resources and partnerships. Sponsors can be public or private partners. Often it is helpful to include a consortium of stakeholders or a set of local partners that have a vested interest in the heritage of the region and a sense of long-term stewardship.

5. Planning

5.1. Duration and budget

The general goals of the project must be achievable in a reasonable amount of time and include fast deliverables to maintain the motivation of stakeholders. Examples of such deliverables include dynamically updated websites, frequent progress reports, assistance to management and conservation decisions, scientific publications, and identification guides for the public.

A full-scale ATBI is a major effort that requires significant but still reasonable resources compared to the budget of the human genome project or of the 2010 football world cup (both around 3 US\$ billion). To support the Smokies ATBI, approximately US\$ 1.8 million has been received by individual scientists in

several grants. In addition, approximately US\$ 120,000 per year has been received from local sources, which was “seed money” so researchers could leverage an additional approximately US\$400,000 per year in services and sometimes funding. So far, in 11 years 6400 species have been documented in the park, 15% of them being species new to science. The Smokies ATBI database currently includes 300,000 geographic records essential to mapping distributions and understanding ecological connections. The Moorea Biocode Project is supported by a US\$5.2 million grant and EDIT’s SANTO2006 budget was € 1.2 million. However, these values do not reflect the full costs of such large-scale inventories. The salaries of the participating scientists are not included (they are covered by their institutions) and many of the costs for post-collection events such as processing of the material, databasing, storage of collections, taxonomic studies (including visits to museum’s collections), are assumed by the holding institutions. As an illustration of this, the total cost of the 2009-2010 Madagascar/Mozambique inventory organized by the French National Museum of Natural History and Pro-Natura International is ca. 4 million € of which 2,5 million € is in cash and the remainder taking the form of in-kind contributions. Considering the huge amount of biological material collected a substantial budget for these post-collection tasks must be secured to assure success. This represents a guarantee that the project will deliver a minimum scientific output within a reasonable time frame. It may also be useful to include in the budget “seed grants” that may facilitate the access to other sources of funding for participants (White & Langdon, 2006).

5.2. Sampling design

The task of documenting the diversity and distribution of species in a given area faces three kinds of challenges: biological, methodological and taxonomical.

5.2.1. Biological challenges

The distribution of species is heterogeneous in space and time (Fig. 1). The scale of this heterogeneity depends of the organism studied. To obtain a representative biodiversity inventory, spatial and temporal replicates are therefore necessary.

Spatial replicates are best conducted through a stratified sampling encompassing various spatial scales, with replications at each scale (Table 1, iBOL Barcoding Biotas Working Group, 2009). The rationale behind this approach is that the distribution of organisms is often related to the distribution of their resources (*i.e.* food, nesting sites). Stratified sampling allows measuring the diversity partitioned within the habitat studied. Vertical sampling is of particular importance in multi-layered habitats such as forest canopies or soils (Basset *et al.*, 2003a; André *et al.*, 2002). For example, a study in Gabon indicated that, for a particular time period, forest strata explained a higher fraction of variance in the distribution of species of insect herbivores than location *per se* in the forest or diel activity (73%, 19% and 8% of the variance explained, respectively; Basset *et al.*, 2001).

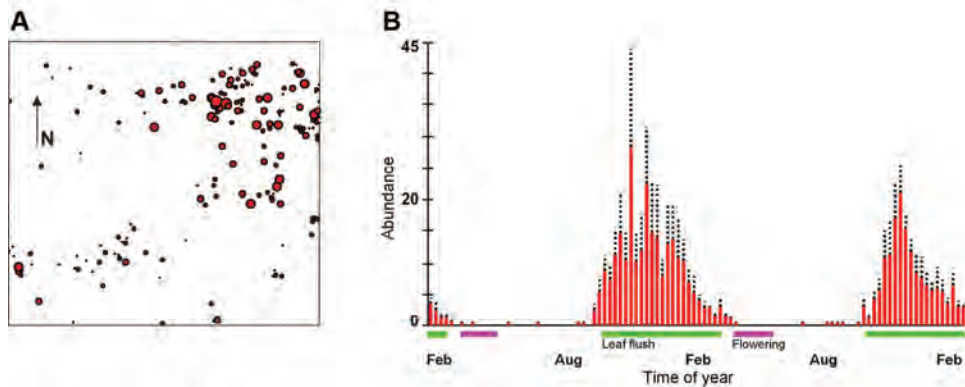

Fig. 1. Illustration of the spatio-temporal heterogeneity of species distribution. A. Variability of the spatial distribution of a highly generalist leafhopper, *Soosiulus fabricii* Metcalf (Hemiptera: Cicadellidae), in a plot of 1 km² in Guyana. The size of the bubbles is proportional to the mean abundance of specimens collected at each station. B. Variability of the abundance of an insect group associated to the resource availability in a tropical rainforest. Weekly number of Chrysomelidae (Coleoptera, herbivore) collected with respect to host leaf flush and flowering (solid bars represent means and broken lines standard errors). (Source: Basset, 1991, 2000).

Temporal replicates should be conducted at least during one year to document the seasonal variation of species distribution, relative abundance, and all life stages of the organisms present. If time is restricted, the priority may be to collect during a period of high biological activity (but background information is required to achieve this). Nycthemeral cycles should be particularly taken into account when sampling organisms whose activity is much affected by light or temperature.

A structured sampling approach (such as the stratified sampling presented in the previous paragraph) allows quantification of biodiversity and therefore statistical comparisons among sampling units, sites, or seasons. However not all taxa are reliably sampled by sampling devices (e.g. traps) used in a structured approach. Therefore a complementary approach is traditional sampling conducted by experienced taxonomists who rely on tacit knowledge of their target taxa to effectively locate them. “Bio-blitzes” that bring together large numbers of experts and volunteers are sometimes organized during a short period of time to collect a large amount of specimens of the target taxa (Nichols & Langdon, 2007). It should be noted that some sampling protocols are a mixture of the structured and traditional approaches (e.g. termites which are collected by visual search along transects: see Jones & Eggleton, 2000; Roisin & Leponce, 2004). In general comparison of the results obtained from the traditional and structured sampling approaches gives some indications on the completeness of the inventory (Nichols & Langdon, 2007).

Habitats	Vertical strata	Microhabitats
	Forest	
	Canopy	Leaves Flowers & fruits Bark Epiphytes ...
	Understorey	cf. canopy
	Ground surface	Leaf litter Dead wood ...
	Soil	Humus Roots ...
	Ecotone forest/grassland	cf. forest
	Grassland	cf. forest ground and soil

Table 1. Example of stratified sampling in a hypothetical simplified landscape composed of two terrestrial habitats: a forest and a grassland. The number of subdivisions is non exhaustive and depends of both the habitat characteristics and the type of organisms targeted. For example the microhabitat scale presented here is relevant for arthropods but not for plants.

The identification of immature stages of animals or of plants at a period of the year during which they do not show any useful characteristics (flowers, fruits, leaves) is often problematic. DNA barcoding techniques are becoming increasingly efficient and affordable to solve this problem (Janzen *et al.*, 2005; Hajibabaei *et al.*, 2005; Kress *et al.*, 2005; Schlick-Steiner *et al.*, 2010).

5.2.2. Methodological challenges

In many cases inventories will only collect a fraction of the species present in the landscape because of problems of catchability. Some species are difficult to collect because they are geographically, temporarily or even methodologically rare (Novotny & Basset, 2000; Longino *et al.*, 2002; Novotny *et al.*, 2007). Some habitats such as the canopy or the soil are notoriously difficult to sample and require specialized techniques (André *et al.*, 2002; Basset *et al.*, 2003b; Basset *et al.*, 2007). In practice this results in incomplete surveys and biased samples due to undersampling (Coddington *et al.*, 2009), two common traits of any ATBI. Sampling protocols must be developed and adjusted to mitigate these effects. Completeness and bias of the survey can be easily evaluated by analyzing the data matrix (taxa by sample) with a popular freeware called EstimateS (Colwell, 1994).

- **Evaluation of sampling completeness.** Assessing sampling completeness during data collection helps to assess the cost-effectiveness of the inventory and to decide when to stop collecting. Sampling completeness can be evaluated by calculating rarefaction curves plotting the number of species that are statistically expected to be found after collecting a given number of samples (or individuals). Sample-based curves are convenient to assess the number of samples required to reach a given level of inventory completeness (Fig. 2A). A common problem encountered with species rich taxa is that the rarefaction curve does not reach a plateau even after a considerable sampling effort. A useful tip to evaluate if the rarefaction curves approaches a plateau is to use a logarithmic scale for the abscissa and to see if the number of rare species (singletons) decrease at the end of the inventory (Fig. 2B) (Longino, 2000; Longino *et al.*, 2002). Individual-based rarefaction curves are suitable to compare taxon richness among assemblages (Gotelli & Colwell, 2001). When the sampling is incomplete, various techniques exist to estimate the total number of species in the assemblage: parametric, non-parametric and curve-fitting methods (Colwell & Coddington, 1994; Chazdon *et al.*, 1998; Longino *et al.*, 2002; Walther & Moore, 2005). A simple method such as the non-parametric Chao1 or Chao2 is useful to estimate the total species richness (Fig. 2A). These estimators are directly calculated with EstimateS, are conservative (give a minimal value) and can be coupled with the calculation of the number of samples needed to obtain the total number of species that they predict (Chao *et al.*, 2009).
- **Evaluation of sampling bias.** Typically a collection method collects only a fraction of the species present in the assemblage (Fig. 2C) and gives a biased image of the true relative occurrence/abundance of species (Fig. 2D). A solution to mitigate these effects is to multiply the collection methods and focus on the most effective, simple, cheap and complementary techniques.

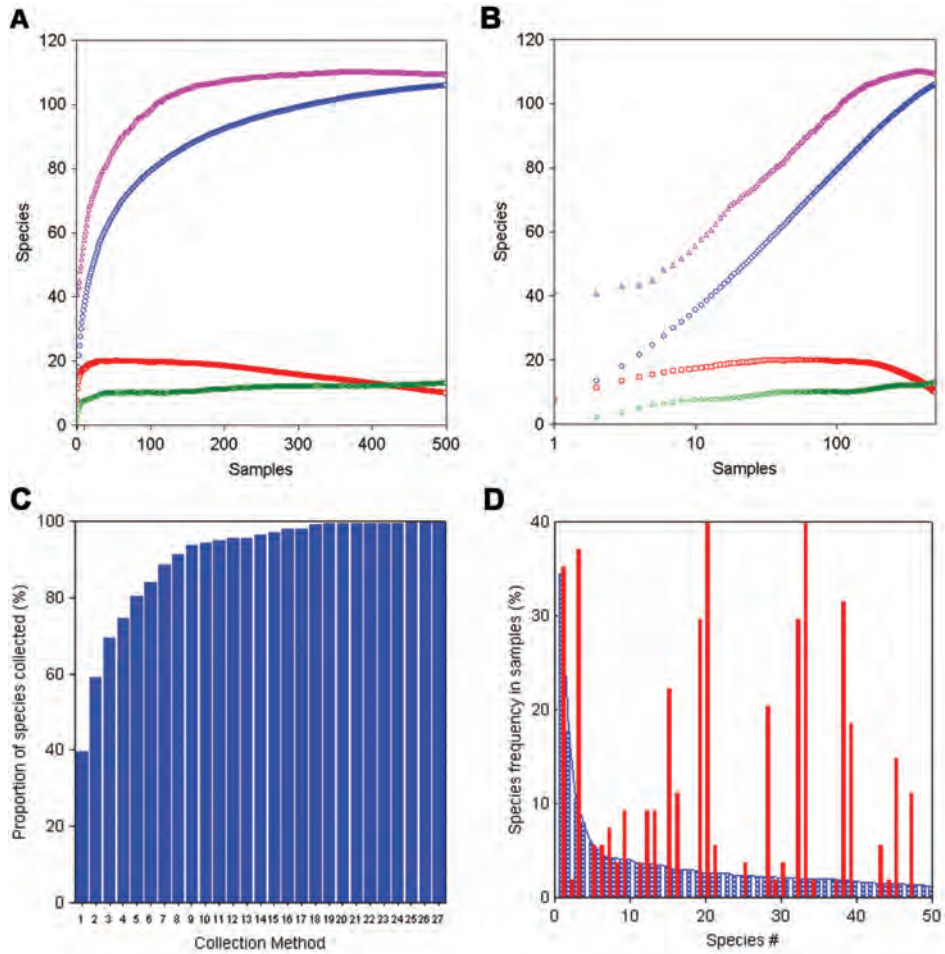

Fig. 2. Evaluation of inventory completeness of a species assemblage (A and B), of efficiency – in terms of fraction of species present collected- (C) and representativeness – in terms of species relative frequency- (D) of sampling methods used. A. Sample-based rarefaction curve (*i.e.* randomized species accumulation curve) allowing to assess sampling completeness. If the survey approaches near-completion the curve of singletons (*i.e.* rare species, represented in the sampling by a single individual, red curve) decreases and the rarefaction curve tends to reach a plateau. Associated with the decrease of singletons, the number of doubletons (*i.e.* rare species, represented by only 2 individuals, green curve) increases. B. These trends are more visible when a logarithmic scale is used for the abscissa. C. Cumulative proportion of species collected by more or less complementary sampling methods illustrating the fact that each method collects only a fraction of the local assemblage. For example method no. 1 collects 39% of the species present and 60% when combined with method no. 2. D. Comparison of the best approximation of each true species frequency (value ranging from 0.1 to 100.0%, calculated on the basis of the 27 collection methods from Fig. 2C, blue striped bar) with the value obtained by a single method (red bars) (first 50 samples ranked by decreasing true frequency shown). For example, method no. 1 seems to give a representative value of the frequency of the most common species (no. 1), but vastly underestimates the frequency of species no. 2. (Datasets presented in Delabie *et al.*, 2000, 2007).

5.2.3. Taxonomical challenges

Large inventories generate an impressive amount of material to identify. At the same time the number of professional taxonomists working in museums and universities is declining (Hopkins & Freckleton, 2002; Godfray, 2002; Miller *et al.*, 2004; Leather, 2009). A solution to relieve the work of the expert taxonomist is to rely on assistants who can sort, prepare and morphosort specimens. Specimens collected by selective methods (*e.g.* plants collected by botanists) are directly chosen in the field by the dedicated workgroup(s). The pre-processing of the material collected by non-selective methods (*e.g.* mass collection with entomological traps) is best conducted on site when workgroup leaders are all present during a collection episode (see 5.4.7). This allows them to supervise directly the sorting and pre-identification of the material to higher taxa levels and its dispatching to the appropriate taxonomic workgroup (Fig. 3).

Four categories of assistants can be distinguished: biology students, amateur taxonomists, parataxonomists and volunteers. Depending of the circumstances the inventory can employ one or several of these categories. Assistants must be trained, supervised and rewarded for their activity.

Biology students can find opportunities to gain professional experience and establish contact with a large network of professionals. Grants for a master or PhD thesis will be more easily obtained if ecological or evolutionary hypotheses are tested in addition to the purely taxonomic work. Enthusiastic secondary level students can also find an opportunity to have a work experience.

Experienced **amateur taxonomists** constitute an important workforce in temperate latitudes. They are highly motivated. Usually they expect doubles of the specimens for their private collection. Such situation requires that they subscribe to the general terms of involvement of the participants project (see 5.4.1). In some instances, a naturalist association can be a satellite structure supporting the inventory work. In this case a contract has to be signed between the association and the inventory project to guarantee the release of the data and specimens.

A **parataxonomist** is “a resident, field-based, biodiversity inventory specialist who is largely on-the-job trained out of the rural work force and makes a career of providing specimens and their natural history information to the taxasphere, and therefore to a multitude of users across society” (Janzen, 2004). The use of parataxonomists has proved to be very successful in a number of projects (Basset *et al.*, 2000, 2004; Janzen, 2004). Because they live near the study site, they are a potential source of natural history information and can easily be in charge of further field sampling and monitoring.

Volunteers are “citizen scientists” happy to collaborate on a scientific project and who have variable degrees of taxonomic expertise or interests. Other (non-taxonomic) skills they have can also be very valuable for the project (experience in databasing, web page development, illustration, photography, fund raising, administration, outreach, etc.). Volunteers have been a major assistance to the Smokies ATBI since it began (White & Langdon, 2006).



Fig. 3. Collection and processing of specimens. A. Collection of samples (here suspended soil in the tree canopy). B. Extraction of the fauna from the sample (Berlese-Tullgren apparatus). C. An assistant sorts the material extracted into major taxa. D. The corresponding subsamples are dispatched to taxonomic workgroups. E. Each taxonomic workgroup leader organizes the identification. F. The databasing of the information related to its taxa of interest. Images from the IBISCA-Panama project. (Pictures by H.-P. Aberlenc, S. Ribeiro, R. Le Guen / Panacoco).

5.3. Preparation phase

During the preparation phase, background information about the study site is collated and made available electronically to the project participants. This includes biological, physical, sociological, historical, and administrative information (Janzen & Hallwachs, 1994). More global information, for example existing general sources of information on the fauna, flora or habitats of the region are added too. Existing maps, aerial or satellite images, and GIS layers are of special interest to pre-select study plots. Weather and soil data are particularly important to plan ecological studies. Legal data are needed about the local regulations related to the collection and exportation of biological materials. Part of the information may not be readily available under a published form. Interviews of residents or neighbours can provide useful historical information about the presence of organisms and about natural (hurricanes, floods, and landslides) or human disturbances (e.g. previous land use) that occurred at the study site. Land owners and local authorities must be contacted to obtain all required authorizations and also to secure support from local communities.

Prior to the start of the project, a pilot study allows adjustment of sampling protocols (e.g. according to the habitat heterogeneity or phenology of the organisms), validation of plot locations inside the study site, and trial runs of database systems. During the preparation phase, priority surveys can be initiated (e.g. botanic surveys in study plots). In cases where DNA barcoding is also included, careful plans should be made before and during its execution to minimize genetic degradation (see chapter 7 and appendix I).

5.4. Execution phase

Once budgets have been secured, protocols have been defined and tested, and background information has been accumulated, the execution phase can start. Experts in various disciplines are then invited to participate to the project. A key to the collective success of the project is that participants adhere to some rules.

5.4.1. Terms of engagement of participants

Participants must agree to follow the 'rules of the club' which basically are:

- To minimize environmental impact: perturbations associated with collecting, observing or sampling the site biodiversity should be kept as close as possible to natural level (*i.e.* should not induce unusual levels of population fluctuations) (Janzen & Hallwachs, 1994). Interferences with the organization of local human communities should be reduced too.
- To accept the logistical, financial and security constraints: *i.e.* to support as agreed part or the totality of costs related to food, accommodation, transport, lab or other infrastructure and to respect the conditions of access to these infrastructures.

- To facilitate collegial activities: *i.e.* to collaborate to the coordination of field and laboratory activities, to share information and material with other participants.
- To accept the responsibility of delivering data and specimens according to the schedule agreed with the project coordinators. This is sometimes a prerequisite for the reimbursement of part of their expenses by the project organization. The data must be provided in a format compatible with the collective database. Specimens should be deposited in major museums to ensure their long-term conservation and accessibility. Ideally voucher specimens should be available in the form of a reference collection accessible locally, near the study site, and globally in the form of an interactive image database.

5.4.2. Central database

The scientific impact of the inventory clearly depends on the cooperation between participants and on the sharing of the data collected. The knowledge of the concurrent distributions of multiple taxa in an ecosystem is of great value in terms of conservation and for understanding the biology and ecology of the organisms present. The central database (Fig. 4) is supervised by an administrator who is responsible for the data integrity of the whole project. This is only possible if all participants use the same data organizational schema (*e.g.* collecting event, higher taxa, etc.). This implies an exchange of information between the database administrator who has to circulate standardized data fields and identifiers, and the survey participants who have to provide the basic information.

Broadly, this involves the following categories:

- **Collecting events.** This information includes the “where” and “when” components. Even if planned ahead during the general sampling design (*e.g.* plots or transects), participants must provide or validate some information (*e.g.* time and date, collector, method, habitat description, and other additional information such as images).
- **Specimens.** This set of information pertains to “what”. If the central database does not already include a complete list of higher taxa (taxa that ranks above than the species level), participants should provide their own list of taxa of interest. Participants must also provide the list of taxa that they identified in their samples. If several taxonomists identify specimens of the same higher taxa, the taxonomic workgroup leader must standardize the same system of codes (*i.e.* taxon identifier). Additional specimen-based data include who identified the specimen, the basis of the ID, refined location (height, depth), microhabitat, associated specimen, etc. If no species name is readily assignable, some system of morphospecies designation should be adopted.

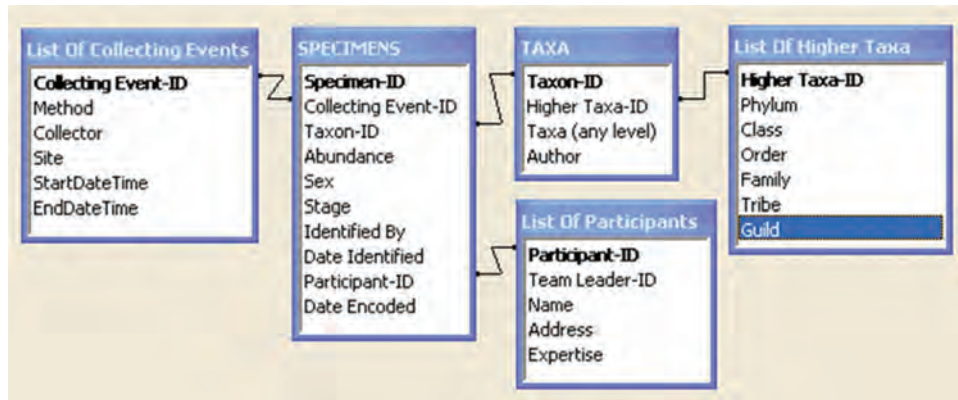

Fig. 4. Simplified structure of the five main tables constituting the core of a central database. Each table is equivalent to a spreadsheet. Fields (column headers) are listed in each box. Each record has a unique identifier (fields in bold ended by “-ID”) ensuring an unambiguous relationship with the other tables and avoiding information duplication. Tables are linked with “one to many” relationships symbolised by connecting lines (e.g. several specimens belonging to different taxa can be found during a single collecting event). Three tables, those starting with “List Of”, contain data common to all participants and which are used as entries for combo boxes. This allows all participants to use the same identifier for collecting events, participant names and higher taxa. Individual participants input data in the “Specimens” table and in the “Taxa” table. Other tables with additional information on study sites, environmental data, etc. can be added to the system.

It should be noted that the use of imposed codes for the whole project does not preclude the participants to use in parallel their own coding system. The database should be designed to handle participants’ own collector’s codes. Furthermore besides the standardized basic information about collecting events, taxa and specimens presented above, participants must be free to add in the centralized database additional information specifically relevant to their target taxa.

Even if the central database is web-accessible and can be downloaded, it is sometimes more practical for participants to encode the information in a local file saved on their own computer. Usually this is done by downloading a template under the form of a worksheet or database (preferably in an open source format). Once the data input is completed, participants can upload their file which is merged to the central database by the database administrator. To facilitate a wide dissemination of the biodiversity information, the central database can ultimately be provided to GBIF (Global Biodiversity Information Facility).

The database must also be GIS-interrelational and the use of a GPS device to georeference the observations in the field must be encouraged (see chapter 4). The mapping of environmental data and of other factors such as plot accessibility can be a very useful organizational and analysis tool. Plots can be selected along environmental gradients or to maximize the return of information per unit effort (White & Langdon, 2006). Maps of predicted species distribution can also be inferred from these data.

5.4.3. Labelling: standardization of data coding

Correct labelling of specimens is of prime importance. A label with a misspelled code or with unreadable information because its ink faded becomes unusable. If possible, it is recommended that good quality labels are printed for participants before field work starts and plan this item in the overall budget (see example at Fig. 5A). Labels with a unique identifier (e.g. an alphanumeric code) for each collecting event will serve as reference for the whole project. Participants carry a series of labels to the field and are encouraged to add to the sample another label with an alias identifier corresponding to their own coding system and with details on the collecting event (e.g. method, site, date, etc.).

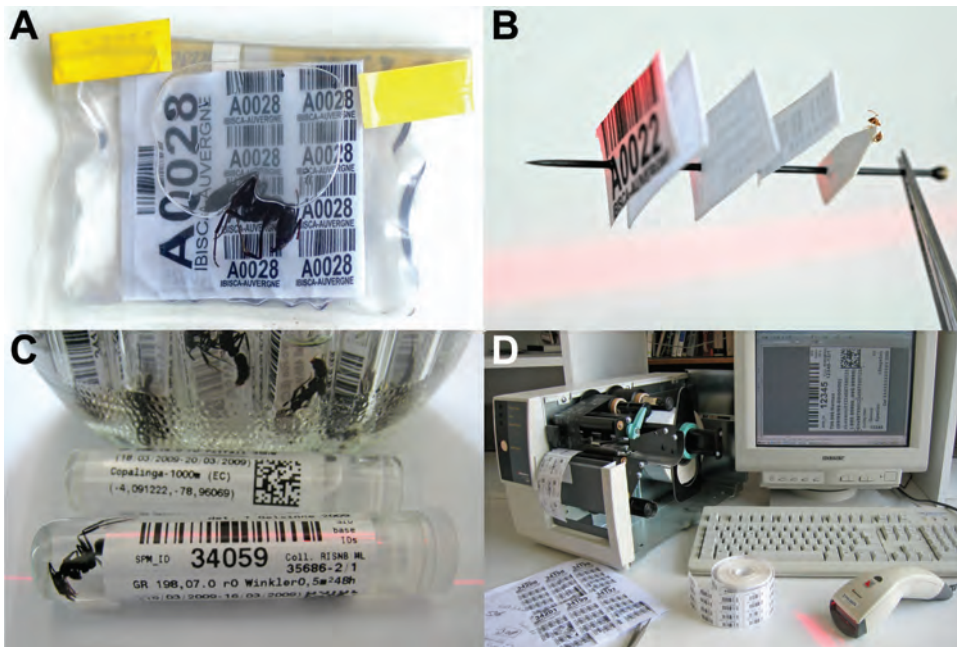

Fig. 5. Labelling of specimens with optical barcodes facilitates specimen management. A. Sampling bag (whirlpak) containing a series of identical labels. When sorting the sample it is then easy to add a label to each subsample stored in dry (B) or wet (C) condition. Two types of barcode are useable: unidimensional (stripes) or bidimensional (mosaic). D. A thermal label printer (on the left) is more costly than a regular laser printer but allows printing long-lasting labels required for long-term storage. Barcodes are generated by a specialized software. The barcode scanner (on the right) is connected in parallel to the computer keyboard. (Pictures by M. Leponce).

The addition of optical barcodes on the label speeds up the work of data encoding without errors (e.g. acquisition of sample, specimen or species codes). The barcode scanner is connected to the computer. No additional software is required since the scanner signal enters directly into the keyboard input. Unidimensional barcodes are the most commonly used, are generated by cheap or even free software and are readable with scanners costing around 250 €.

Bidimensional (2D) barcodes (dot matrices) allow storing a higher density of information but require a slightly more expensive scanner for reading them. Symbology code 128 has been used with success to generate small barcodes suitable for entomology (see Fig. 5B). Labels can be printed on 120 g paper with a laser printer but will peel off in alcohol over time. The ink of inkjet printers is often dissolved in the preservative. The best solution, but more expensive (several hundred to thousands Euros), is to use a thermal printer burning a special solvent-resistant ink on a thin sheet of polyester (Fig. 5C,D). The only disadvantage is that it is difficult to write on those polyester labels. Additional data (like sex, colour, length, etc.) is easier to write on archive paper with a pencil.

5.4.4. On-site management

Project coordinators assist and supervise the work of participants on site. They organize meetings with the participants and ensure that field data collection follows the general sampling protocol and is smoothly coordinated. Assistants dedicated to special techniques (DNA sampling, parasite collection, photography, etc.) accompany the collectors to the field. Managers are charged with planning all logistical aspects associated with the project (equipment, food, transport and accommodation of participants, base camps). Administrative constraints should be kept as light as possible to allow the participants to concentrate on their research.

5.4.5. Legal issues, collecting and export permits

Participants must respect all local regulations, decrees, laws and traditions. In particular they must ensure that they possess all the necessary permits for specimen collection and exportation. For some large projects such as the SANTO2006 expedition and the Moorea Biocode Project, collective, or umbrella permits are obtained. This implies that a single institution (e.g. a museum) or consortium may be responsible for all the material collected. These institutions may require that some or most material be deposited in their collections. In other cases each participant must ask a permit for its own material. The collections associated to the inventory are then spread among various institutions. Project coordinators should know the permitting and exportation rules and provide the required information to participants. Special attention should be given to the use of certain techniques or species. In particular, mass-collection is sometimes forbidden (e.g. rotenone stations, tree fogging), sensitive areas are often off-limits (e.g. small mountain peaks, popular dive sites), rare species are usually protected (endangered plants and animals), and the transportation of specimens in hazardous (flammable) fluids is regulated.

5.4.6. Security

Procedures in case of emergencies must be planned. General safety instructions should be given to project participants going out to the field (see for example Langdon & MacCulloch, 2004). If field operations are based from a research

station, all participants should be briefed by station staff about standard safety issues. Trained personnel (e.g. physician, nurse, etc.) should be available especially when conducting expeditions in remote areas, and an emergency plan should be submitted prior to operations that include the location of nearest hospital, decompression chamber, etc. Field participants should carry telecommunication equipment (e.g. mobile phone, walkie talkie, satellite phone, satellite beacon) and a first aid kit. A registry must be kept at the field base where participants indicate for each day their planned activity, location, estimated departure and return time. Such registry is also necessary to allow managers to organize the transportation and to provide the equipment and personnel (e.g. boats, climbing gears and tree climbers) needed by each research team. Trails and hazards (e.g. unapparent traps) should be well marked. Specific precautions associated with the handling of dangerous organisms or fixatives or with sampling in “extremes” habitats (e.g. caves) are described in the relevant chapters of this manual.

5.4.7. On-site processing and dispatching of material

Specimens captured with mass-collection methods have to be pre-processed as soon as possible, ideally on site (e.g. in a field research station). This work can be done by assistants supervised by senior taxonomists. During this process samples are divided in subsamples, based on taxonomic groups (Fig. 3), and are dispatched to taxonomic workgroup leaders in charge. Each leader defines who may be the appropriate taxonomist(s) for a finer identification, sends him the material and is responsible for the return of information to the central database. The number of specimens in each subsample is counted (or estimated roughly in the case of huge numbers) and encoded in the central database together with the name of the workgroup leader in charge. The same kind of information is also encoded for taxon-specific collection methods to keep a complete record of the material collected. When the database administrator receives datasets with identified specimens and merges them to the central database he must adjust the total numbers of identified and unidentified specimens per sample. If no experts are at hand for some taxonomic groups, the related specimens can be grouped as “residual material” and kept for later study or advertised on the clearing house web page (see above).

5.4.8. Incentives and follow-up

After the field work, progress reports are sent by workgroups to coordinators, and meetings are organized among workgroup leaders in order to follow a common agenda leading to several collective publications (e.g. book, special issue of a journal, publication in a high profile journal). Workshops are useful to review the overall progress of the inventory, address the concerns of stakeholders, define resource needs, promote consensus and reassess priorities and objectives. A substantial budget – at least the same amount than for field work – must be secured to stimulate the completion of the work.

5.4.9. Monitoring

Monitoring involves the repeated collection of long-term biodiversity data to evaluate changes in populations and environmental conditions. It can be used as an early warning system of changes in ecosystem functioning or to evaluate management actions. Monitoring targets certain taxa with the use of specific, non-intruding protocols. This activity is out of the scope of the present chapter and we refer the reader to more specialized references concerning that matter (*e.g.* Comiskey *et al.*, 1999; Yoccoz *et al.*, 2001; Schmeller, 2008; Nielsen *et al.*, 2009).

6. Conclusions

Large-scale species inventories and especially ATBIs are an effective way to increase our knowledge of the diversity of life on our planet. They are successful by creating synergies among the participants and allow an overall picture of complex ecosystems, something that would be impossible to obtain with smaller projects. In terms of science, long-term and representative biodiversity datasets are of great impact. Comprehensive inventories valorise the role of biological diversity in the functioning of ecosystems and the fundamental role of taxonomists. They are also instrumental for conservation and management decisions and contribute to raise public awareness about the need of conserving biodiversity. However the task is so huge that such endeavour requires careful planning. Resources to conduct ATBIs are limited, especially the taxonomic workforce itself. Lessons learned from the ongoing Smokies ATBI (Langdon *et al.*, 2006) show in particular that data management and data quality assurance are absolutely critical, funding must be secured to secure taxonomic assistance, bureaucratic burden must be reduced, over-collection of specimens must be avoided, the right person must be matched with the right position (organization of workgroups), participants must be well treated (infrastructure and logistics), and everyone must be involved in keeping costs down.

Biodiversity inventories can become never ending tasks. It is therefore important to keep the motivation of participants and of stakeholders by carefully planning the project output. The strategy must include pilot studies with fast deliverables in addition to long-term studies. A continuously updated website and database is probably a very good portal to show the results and dynamics of the project.

Taxonomic work (identifications, descriptions, revisions) usually takes time but preliminary results such as images of specimens or DNA sequences can be made publicly available quickly. Good visibility of the project is certainly also important to maintain the interest of the sponsors. New tools and approaches remain to be developed to increase the inventory efficiency. One could think of more automation in the tracking, documentation, storage and retrieval of specimens (*e.g.* increased use of standardized optical barcodes, semi-automated 3D image capture of specimens) or of new techniques to access environments difficult to reach (deep soil, canopy, etc.). The workforce should also be increased with the development of new taxonomic centres that could process efficiently all the material collected. The development of DNA barcoding and the

reduction of its cost will certainly open new opportunities to conduct inventories and monitoring. However, specimens or their body parts will always need to be collected in the first place and this represents the main bottleneck to appreciate the true dimensions of biodiversity on Earth (May, 2004). The accessibility of biodiversity data should be increased, following initiatives such as those of the Global Biodiversity Information Facility (GBIF), Encyclopedia of Life (EoL), Consortium for the Barcode of Life (CBOL), etc. Finally, the complementarity of ATBIs in terms of global biodiversity coverage and of scientific questions tackled should be increased by incorporating them into a global network. A move in this direction is done with the ATBI alliance which aims to expand the Smokies ATBI model to other protected areas in the U.S. and to provide the connectivity between local ATBI efforts (Langdon *et al.*, 2006; Hetrick *et al.*, 2007). The network of permanent plots of the Smithsonian Institution Global Earth Observatories aims at long-term monitoring of tropical and temperate forests. The network is in fast expansion and currently includes 34 sites in 20 countries. Collaboration with other global networks could be the next step for EDIT's ATBIs+M.

7. Acknowledgments

JD acknowledges his research grant by Conselho Nacional de Desenvolvimento Científico e Tecnológico (CNPq), Brasil. CPM acknowledges funding from the Gordon and Betty Moore Foundation and EDIT for participation in the ATBI+M workshop. Roger Le Guen, Panacoco, provided free use of his photos. Isabelle Bachy & Yves Laurent, RBINS, helped to edit the figures and text. We thank an anonymous referee for useful suggestions.

8. References

- ADIS, J., DA FONSECA, C.R.V & MARTIUS, C. 1998. Mecanismos que mantêm a diversidade tropical - um projeto de pesquisa bilateral teuto-brasileiro. *Acta Amazônica* 28: 205-215.
- ANDRE, H.M., DUCARME, X. & LEBRUN, P. 2002. Soil biodiversity : myth, reality or conning ? *Oikos* 96: 3-24.
- BASSET, Y. 1991. Leaf production of an overstorey rainforest tree and its effects on the temporal distribution of associated insect herbivores. *Oecologia* 88: 211-219.
- BASSET, Y. 2000. Insect herbivores foraging on seedlings in an unlogged rain forest in Guyana: spatial and temporal considerations. *Studies on Neotropical Fauna and Environment* 35: 115-129.
- BASSET, Y., NOVOTNY, V., MILLER, S.E. & PYLE, R. 2000. Quantifying biodiversity: experience with parataxonomists and digital photography in New Guinea and Guyana. *Bioscience* 50: 899-908.
- BASSET, Y., ABERLENC, H.-P., BARRIOS, H., CURLETTI, G., BERANGER, J.-M., VESCO, J.-P., CAUSSE, P., HAUG, A., HENNION, A.-S., LESOBRE, L., MARQUES, F. & O'MEARA, R. 2001. Stratification and diel activity of arthropods in a lowland rain

forest in Gabon. *Biological Journal of the Linnean Society* 72: 585-607.

BASSET, Y., NOVOTNY, V., MILLER, S.E. & KITCHING, R. 2003a. Arthropods of tropical forests. Spatio-temporal dynamics and resource use in the canopy. Cambridge University Press, xvi + 474 pp.

BASSET, Y., HORLYCK, V. & WRIGHT, S.J. (Eds) 2003b. *Studying Forest Canopies from Above: The International Canopy Crane Network*. Smithsonian Tropical Research Institute and UNEP, Panama City, 196 pp.

BASSET, Y., NOVOTNY, V., MILLER, S.E., WEIBLEN, G.D., MISSA, O. & STEWARD, A.J.A. 2004. Conservation and biological monitoring of tropical forests: the role of parataxonomists. *Journal of Applied Ecology* 41: 163-174.

BASSET, Y., CORBARA, B., BARRIOS, H., CUÉNOUD, PH., LEPONCE, M., ABERLENC, H.P., BAIL, J., BITO, D., BRIDLE, J.R., CASTAÑO-MENESES, G., CIZEK, L., CORNEJO, A., CURLETTI, G., DELABIE, J.H.C., DEJEAN, A., DIDHAM, R.K., DUFRÊNE, M., FAGAN, L.L., FLOREN, A., FRAME, D., HALLÉ, F., HARDY, O.J., HERNANDEZ, A., KITCHING, R.L., LEWINSOHN, T.M., LEWIS, O.T., MANUMBOR, M., MEDIANERO, E., MISSA, O., MITCHELL, A.M., MOGIA, M., NOVOTNY, V., ØDEGAARD, F., GAMA DE OLIVEIRA, E., ORIVEL, J., OZANNE, C.M.P., PASCAL, O., PINZÓN, S., RAPP, M., RIBEIRO, S.P., ROISIN, Y., ROSLIN, T., ROUBIK, D.W., SAMANIEGO, M., SCHMIDL, J., SØRENSEN, L.L., TISHECHKIN, A., VAN OSSELAER, C. & WINCHESTER, N.N. 2007. IBISCA-Panama, a large-scale study of arthropod beta-diversity and vertical stratification in a lowland rainforest: rationale, study sites and field protocols. *Bulletin de l'Institut Royal des Sciences Naturelles de Belgique, Entomologie* 77: 39-69.

BOUCHET, P., LE GUYADER, H. & PASCAL, O. 2009. The SANTO 2006 Global Biodiversity Survey: an attempt to reconcile the pace of taxonomy and conservation. *Zoosystema* 31: 401-406.

CHAO, A., COLWELL, R.K., LIN, C.W. & GOTELLI, N.J. 2009. Sufficient sampling for asymptotic minimum species richness estimators. *Ecology* 90: 1125-1133.

CHAZDON, R.L., COLWELL, R.K., DENSLow, J.S. & GUARIGUATA, M.R. 1998. Statistical methods for estimating species richness of woody regeneration in primary and secondary rain forests of NE Costa Rica. In Dallmeier, F. & Comiskey, J.A. (Eds). *Forest biodiversity research, monitoring and modeling: conceptual background & Old World case studies*. Parthenon Publishing, Paris: 285-309.

CHECK, E. 2006. Treasure island: pinning down a model ecosystem. *Nature* 439: 378-379.

COLWELL, R.K. 1994-present. EstimateS: statistical estimation of species richness and shared species from samples. [Persistent URL: <http://purl.oclc.org/estimates>.]

COLWELL, R.K. & CODDINGTON, J.A. 1994. Estimating terrestrial biodiversity through extrapolation. *Philosophical Transactions of the Royal Society of London, Series B* 345: 101-118.

- CODDINGTON, J.A., AGNARSSON, I., MILLER, J.A., KUNTNER, M. & HORMIGA, G. 2009. Undersampling bias: the null hypothesis for singleton species in tropical arthropod surveys. *Journal of Animal Ecology* 78: 573-584.
- COMISKEY, J.A., DALLMEIER, F. & ALONSO, A. 1999. Framework assessment and monitoring of biodiversity. *In: LEVIN, S. (Ed.) Encyclopedia of Biodiversity*. Princeton, NJ: 63-73.
- DELABIE, J.H.C., FISHER, B.L., MAJER, J.D., WRIGHT, I.W. 2000. Sampling effort and choice of methods. *In: AGOSTI, D.; MAJER, J. ALONSO, L.; SCHULTZ, T. (Eds). Ants. Standard methods for measuring and monitoring biodiversity*. Smithsonian Institution Press: 145-154.
- DELABIE, J.H.C., JAHYNY, B., DO NASCIMENTO, I.C., MARIANO, C.S.F., LACAU, S., CAMPIOLO, S., PHILPOTT, S.M. & LEPONCE, M. 2007. Contribution of cocoa plantations to the conservation of native ants (Insecta : Hymenoptera : Formicidae) with a special emphasis on the Atlantic Forest fauna of southern Bahia, Brazil. *Biodiversity and Conservation* 16: 2359-2384.
- DUCANE GODMAN, F. & SALVIN, O. (Eds) 1879-1915. *Biologia Centrali-Americana (Prospectus): Zoology, Botany and Archæology*. 63 vol. published R.H. Porter, London.
- GOTELLI, N.J. & COLWELL, R.K. 2001. Quantifying biodiversity: procedures and pitfalls in the measurement and comparison of species richness. *Ecology Letters* 4: 379-391.
- GÁMEZ, R., LOVEJOY, T., SOLORZANO & R., JANZEN, D. 1997. Costa Rican All-Taxa Survey. *Science* 277:18-19.
- GODFRAY, H.C.J. 2002. Challenges for taxonomy. *Nature* 417: 17-19.
- HAJIBABAEI, M., DEWAARD, J. R., IVANOVA, N.V., RATNASINGHAM, S., DOOH, R.T., KIRK, S.L., MACKIE, P.M. & HEBERT, P.D.N. 2005. Critical factors for assembling a high volume of DNA barcodes. *Philosophical Transactions of the Royal Society of London, Series B* 360: 1959-1967.
- HANBURY-TENISON, R. & JERMY, A.C. 1979. The RGS expedition to Gunung Mulu Sarawak. *Geographical Journal* 145: 175-191.
- HETRICK, S., KILLEFFER, T., & HILTEN, J. (Eds). 2007. *Biodiversity data interaction for an alliance of all taxa biodiversity inventories: a workshop to design methods, standards, and practices for data-sharing at the national level*. Proceedings of a Workshop. 04-05 December, 2006. Gatlinburg, Tennessee, USA. 44 pp.
- HILTEN, J., COX, J., DOURSON, D., GROSSNICKLE, H., PIERCE, J., SACHS, S., SUPER, P. & WETZEL, M. 2006. Science Education Programs with the ATBI. *The George Wright Forum* 23: 37-44.
- HOPKINS, G.W. & FRECKLETON, R.P. 2002. Declines in the numbers of amateur and professional taxonomists: implications for conservation. *Animal Conservation* 5: 245-249.
- IBOL BARCODING BIOTAS WORKING GROUP 2009. How to barcode biotas. A manual for planning. Biodiversity. Institute of Ontario, 40 pp.

- JANZEN, D.H. 1988. Guanacaste National Park: tropical ecological and biocultural restoration. In: *Rehabilitating damaged ecosystems*, vol. 11. Cairns, J., Jr. (Ed), CRC Press, Boca Raton, Florida: 143-192.
- JANZEN, D.H. & HALLWACHS, W. 1994. All Taxa Biodiversity Inventory (ATBI) of terrestrial systems: a generic protocol for preparing wildland biodiversity for non-damaging use. Report of a National Science Foundation Workshop, 16-18 April 1993, Philadelphia, Pennsylvania, USA, 141 p.
- JANZEN, D.H. 2004. Setting up tropical biodiversity for conservation through non-damaging use: participation by parataxonomists *Journal of Applied Ecology* 41: 181-187.
- JANZEN, D.H., HAJIBABAEI, M., BURNS, J., HALLWACHS, W., REMIGIO, E. & HEBERT, P. 2005. Wedding biodiversity inventory of a large and complex Lepidoptera fauna with DNA barcoding. *Philosophical Transactions of the Royal Society of London, Series B* 360: 1835-1845.
- JONES, D.T. & EGGLETON, P. 2000. Sampling termite assemblages in tropical forests: testing a rapid biodiversity assessment protocol. *Journal of Applied Ecology* 37: 191-203.
- KNIGHT, W.J. & HOLLOWAY, J.D. (Eds) 1990. *Insects and the rain forests of south east Asia (Wallacea)*. Royal Entomological Society of London, 343 pp.
- KRESS, W. J., WURDACK, K. J., ZIMMER, E. A., WEIGT, L. A. & JANZEN, D. H. 2005. Use of DNA barcodes to identify flowering plants. *Proceedings of the National Academy of Sciences* 102: 8369-8374.
- LANGDON, K. & MACCULLOCH, H. 2004. Backcountry Safety Guide. *Inventory and Monitoring Branch, Great Smoky Mountains National Park*. URL: http://www.dlia.org/atbi/science/guidelines_safety.shtml
- LANGDON, K., PARKER, C. & NICHOLS, B. 2006. Scientific findings, success stories, lessons learned, and an alliance of ATBIs. *The George Wright Forum* 23: 52-60.
- LAWTON, J.H., BIGNELL, D.E., BOLTON, B., BLOEMERS, G.F., EGGLETON, P., HAMMOND, P.M., HODDA, M., HOLT, R.D., LARSEN, T.B., MAWDSLEY, N.A., STORK, N.E., SRIVASTAVA, D.S & WATT, A.D. 1998. Biodiversity inventories, indicator taxa and effects of habitat modification in tropical forest. *Nature* 391: 72-76.
- LEATHER, S.R. 2009. Taxonomic chauvinism threatens the future of entomology. *The Biologist* 56: 10-13.
- LONGINO, J.T. & COLWELL, R.K. 1997. Biodiversity assessment using structured inventory: capturing the ant fauna of a tropical rainforest. *Ecological Applications* 7: 1263-1277.
- LONGINO, J.T. 2000. What to do with the data? In: Agosti, D., Majer, J., Alonso, L. & Schultz, T. (Eds). *Ants. Standard methods for measuring and monitoring biodiversity?* Smithsonian Institution Press: 186-203.
- LONGINO, J.T., CODDINGTON, J. & COLWELL, R.K. 2002. The ant fauna of a tropical rain forest: estimating species richness in three different ways. *Ecology* 83: 689-702.

- MAGNUSSON, W. E., LIMA, A. P., LUIZÃO, R., LUIZÃO, F., COSTA, F. R. C., VOLKMER DE CASTILHO, C. & KINUPP, V.F. 2005. RAPELD: a modification of the Gentry method for biodiversity surveys in long-term ecological research sites. *Biota Neotropica* 5: 1-6.
- MAY, R.M. 2004. Tomorrow's taxonomy: collecting new species in the field will remain the rate-limiting step. *Philosophical Transactions of the Royal Society of London, Series B* 359: 733-734.
- MILLER, S.E., KRESS, W.J. & SAMPER, C.K. 2004. Crisis for biodiversity collections. *Science* 303: 310.
- NICHOLS, B.J. & LANGDON, K.R. 2007. The Smokies All Taxa Biodiversity Inventory: History and progress. *Southeastern Naturalist*. Special Issue 1: 27-34.
- NIELSEN, S.E., HAUGHLAND, D.L., BAYNE, E. & SCHIECK, J. 2009. Capacity of large-scale, long-term biodiversity monitoring programmes to detect trends in species prevalence. *Biodiversity and Conservation* 18: 2961-2978
- NOVOTNY, V. & BASSET, Y. 2000. Rare species in communities of tropical insect herbivores: pondering the mystery of singletons. *Oikos* 89: 564-572.
- NOVOTNY, V., MILLER, S.E., HULCR, J., DREW, R.A.I., BASSET, Y., JANDA, M., SETLIFF, G.P., DARROW, K., STEWART, A.J.A, AUGA, J., ISUA, B., MOLEM, K., MANUMBOR, M., TAMI, E., MOGIA, M. & WEIBLEN, G.D. 2007. Low beta diversity of herbivorous insects in tropical forests. *Nature* 448: 692-695.
- PARKER, C. & BERNARD, E. 2006. The science approach to the Smokies ATBI. *The George Wright Forum* 23: 26-36.
- ROISIN, Y. & LEPONCE, M. 2004. Characterizing termite assemblages in fragmented forests: a test case in the Argentinian Chaco. *Austral Ecology* 29: 637-646.
- RONQUIST, F. & GÄRDENFORS, U. 2003. Taxonomy and biodiversity inventories: time to deliver. *Trends in Ecology and Evolution* 18: 269-270.
- SCHLICK-STEINER, B., STEINER, F.M., SEIFERT, B., STAUFFER, C., CHRISTIAN, E. & CROZIER, R.H. 2010. Integrative taxonomy: a multisource approach to exploring biodiversity. *Annual Review of Entomology* 55: 421-438.
- SCHMELLER, D.S. 2008. European species and habitat monitoring: where are we now? *Biodiversity and Conservation* 17: 3321-3326.
- SHARKEY, M.J. 2001. The All Taxa Biological Inventory of the Great Smoky Mountains National Park. *Florida Entomologist* 84: 556-564.
- SMALL A., ADEY A. & SPOON D. 1998. Are current estimates of coral reef biodiversity too low? The view through the window of a microcosm. *Atoll Research Bulletin* 458: 1-20.
- WALTHER, B.A. & MOORE, J.L. 2005. The concepts of bias, precision and accuracy, and their use in testing the performance of species richness estimators, with a literature review of estimator performance. *Ecography* 28: 815-829.

WHITE, P., MORSE, J., HARRIS, F., LANGDON, K., LOWE, R., NICHOLS, B., PARKER, C., PICKERING, J. & SHARKEY, M. 2000. The Science Plan for the All Taxa Biodiversity Inventory in Great Smoky Mountains National Park, North Carolina and Tennessee.

On-line at www.dlia.org/atbi/quarterly_newsletter/pdfs/science_plan.pdf.

WHITE, P. & LANGDON, K. 2006. The ATBI in the Smokies: an overview. *The George Wright Forum* 23: 18-25.

YOCCOZ, N.G., NICHOLS, J.D. & BOULINIER, T. 2001 Monitoring of biological diversity in space and time. *Trends in Ecology and Evolution* 16: 446-453.

9. Appendices

Appendix 1. New barcoders checklist

Some questions to which you should have specific answers before starting, and questions for iterative re-visiting as you go along.

General/Roles

- What organisms am I going to Barcode? What particular set of problems do these organisms present? Has anyone already done or actively is doing this? How many samples do I foresee collecting/processing?
- What do I already have and what do I need to do so?
- How much is this going to cost?
- Have I arranged for permits: collecting, export, import? Who is doing so if not me?
- Who (what person, institution or country) owns the intellectual rights to the specimens and to the information (barcode and collateral) associated with the project?
- Do you have the political/social/permit power to donate the specimens and/or their information to the recipient (GenBank, Guelph, Smithsonian or your museum, etc.)?
- What kind of condition will they be captured in, maintained in, transported in, vouchered in?
- Who are your points of contact for permits, vouchering, taxonomic identification, DNA extraction, extraction bio-banking, Polymerase Chain Reaction (PCR), DNA sequencing, data quality control (QC), data management, etc.?
- Who is primarily planning the project you are doing or contributing to?
- Which costs should I anticipate at various stages of the analytical process?
- Do I fully grasp the implications and differences between doing barcoding to simply build the overall/global barcode library, and doing barcoding for both

this purpose and species discovery (both in simply new species and in cryptic species)?

- What will I do when my sequencing lab runs out of funding in the middle of my project?
- Who is going to write the publication(s)? Who is going to co-author the work, in what order? Who is going to pay the reprint and page charges?

Vouchers/Taxonomy

- What collection/institution is going to receive my voucher specimens, what care will they get?
- Who is going to pay the bill for the storage/curation/subsequent identification and re-identification of my voucher specimens, why, when and for what reciprocal gain?
- How many vouchers per species is the receiver willing to take in, and just for barcode vouchers or also for exploratory biosystematics where warranted (e.g. 5-10 might be fine to establish a barcode library, but 100's may be necessary for exploring variation and cryptic species).
- Who is going to actually identify (first pass), re-identify (second pass), re-re-identify (n pass) my voucher specimens, and why should they care or bother (How am I going to compensate them)?

Metadata

- Who is collecting the metadata (GPS, photo, measurements, etc)? What metadata do I need to (minimum) or want to (optimally) collect?
- Do I have a digital camera and GPS unit? How do I keep the photos linked with the specimens?
- Who will receive and store and curate the images that are collateral data for the voucher specimens (and sometimes, the only voucher specimen that there is)?
- Do I understand to take high quality (though not necessarily beautiful) voucher specimen images that display the important identification traits (if possible) of the voucher specimen?
- Am I planning to have an individual metadata record in a standard database (DB) for every voucher specimen and collecting event? Is this DB website friendly and what website will house (and curate?) this DB, for what reason and with what caveats?
- Where will an electronic hard copy (frozen) version of this DB be deposited for long-term permanent storage, but at intervals replaced with an updated version (and who will do it)?
- Do I understand the difference between an event-based DB and a specimen-based DB?

Specimen collection and sub-sampling

- Who is actually collecting the specimens? Who is collecting the tissues for lab analysis?
- How are they collecting them? Where (if needed) are they getting the training, supplies, materials, kits and instructions to do so?
- What portion(s) of my animals am I going to take? Is this compatible with success in the lab and with subsequent morphological examination of the voucher? How do I remove my compatible tissues from the shell/skeleton/body part, etc.?
- What kind of container am I putting the tissue into? With what preservative? How am I transporting these back to the lab? How do I avoid cross-contamination?
- Where am I bio-banking the (leftover) tissues?
- Who is guiding/proving/fact-checking the field operations as they happen, and then by what mechanism will the barcoding results be fed back to the DB that contains the voucher collateral information, both to correct errors and to update the field identifications?

Laboratory

- Where/who is performing my DNA extractions? Are they archivable? Where will they be bio-banked?
- What protocol should I use for DNA extractions? Which sub-sampling procedure should I use to avoid cross-contamination? How much tissue do I need for DNA extraction? Do my organisms present any difficulties for DNA extractions? How do I do quality control (QC) for DNA extractions?
- Who is doing the PCR? Am I using Cytochrome Oxidase I (COI)? Does COI work for my organisms? What primers should I use? Are there any potential PCR obstacles from my organisms?
- How do I do QC for PCR? How do I check for contamination?
- Who is doing the DNA sequencing reactions? What do I need to provide them? How do I do QC on my DNA sequences? How do I know if my DNA sequences are good? Correct?
- How should I label my DNA sequencing reactions so that the chromatograms are easy to upload to BoLD/GenBank with my data?
- Who is going to, and WHY (and who pays his costs) manage the iterative process of my getting back neighbour joining (NJ) trees of sequences for my vouchers, studying them, and sending comments for corrections and elaborations back to the person/system that provided the NJ trees, and go

round and round with this? Who and why will then search for corroborative nuclear sequences when appropriate/warranted?

Data Handling

- How should I manage all my data? How and when do I submit specimen data to BoLD?
- What problems can I anticipate and avoid?
- When I discover errors or updates in my voucher specimen collateral information DB, how does this modification arrive at the target DBs such as GenBank, BoLD, etc.
- What do I do when a taxonomist out there disagrees with the name that I submitted for a barcode voucher, either at the species level or a higher taxon?
- Who owns which portions of your datastream from the field to GenBank or other final repository?
- What do I do if there is no taxonomist or taxonomic process willing to do the basic taxonomic process on my voucher specimens?
- Where do I turn for help?

Appendix 2. Some links and contacts

- CBOL: <http://www.barcoding.si.edu>
- BOLD: <http://www.barcodinglife.com>
- Some leading labs contacts: Lee Weigt (weigt@si.edu); Chris Meyer (meyerc@si.edu); Amy Driskell (driskella@si.edu); Robyn Cowan (r.cowan@rbgkew.org.uk); Natalia Ivanova (nivanova@uoguelph.ca); Mehrdad Hajibabaei (mhajibab@uoguelph.ca).

Chapter 4

Individual records and the associated data: information standards and protocols

by

Alexander Kroupa

European Distributed Institute of Taxonomy (EDIT),
Museum für Naturkunde - Leibniz Institute for Research on Evolution and
Biodiversity
Invalidenstr. 43, 10115 Berlin, Germany
Email: alexander.kroupa@mfn-berlin.de

David Remsen

Global Biodiversity Information Facility (GBIF)
Universitetsparken 15, 2100 Copenhagen, Denmark
Email: dremsen@gbif.org

Abstract

The structure of databases with taxonomic content is very important to ensure a compatibility with other database systems. For the exchange of taxonomic information it is necessary to have standards and protocols to permit the presentation, *e.g.* on a web system like GBIF, of species data from different database sources. For ATBI+M projects a guideline for recording species has been developed with the minimal requirements for a high data quality standard. Also standards are used, errors may occur along the information management chain from data recording up to data presentation. Error sources can be within the geo-referenced domain as well as in the taxonomic domain. Therefore software for automated geo-referencing and recording of date and time in standardized formats for mobile phones with GPS up to water resistant PDAs have to be developed. The gain of using those field tools is improving data quality and simplifying the data recording for a cost effective process to obtain high quality taxonomic information.

Key words: taxonomic database, standards, data quality, field tools, ATBI+M

1. Introduction

Taxonomic databases – databases that store information about biological entities: species and other taxa – have been developed to address curatorial management requirements, taxonomic and scientific needs, and more recently, for presentation of species data (distribution maps, pictures, biology etc.) to a wider public (Dalcin, 2005). These databases have the taxon as the principal entity, represented by its main identification: the taxon name. Taxonomic databases often have a focus on terminal taxa: species and infraspecies levels, which consist of a genus and species name, and when applicable, additional infra-species names. Data or Information is tied to the taxon and typically falls into two levels of organisation: either elements that relate to the taxon as a whole or elements that relate to specific instance of a taxon. The latter class of information is known as species occurrence, or primary occurrence data. Primary occurrence data include data elements that describe a taxon occurrence such as a date a species may have been collected or a location where it was observed. General species data, on the other hand, describe properties ascribe to the entire taxon such as a general morphological description, or a range map. In this chapter we will focus on databases for primary occurrence data.

Every day probably more than 100,000 scientific biological records (observations, collected specimens) are recorded (personal estimation). Many of these data are still not digitally recorded and the majority of these data are not recorded using standard protocols or proper referencing. The goal is that all recorded datasets should be properly referenced and that all individual field records must be accurately geo-referenced with an exact date or interval. Therefore more and more electronic tools and software have to be used to facilitate the recording of species data sets and to minimize the amount of errors.

This chapter provides a review of the important data structure elements of primary occurrence data with the inclusion of best practices and recommendations in their use.

2. Data structure

Species-occurrence data is used to include specimen label data attached to specimens or lots housed in museums and herbaria (or in Universities, NGOs, Amateurs associations etc.), observational data (e.g. birdwatchers) and environmental survey data (Chapman, 2005a). The term has occasionally been used interchangeably with the term “primary species data”. In general we speak about “geo-referenced data” – e.g. records with geographic references that tie them to a particular place in space – whether with a geo-referenced coordinate (e.g. latitude and longitude, UTM) or not (textual description of a locality, altitude, depth). Normally, the data are referred to as “point-based”, although line (transect data from environmental surveys, collections e.g. along a river), polygon (observations from within a defined area such as a national park) and grid data (observations or survey records from a regular grid) are also included. Usually the data are also tied to a taxonomic name, but unidentified collections

may also be included by referencing to a higher taxon group (e.g., “Unidentified Aves”).

For sampling species data it is necessary to record not only where (a geospatial location) the species were found, but also when (date and time), what (taxonomy), how (collecting method) and who collected/observed the specimen. Each locality (where) may have different events (Fig. 1), which means that sampling at more than one date or with different sampling methods have been carried out. Each event in turn may have its own species list or even more than one list if different researchers built their own lists for the same event.

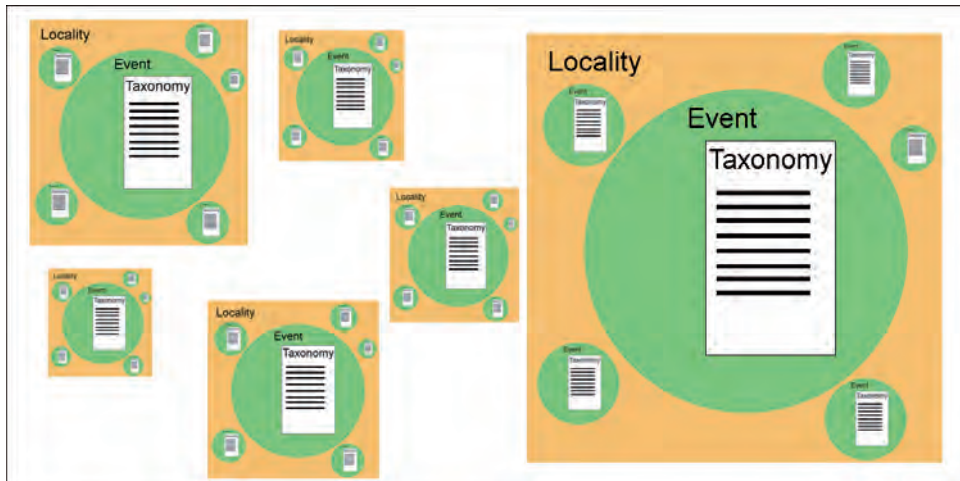

Fig. 1. Context of Locality, Event and Taxonomy by recorded species data.

2.1. Localities – where

Good locality descriptions lead to more accurate geo-references with smaller uncertainty values and provide users with much more accurate and high quality data. When recording data in the field, whether from a map or when using a GPS, it is important to record locality information as well as the geo-references, so that later validation can take place if necessary (Chapman & Wieczorek, 2006).

One purpose behind a specific locality description is to allow the validation of coordinates, in which errors are otherwise difficult to detect. The extent to which validation can occur depends on how well the locality description and its spatial counterpart describe the same place. The highest quality locality description is one with as few sources of uncertainty as possible. By describing a place in terms of a distance along a path, or by two orthogonal distances from a place, one removes uncertainty due to imprecise headings. Choosing a reference point with small extent reduces the uncertainty due to the size of the reference point, and by choosing a nearby reference point, one reduces the potential for error in measuring the offset distances.

To make it easy to validate a locality, use reference points that are easy to find on maps or in gazetteers. At all costs, avoid using vague terms such as “near” and “centre of” or providing only an offset without a distance such as “West of Albuquerque” (Table 1).

In any locality that contains a named place that can be confused with another named place of a different type, specify the feature type in parentheses following the feature name. Data without locality information or only with doubtful details should be flagged as not possible to geo-reference them with current information.

Vague Localities	BAD: Sacramento River Delta - an extremely large geographic area BETTER: Locke, Sacramento River Delta, Sacramento Co., California - names a town within the Delta
Names of Roads without additional points of reference	BAD: Highway 9, Alajuela Province, Costa Rica GOOD: Intersection of Hwy 9 and Rio Cariblanco, Cariblanco (town), Alajuela Province, Costa Rica
Localities difficult to Georeference	For many countries, especially Spanish-speaking ones, there are oftentimes several cities with the same name in the same province. BAD: San Marcos, Intibuca Province, Honduras - There are at least five San Marcos in Intibuca Province BETTER: San Marcos, ca 7.5 km south of Los Chaguities, Intibuca Province, Honduras

Table 1. Some examples for good and bad locality descriptions (from Museum of Vertebrate Zoology 2009a).

Guide for recording localities (Museum of Vertebrate Zoology 2009b)

- **Full Locality Name.** Provide a descriptive locality, even if you have geographic coordinates. Write the description from specific to general, including a specific locality, offset(s) from a reference point, and administrative units such as county, state, and country. The locality should be as specific, succinct, unambiguous, complete, and accurate as possible, leaving no room for uncertainty in interpretation. **Hint:** The most specific localities are those described by a) a distance and heading along a path from a nearby and well-defined intersection, or b) two cardinal offset distances from a single nearby feature of small extent.

- **Altitude (Elevation).** Supplement the locality description with elevation information. **Hint:** A barometric altimeter, when properly calibrated, is much more reliable than a GPS for obtaining accurate elevations.
- **Coordinates.** Whenever practical, provide the coordinates of the location where collecting actually occurred (see Radius, below). If reading coordinates from a map, use the same coordinate system as the map. **Hint:** Decimal degrees coordinates are preferred when reading coordinates from a GPS and if possible provide lat/long data.
- **Geographic Datum.** The datum is an essential part of a coordinate description; it provides the frame of the reference. When using both maps and GPS in the field, set the GPS datum to be the same as the map datum so that your GPS coordinates will match those on the map. **Hint:** Always record the datum with the coordinates.
- **GPS Accuracy.** Record the accuracy as reported by the GPS whenever you take coordinates. **Hint:** Most GPS devices do not record accuracy with the waypoint data, but provide it in the interface showing current satellite conditions.
- **Radius (Extent).** The extent is a measure of the size of the area within which collecting or observations occurred for a given locality – the distance from the point described by the locality and coordinates to the furthest point where collecting or observations occurred in that locality. **Hint:** A 1 km linear trap line for which the coordinates refer to the centre has an extent of 0.5 km.
- **References.** Record the sources of all measurements. Minimally, include map name, GPS model, and the source for elevation data.

For including geo-referenced records or observations into a database the **point-radius method** is commonly used (Wieczorek *et al.*, 2004). This method describes a locality as a coordinate pair (important: always include the geographic datum!) and a distance from that point (that is, a circle), the combination of which encompasses the full locality description and its associated uncertainties (GPS accuracy). The key advantage of this method is that the uncertainties can be readily combined into one attribute. With modern GPS devices the uncertainties are usually less than 10 m. To include historical data from natural history collections this method is also useable, when localities have typically been recorded as textual descriptions, without geographic coordinates. The calculation of the radius takes into account aspects of the precision and specificity of the locality description, as well as the map scale, datum, precision and accuracy of the sources used to determine coordinates.

2.2. Events – when

Guide for recording events

- **Start Date.** The date of the collection or observation should at least be recorded and if available the time as well. **Hint:** use a date format e.g. DD.MM.YYYY and a time format hh:mm:ss.

- **End Date.** For intervals (e.g. traps which are a longer period in the field) it is necessary to have a date for the end of the research. **Hint:** Use the end date also when the fieldwork takes only a couple of hours.
- **Collector(s).** Provide the name of each collector and when relevant the name of the expedition or research vessel (*i.e.* boat). **Hint:** Do not use abbreviations, write the full name, including second names or attributes like senior, junior to identify the collectors uniquely and avoid ambiguity of homonyms or families of collectors over several generations.

2.3. Taxonomy – what

Names, whether they are scientific binomials or common names, provide the first point of entry to most species and species-occurrence databases. The correct spelling of a scientific name is generally governed by one of the various Codes of Nomenclature (see list under Technical References). Errors can still occur, however, through typing errors, ambiguities in the Nomenclatural Code, etc. The easiest method to ensure such errors are kept to a minimum is to use an ‘Authority File’ during recording of data (Chapman, 2004a). An authority file is a pre-composed list of verified species names. Current lists of species names may be found at a number of places and some of these are listed in Chapman (2004b) (*e.g.* Species2000, FaunaEuropaea, 4D4Life). Also, the re-use of entered terms *via* internal controlled lists in an application that provides pull-down lists of previously entered terms can help maintain consistency when a controlled list is not available.

If it is not possible to use authority lists, a recommendation is than to process the collected information as quickly as possible after the fieldwork.

The structure of the database has to be clear, unambiguous and consistent. The taxon information should be atomized so that it is always clear that one field includes just the genus or the species name and is not mixed to have just one field with the genus and the species name together. One should always atomize the taxonomic information into separate Genus/Species/infraspecific Rank/Infraspecies/Author fields etc. wherever possible.

Guide for recording the minimum taxonomy for species-level taxa

- **Genus name.** The genus name is essential. **Hint:** Do not use any abbreviation.
- **Species name.** The species name is essential. **Hint:** Do not use any abbreviation.
- **Authors of a species name.** The author(s) name should be included to ensure a unique mapping in case of homonyms.
- **Determinator.** The name of the person(s) who is responsible for the determination of the collection/observation. **Hint:** Do not use any abbreviation, write the full name.

- **Taxon Source.** A reference to a taxonomic guide or treatment that forms the basis for the identification. Species are often lumped with or split from other taxa over the course of revisions. Ambiguity is reduced by providing a reference to particular taxonomic view that provides a specific sense or definition of the taxon as used by the identifier.
- **Number.** The number of the individuals observed or collected. **Hint:** Use only numbers and no text (not 2-3, 3ff, some, abundant etc.)
- **Deposit.** For further studies the deposit of collected material should be recorded. **Hint:** Abbreviations have to be well-defined, better do without abbreviations. Add the town of the museum, especially if it is not a well-known museum.
- **Family and other higher parent taxa.** The family or higher taxon that includes the referenced species. This information may be useful for providing taxonomic context in later references to the record.

3. Standards

Since more and more taxonomic databases are appearing, both institutional and individual concern about sharing data is rising. At this moment the need to establish data standards and communication protocols is obvious in order to make data sharing between different databases possible (Dalcin, 2005).

A number of recent collaborations within the museum community have resulted in establishing data standards. Examples include the Darwin Core Schema (Vieglais, 2003) along with the DiGIR protocol (SourceForge, 2004) and the combined BioCASE protocol (BioCASE 2003) and ABCD schema (TDWG, 2004) that are more fitted for interchange of primary species information. The Biodiversity Information Standards (TDWG) and others developed a new protocol (TAPIR - <http://www3.bgbm.org/tapir>) that supports multiple data formatting standards that is intended to provide a single solution for publishing data to the GBIF network. TAPIR can be implemented in multiple degrees of complexity and capacity (lite, medium, full) but importantly, still require advanced technical skills to install and maintain.

The newest and ratified Darwin Core terms provides a unified approach to publishing both species-level and species-occurrence-level data using a common standard. This "DarwinCore Archive" format is being championed by GBIF and while it is a supported output of the Integrated Publishing Toolkit, provides a simple enough data publication solution that it can be output as a direct database export by many data managers.

For recording geo-referenced species data a guideline with the most important fields for species occurrence data has been developed within the EDIT project (EDIT, 2009). This structure has been developed especially for recording data in the ATBI+M sites and is used by everyone sampling for ATBI purposes. It may also be used as a base for creating own databases.

4. Errors

4.1. Sources of error in data (Hellerstein, 2008)

- **Data entry errors.** It remains common in many settings for data entry to be done by humans, by keying in data from written or printed sources, e.g. after fieldwork. In these settings, data is often corrupted at entry time by typographic errors or misunderstanding of the data source (see 2.3).
- **Measurement errors.** In the measurement of physical properties, as altitude or spatial data, the increasing proliferation of sensor technology has led to exact measurements. Nevertheless data errors are still quite common: selection and placement of sensors often affects data quality, and by transferring data to the database errors may occur. Converting coordinates from one system to another may cause errors and converting longitude/latitude data from degrees to decimal may often result in a wrong calculation (Table 2).
- **Distillation errors.** In many settings, raw data are preprocessed and summarized before they are entered into a database. This data distillation is done for a variety of reasons and has the potential to produce errors in distilled data, or in the way that the distillation technique interacts with the final analysis.
- **Data integration errors.** Any procedure that integrates data from multiple sources can lead to errors. To minimize integration errors standards are necessary to ensure that fields contain the same entity type. That e.g. a species field contains only the species epithet and not genus and epithet together.

latitude / longitude	formula	calculation	decimal result
44° 16' 12,01" - 7° 23' 48,50"	degrees + (minutes / 60) + (seconds / 3600)	44 + (16 / 60) + (12,01 / 3600) / 7 + (23 / 60) + (48,50 / 3600)	44,27000278° - 7,39680556°
44° 15,368' - 7° 22,86'	degrees + (minutes / 60)	44 + (15,368 / 60) / 7 + (22,86 / 60)	44,2728° - 7,381°

Table 2. Two examples to show how to convert longitude/latitude data from degrees to decimal.

Names form the major key for accessing information in primary species databases. If the name is wrong, then access to the information by users will be difficult, if not impossible. Table 3 shows what may happen when entering names in a non-standard way. This is an extreme example but misspellings of names are the most frequent error in taxonomic databases.

<i>Actinobacillus actinomycetemcomitans</i>	<i>Actinobacillus actinomycetecomitans</i>	<i>Actinobacillus actinomycetum</i>
<i>Actinobacillus actimycetemcomitans</i>	<i>Actinobacillus actinomycetemcmmitans</i>	<i>Actinobacillus actinomycetemcomitans</i>
<i>Actinobacillus actinomycetemcomitans</i>	<i>Actinobacillus actinomycetemcomintans</i>	<i>Actinobacillus actinomyectomcomitans</i>
<i>Actinobacillus actinomicetemcomitans</i>	<i>Actinobacillus actinomycetemcomitance</i>	<i>Actinobacillus actinomyetemcomitans</i>
<i>Actinobacillus actinomy</i>	<i>Actinobacillus actinomycetemcomitans</i>	<i>Actinobacillus actinonmycetemcomitans</i>
<i>Actinobacillus actinomyce</i>	<i>Actinobacillus actinomycetemcomitans</i>	<i>Actinobacillus actionmycetemcomitans</i>
<i>Actinobacillus actinomycemcomitans</i>	<i>Actinobacillus actinomycetemcommitans</i>	<i>Actinobacillus actynomicetemcomitans</i>
<i>Actinobacillus actinomyceremcomitans</i>	<i>Actinobacillus actinomycetemcomitans</i>	<i>Actinobacillus antinomycetemcomitans</i>
<i>Actinobacillus actinomycetam</i>	<i>Actinobacillus actinomycetencomitans</i>	
<i>Actinobacillus actinomycetamcomitans</i>		

Table 3. Result of non-standard data entry for the valid species *Actinobacillus actinomycetemcomitans* (source: from Neil Sarkar, uBio Project).

4.1. Data cleaning

Chapman (2005a) shows that the cost of error correction increases as one progresses along the Information Management Chain (Fig. 2) and a manual process of data cleansing is also laborious, time consuming, and itself prone to errors (Maletic & Marcus, 2000). Tools have to be developed for data cleaning and preventing of errors at their point of origin is the most cost-effective method.

Tools are being developed to assist the process of adding geo-referencing information to databased collections. Such tools include eGaz (Shattuck, 1997), geoLoc (CRIA, 2004), BioGeomancer (Peabody Museum n.dat.), GEOLocate (Rios and Bart n.dat.) and the Georeferencing Calculator (Wieczorek, 2001).

The most important point is that correcting problems and adding sufficient annotation for use should be done prior to, not after, publication of the data. Data validation and annotation services should be done by the curator, not after the data has been published and copies transferred. When services are run against a copy of the data they need to be transferred and reconciled with the source copy, increasing complexity and risking the introduction of new errors. This approach will not apply to the many legacy datasets that are no longer curated so there will always be a need for the application of validation and annotation services as post-publication processes as well.

5. New technologies for data recording

It is necessary to develop tools for recording spatial and taxonomic data in the field for a number of reasons. In particular it is cost-effective to avoid mistakes right at the beginning of the recording chain (Fig. 2). Each error which is not made saves a lot of time. Errors may be avoided by using authority lists, e.g. for countries, habitat-types or species groups that can be determined to a great part in the field.

Automated geo-referencing and recording of date and time in standardized formats will also avoid typing errors by rewriting the data from paper to a database. The gain of using field tools is improving data quality and simplifying the data recording.

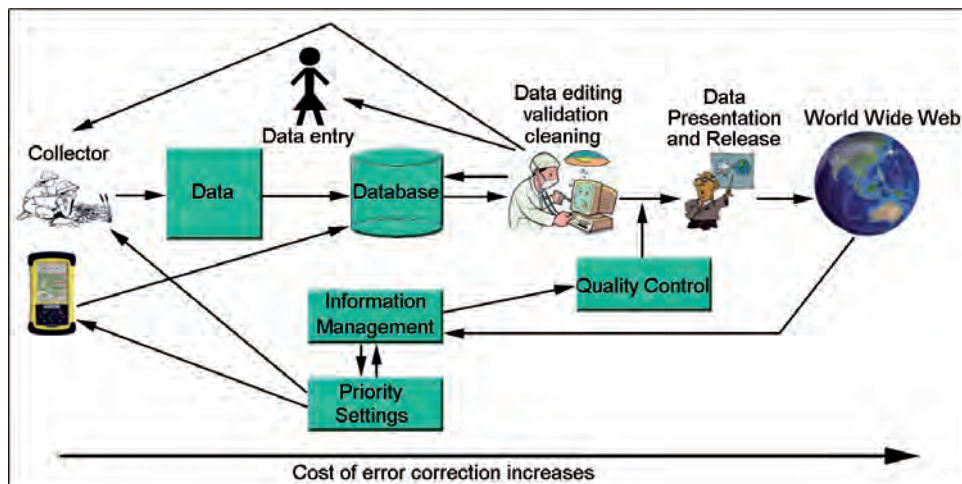

Fig. 2. Information Management Chain showing that the cost of error correction increases as one progresses along the chain (modified from Chapman, 2005a).

The developed software has to be usable for mobile phones with GPS up to water resistant PDAs (e.g. Magellan - Mobile Mapper; Trimble – Juno, Nomad).

For ArcPad (software from ESRI Inc.) some applications are already developed for recording data in the field for different types of use. One application is for birdwatchers and it focuses on birding sites near Gainesville (Wakchaure, 2006). Another application with customized ArcPad forms was developed for an earthworm inventory to be conducted during summer 2004 (Dabrowski, 2004). This study would measure the impact of European earthworm invasions on vegetation and soil characteristics at two Great Lakes national parks (Pictured Rocks National Lakeshore, located in the Upper Peninsula of Michigan, and Voyageurs National Park, located in northern Minnesota).

Another software for ecological data entry is Pocket eRelevé (<http://ereleve.codeplex.com/> [accessed 4 Dec. 2009]) designed for naturalists. This program is developed in Visual Basic and only available in French. For bird

watchers an application exists called Pocket Bird Recorder to record sightings in the field with mobile devices (<http://www.wildlife.co.uk> [accessed 4 Dec. 2009]).

5.1. ATBI+M approach (one example for an application with customized forms for ArcPad)

The example discussed in detail for electronic data recording in the field is the application for mobile recording with customized forms for ATBI+M sites. These forms are for mobile devices with the installed software ArcPad (a tool from ESRI Inc.). The system requirements are a Windows Mobile operating system, Microsoft Active Sync 4.5 for desktop synchronization and a Microsoft XML Parser. These forms are available at <http://www.atbi.eu>. The basis of this application is the programming of the Earthworm project with the customized ArcPad forms for selecting species, named Species Picker (Dabrowski, 2004).

5.1.1. Locality forms

For recording locality information, two customized forms exist. On the first form, (Fig. 3) a code and a name for the locality is arbitrary. The country can be selected from a list box and specifications to the macrohabitat and remarks can be made (see 2.1).

The screenshot shows a mobile application window titled "ATBI Locality". It has a navigation bar with "Locality", "Geo", and "E" buttons. The form contains several input fields: "Locality code" with the value "2009-07", "Locality name" with "Juniperus", "Country" with a dropdown menu showing "Germany", "Macrohabitat" with a text area containing "Juniper open scrub habitat on exposed rock face", and "Remarks" with a text area containing "30m S-N.". At the bottom left, there are "ok" and "cancel" buttons.

Fig. 3. Editform for Locality data. Locality code has to be unique.

The screenshot shows a mobile application window titled "ATBI Locality". It has a navigation bar with "Locality", "Geo", and "E" buttons. The form contains several input fields: "Latitude" and "Longitude" (empty), "Accuracy (m)" with "10", "Radius (m)" with "200", "Altitude (m)" with a range from "820" to "880" and "set Min" and "set Max" buttons, and "Coord. Sys." with a dropdown menu showing "WGS 1984". At the bottom left, there are "ok" and "cancel" buttons.

Fig. 4. Editform for the geo-referenced data. The values of latitude, longitude and altitude will be set automatically (if GPS is switched on). The values for the altitude range can be set also by pressing the button "set Min" respectively "set Max".

On the second form, (Fig. 4) information to the geo-referencing of the locality can be filled in. Latitude, longitude, accuracy and the minimum altitude are filled in automatically. The minimum and maximum altitude may be set with the two buttons “set Min” and “set Max” in the case the research area is not on one altitude level. But it is also possible to write values into these fields if other tools for measuring the altitude are used. Everybody has to bear in mind that the accuracy of the altitude measurement with GPS tools is very low. It is about 10 times lower than the accuracy for longitude or latitude.

The used coordinate system can be selected with a list box.

5.1.2. Event forms

For each locality more than one event can be created (see 2.2). Therefore a form exists to list all existing events for one locality (Fig. 5). The events are listed chronological with the start date of the events. Each event can be edited or deleted (deleting will delete also the attached species list).

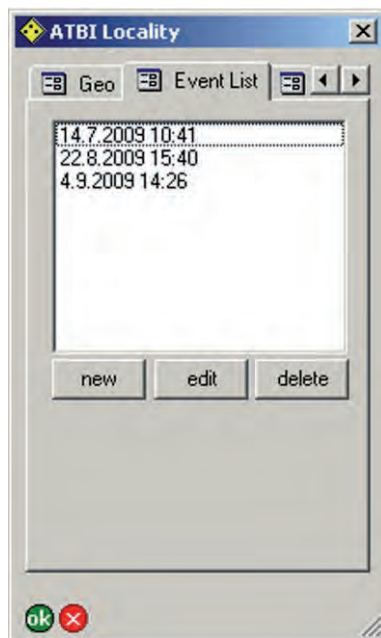

Fig. 5. List of all events belonging to one Locality ordered in chronological sequence.

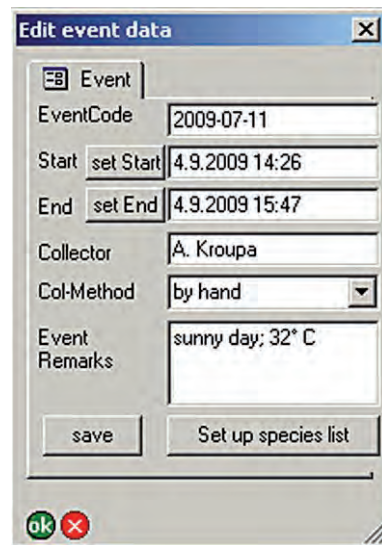

Fig. 6. Editform for one event. The value of the start time will be set automatically. The values for the start time and end time can be set also by pressing the button “set Start” respectively “set End”.

The detail data for each event consists of one EventCode and of the start and the end date (time) of this event (Fig. 6). The start date will be created automatically by creating a new event. The format for the date is [DD.MM.YYYY hh:mm:ss]. With the buttons “set Start” and “set End” the current time will be filled into the adequate fields. The collector, the collecting method and remarks can also be added to each event.

5.1.3. Species forms

For each event a species list of observed or collected specimens can be created. Therefore a species has to be selected on the page “All Species” (Fig. 7) from an authority species list (dbf-file). This file can be created by researchers themselves and can be exchanged easily for using different species groups (see 2.3 and 4.1). With the button “Add” the selected species will be transferred to the species list of this event. For each species the sex and the number of observed/collected specimens can be selected.

On the page “Event Species” (Fig. 8) all selected species are listed with information to the sex and the number of individuals. The records can be removed by selecting one entrance and pressing the button “Remove Selected”.

Wrong entries of numbers can be corrected by choosing on the Page “All Species” the species which has to be corrected with the correct number of individuals. After pressing the “Add” button the correction has to be confirmed and then the new number of individuals is saved.

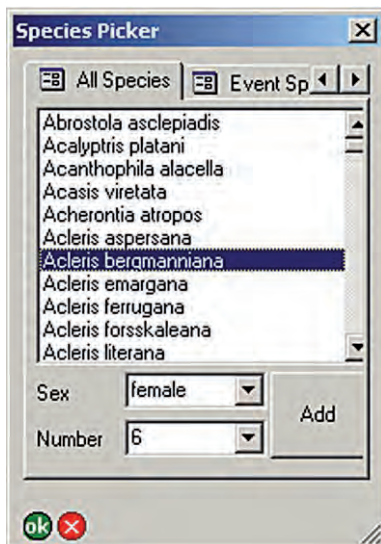

Fig. 7. List of all species that can be selected. For each species the sex and the number of individuals can be added.

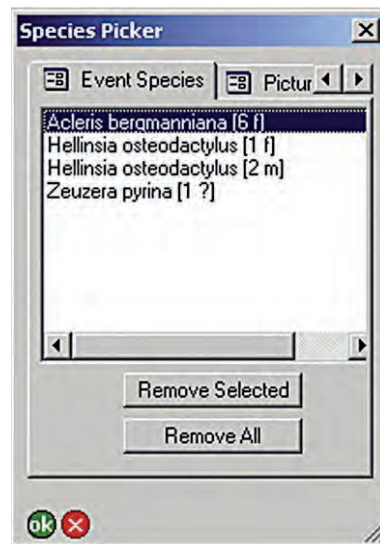

Fig. 8. List of species for one event. For each species the number of recorded specimens and their sex are available in brackets. (f female; m male; ? unknown).

5.2. From field to the web

The transfer of data from the field to the web environment via networks and portals such as BioCASE, GBIF or WDPA (<http://www.wdpa.org>) is necessary in order to provide global access to the sampled data (Fig. 9). All the records – observations, collected specimens or literature data – have to be transferred to an online database that provides access, for example through a “wrapper” for GBIF. A “wrapper” is a piece of software that maps data contained in a local database to a common data exchange standard and then serves these data through standard exchange protocols. This allows different databases to publish data to a network in a common form – enabling integration and the development of common tools.

To integrate biodiversity data from heterogeneous sources using common standards and protocols, GBIF developed the Integrated Publishing Toolkit. The GBIF IPT is an Open source Java based web application. It embeds its own database, is easily customisable and is multilingual. The data registered in a GBIF IPT instance is connected to the GBIF distributed network and made available for public consultation and use via established data access formats and protocols that include TAPIR and Open Geospatial Consortium (OGC) web mapping and web feature services (WMS and WFS) (Réveillon, 2009). Simple transformations of the DarwinCore Archive file would also support the creation of Keyhole Markup Language (KML) files for use within Google earth.



Fig. 9. Data flow from the field recording with GPS tools to different internet presentations.

6. Acknowledgements

We wish to thank A.D. Chapman and J. Wiczorek who, due to their publications, created a profound basis for this chapter.

7. Acronyms

ABCD	Access to Biological Collections Data
ATBI+M	All Taxa Biodiversity Inventory + Monitoring

BioCASE	Biological Collection Access Service
DiGIR	Distributed Generic Information Retrieval
GBIF	Global Biodiversity Information Facility
GPS	Global Positioning System
IPT	Integrated Publishing Toolkit
KML	Keyhole Markup Language
OGC	Open Geospatial Consortium
TAPIR	TDWG Access Protocol for Information Retrieval
TDWG	Taxonomic Databases Working Group
UTM	Universal Transverse Mercator
WDPA	World database on protected areas
WFS	web feature services
WMS	web mapping features

8. Key links

Access to Biological Collection Data (ABCD)

<http://wiki.tdwg.org/twiki/bin/view/ABCD/> [accessed 4 Oct. 2009] (TDWG Wiki for ABCD)

http://www.bgbm.org/tdwg/codata/schema/ABCD_2.06/HTML/ABCD_2.06.html (XSLT Schema) [accessed 4 Oct. 2009]

DIVA-GIS

<http://www.diva-gis.org> [accessed 4 Oct. 2009]

Environmental Resources Information Network (ERIN)

<http://www.deh.gov.au/erin/index.html> [accessed 4 Oct. 2009]

GEOLocate – University of Tulane

<http://www.museum.tulane.edu/geolocate/> [accessed 4 Oct. 2009]

Mammal Networked Information System (MaNIS)

<http://manisnet.org/> [accessed 4 Oct. 2009]

<http://manisnet.org/Documents.html> (MaNIS Documents) [accessed 4 Oct. 2009]

<http://manisnet.org/GeorefGuide.html> (Georeferencing Guidelines) [accessed 4 Oct. 2009]

Museum of Vertebrate Zoology Informatics (MVZ) – University of California, Berkeley

<http://mvz.berkeley.edu/Informatics.html> [accessed 4 Oct. 2009]

http://mvz.berkeley.edu/Locality_Field_Recording_Notebooks.html (Guide for Recording Localities in the Field) [accessed 4 Oct. 2009]

http://mvz.berkeley.edu/Locality_Field_Recording_examples.html (Examples of Good and Bad Localities) [accessed 4 Oct. 2009]

http://mvz.berkeley.edu/Locality_Field_Recording_important.html (Why it is Important to Take Good Locality Data) [accessed 4 Oct. 2009]

OGC Recommendations Document Pointer

<http://www.opengeospatial.org/standards/is> [accessed 4 Oct. 2009]

9. References

BIOCASE 2003. *Biological Collection Access Service for Europe*. [see <http://www.biocase.org> - accessed 4 Oct. 2009].

CHAPMAN, A.D. 2004a. Environmental Data Quality – b. Data Cleaning Tools. Appendix I to *Sistema de Informação Distribuído para Coleções Biológicas: A Integração do Species Analyst e SinBiota*. FAPESP/Biota process no. 2001/02175-5 March 2003 – March 2004. CRIA, Campinas, Brazil. 57 pp. [see http://splink.cria.org.br/docs/appendix_i.pdf - accessed 30 Sep. 2009].

CHAPMAN, A.D. 2004b. Guidelines on Biological Nomenclature. Brazil edition. Appendix J to *Sistema de Informação Distribuído para Coleções Biológicas: A Integração do Species Analyst e SinBiota*. FAPESP/Biota process no. 2001/02175-5 March 2003 – March 2004. CRIA, Campinas, Brazil. 11 pp. [see http://splink.cria.org.br/docs/appendix_j.pdf - accessed 30 Sep. 2009].

CHAPMAN, A.D. 2005a. *Principles of Data Quality, version 1.0*. Report for the Global Biodiversity Information Facility, Copenhagen.

CHAPMAN, A.D. 2005b. *Uses of Primary Species-Occurrence Data, version 1.0*. Report for the Global Biodiversity Information Facility, Copenhagen.

CHAPMAN, A.D. & WIECZOREK, J. (Eds) 2006. *Guide to Best Practices for Georeferencing*. Global Biodiversity Information Facility, Copenhagen. [see www.gbif.es/ficheros/Colombia/Georeferencing_Best_Practices.pdf - accessed 24 Jun. 2009].

CRIA 2004. *GeoLoc-CRIA*. Campinas: Centro de Referência em Informação Ambiental. [see <http://splink.cria.org.br/tools/> - accessed 4 Oct. 2009].

DABROWSKI, J. 2004. *Experiences developing a custom ArcPad solution for an Earthworm Inventory*. [see <http://science.nature.nps.gov/im/units/mwr/documents/APExperiences.pdf> - accessed 4. Oct. 2009].

DALCIN, E.C. 2005. *Data Quality Concepts and Techniques Applied to Taxonomic Databases*. University of Southampton – Faculty of Medicine, Health and Life Sciences, 266 pp.

EDIT 2009. *Data recording guidelines for ATBI+M pilot sites*. [see http://www.atbi.eu/wp7/files/common/Excel_sheet_for_locality_and_event_entry.xls - accessed 30 Sep. 2009].

- HELLERSTEIN, J.M. 2008. *Quantitative data cleaning for large databases*. White paper, United Nations Economic Commission for Europe. 42 pp. [see <http://db.cs.berkeley.edu/jmh/papers/cleaning-unece.pdf> - accessed 21 Sep. 2009].
- MALETIC, J.I. & MARCUS, A. 2000. *Data Cleansing: Beyond Integrity Analysis*. Division of Computer Science, Department of Mathematical Sciences, The University of Memphis, Memphis, 10 pp.
- MUSEUM OF VERTEBRATE ZOOLOGY 2009a. *Examples of Good and Bad Localities*. [see http://mvz.berkeley.edu/Locality_Field_Recording_examples.html - accessed 18 Sep. 2009]
- MUSEUM OF VERTEBRATE ZOOLOGY 2009b. *MVZ Guide for Recording Localities in Field Notes*. [see <http://mvz.berkeley.edu/FieldLocalities.doc> - accessed 18 Sep. 2009]
- PEABODY MUSEUM n.dat. *BioGeoMancer*. [see <http://www.biogeomancer.org> - accessed 4 Oct. 2009].
- RÉVEILLON, A. 2009. *The GBIF Integrated Publishing Toolkit User Manual, version 1.0*. Global Biodiversity Information Facility, Copenhagen. 37 pp. [see http://gbif-providertoolkit.googlecode.com/files/GBIF_IPT_User_Manual_1.0.pdf - accessed 3 Dec. 2009].
- RIOS, N.E. & BART, H.L.JR. n.dat. *GEOLocate. Georeferencing Software*. User's Manual. Belle Chasse, LA, USA: Tulane Museum of Natural History. [see http://www.museum.tulane.edu/geolocate/support/manual_ver2_0.pdf - accessed 4 Oct. 2009].
- SHATTUCK, S.O. 1997. eGaz, The Electronic Gazetteer. *ANIC News* 11: 9.
- SOURCEFORGE 2004. *Distributed Generic Information Retrieval (DiGIR)*. [see <http://digir.sourceforge.net/> - accessed 4 Oct. 2009].
- TDWG 2004. *ABCD Schema – Task Group on Access to Biological Collection Data*. [see <http://bgbm3.bgbm.fu-berlin.de/TDWG/CODATA/default.htm> - accessed 4 Oct. 2009].
- VIEGLAIS, D. 2003. *The Darwin Core. Revision 1.5*. Lawrence, KA: University of Kansas Natural History Museum and Biodiversity Research Center.
- WIECZOREK, J. 2001. *MaNIS/HerpNet/ORNIS Georeferencing Guidelines*. [see <http://manisnet.org/GeorefGuide.html> - accessed 30 Sept. 2009].
- WIECZOREK, J., GUO, Q. & HIJMANS, R.J. 2004. The point-radius method for georeferencing locality descriptions and calculating associated uncertainty. *Int. J. Geographical Information Science* 18(8): 745-767.
- WAKCHAURE, A. 2006. *An Application for Birdwatchers – Final Report*. [see http://ashwinimail.web.officelive.com/Documents/0_website_GPS_birding_app.pdf - accessed 4 Oct. 2009].

10. Technical References

FRANCKI, R.I.B., FAUQUET, C.M., KNUDSON, D.L. & BROWN, F. 1990. Classification and Nomenclature of Viruses. *Archives of Virology*, Suppl. 2: 1-445.

INTERNATIONAL CODE OF BOTANICAL NOMENCLATURE 2000. International Code of Botanical Nomenclature (St Louis Code). *Regnum Vegetabile* 138. Königstein: Koeltz Scientific Books [see <http://www.bgbm.fu-berlin.de/iapt/nomenclature/code/SaintLouis/0001ICSLContents.htm> - accessed 4 Oct. 2009].

INTERNATIONAL CODE OF ZOOLOGICAL NOMENCLATURE 2000. International code of zoological nomenclature adopted by the International Union of Biological Resources International Commission on Zoological Nomenclature. 4th edition. London: International Trust for Zoological Nomenclature. [see <http://www.iczn.org/iczn/index.jsp> - accessed 4 Oct. 2009].

SNEATH, P.H.A. (Ed.) 1992. International Code of Nomenclature of Bacteria, 1980 Revision. Washington: International Committee on Systematic Bacteriology (ICSB). [see <http://www.ncbi.nlm.nih.gov/bookshelf/br.fcgi?book=icnb> - accessed 4 Oct. 2009].

TREHANE, P., BRICKELL, C.D., BAUM, B.R., HETTERSCHIED, W.L.A., LESLIE, A.C., MCNEILL, J., SPONGBERG, S.A. & VRUGTMAN, F. 1995. International Code of Nomenclature for Cultivated Plants. Winbourne, UK: Quarterjack Publishing. [see <http://www.ishs.org/sci/icracpco.htm> - accessed 4 Oct. 2009].

Chapter 5

Bioacoustics approaches in biodiversity inventories

by

Martin K. Obrist

Swiss Federal Research Institute WSL, Biodiversity and Conservation Biology
Zürcherstrasse 111, CH-8903 Birmensdorf, Switzerland
Email: martin.obrist@wsl.ch

Gianni Pavan

Centro Interdisciplinare di Bioacustica e Ricerche Ambientali
Dipartimento di Biologia Animale, Università di Pavia
Via Taramelli 24, 27100 Pavia, Italy
Email: gianni.pavan@unipv.it

Jérôme Sueur

Muséum national d'Histoire naturelle, Département Systématique et Evolution
UMR 7205 CNRS OSEB, 45 rue Buffon, 75005 Paris, France
Email: sueur@mnhn.fr

Klaus Riede

Zoologisches Forschungsmuseum Alexander Koenig
Adenauerallee 160, 53113 Bonn, Germany
Email: k.riede.zfmk@uni-bonn.de

Diego Llusia

Fonoteca Zoológica, Museo Nacional de Ciencias Naturales (CSIC)
José Gutierrez Abascal 2, 28006 Madrid, Spain
Email: diego_llusia@yahoo.es

Rafael Márquez

Fonoteca Zoológica, Museo Nacional de Ciencias Naturales (CSIC)
José Gutierrez Abascal 2, 28006 Madrid, Spain
Email: rmarquez@mncn.csic.es

Abstract

Acoustic emissions of animals serve communicative purposes and most often contain species-specific and individual information exploitable to listeners, rendering bioacoustics predestined for biodiversity monitoring in visually inaccessible habitats. The physics of sound define the corner stones of this communicative framework, which is employed by animal groups from insects to mammals, of which examples of vocalisations are presented. Recording bioacoustic signals allows reproducible identification and documentation of species' occurrences, but it requires technical prerequisites and behavioural precautions that are summarized. The storing, visualizing and analysing of sound recordings is illustrated and major software tools are shortly outlined. Finally, different approaches to bioacoustic monitoring are described, tips for setting up an acoustic inventory are compiled and a key for procedural advancement and a checklist to successful recording are given. Extensive literature and reference to a collection of web resources (<http://www.bioacoustics.myspecies.info>) complete the text.

Key words: acoustic, communication, vocalisation, sound, echolocation, biodiversity monitoring, wildlife recording

1. Introduction

Classification of animals observed or collected for biological inventories predominantly relies on visual attributes. However, many animals generate acoustic signals for communication and orientation, which are predestined for eavesdropping on their presence and behaviour. Acoustic signals can be received over varying distances, allowing for unobtrusive detection and observation of their producers. Acoustic observations are well established for *e.g.* birds, insects, anurans, bats or whales. Depending on type of signals and taxonomic group, species identification, abundance estimation or behavioural assessment is possible. But physical properties of sound require certain precautions during recording, analysis as well as interpretation. We outline these prerequisites, describe types of bioacoustical signals for major taxonomic groups, and present a short review on state-of-the-art equipment and methods for bioacoustic recording and analyses. We sum up with a step-by-step key on how to proceed in bioacoustic inventories and research.

2. Physics of sound

Sound consists of oscillating pressure waves travelling at temperature-dependent speed through media like air (343 m/s at 20°C), water (1484 m/s at 20°C) or the ground (~5000 m/s depending on porosity). The number of cycles per second indicates sound frequency and is measured in Hertz (Hz). The frequency range of human hearing ranges approximately from 20 Hz to 20 kHz, and is anthropocentrically considered as 'audible sound'. But hearing ranges of most animals extend below or above this human hearing range. Signals below are termed infrasound and are not recordable with standard equipment. Infrasound waves travel long distances and are well documented for seismic or weather events, but they are also generated and perceived by elephants or whales for long distance communication. Signals above human hearing range are termed ultrasound and used mainly for echolocation by bats and dolphins.

Sound energy is usually not measured as peak pressure but as the square Root of the Mean of the Squared pressure (RMS), because this quantifies the energy over all waveforms in a signal. It is most sensible to indicate this RMS pressure not as N/m^2 but rather on a logarithmic scale, which better corresponds to increments of perceived sensation. Sound pressure is therefore indicated as the ratio of pressure P to a reference pressure P_0 on a logarithmic scale. The commonly used reference pressure P_0 is $2 \times 10^{-5} \text{ N/m}^2$ RMS or 20 $\mu\text{pascals}$ RMS. This corresponds to a sound intensity of $10^{-12} \text{ Watt/m}^2$ and is roughly equal to the lowest pressure humans can detect at 1000 Hz. The log of the ratio, termed Bel, is divided by 10 and expressed in decibel (dB), to achieve sensible numbers. Because intensity varies as the square of the pressure, levels referring to the above reference are expressed as 20 times the \log_{10} of the ratio of P/P_0 and expressed as dB, thus sound pressure level (dB) = $20 \log_{10} (P/P_0)$. The logarithmic scale facilitates calculations within the wide range of intensities in sensory physiology – while a 3 dB difference is just perceptible, it takes about 10 times the intensity to sound twice as loud. Sound intensity decreases with the

square of the distance due to spherical spreading loss. Thus, doubling of the distance leads to an intensity level drop to a quarter, or a change of -6 dB. Equally, sound pressure level drops by 6 dB when doubling the distance (Sengpiel, 2010). As dB measures in water refer to a reference pressure of 1µpascal, all measures in water are 26 dB higher than in air for an identical sound pressure.

Furthermore, sound attenuation additionally increases progressively with increasing frequency due to atmospheric absorption (Lawrence & Simmons 1982), basically limiting *e.g.* ultrasound echolocation of bats to short ranges (~5 to 50 m depending on signal characteristics). Ultrasound becomes more directional with increasing frequency, which can additionally influence perceived signal characteristics. Sounds carry through dense vegetation, over considerable distances, and in darkness, rendering acoustics a non-invasive and economic way to study *e.g.* marine mammals, hidden forest inhabitants or nocturnal animals.

Recording of sounds requires a microphone (or a hydrophone), transducing mechanical energy from sound pressure into electrical voltage. Different frequency ranges and media require appropriate microphones, particularly for ultrasound and underwater sound recording (see Technologies section).

3. Sound producing animals

Animals produce sounds for territorial defence, for group interactions, mate attraction and for orientation. Most vocalisations exhibit highly distinctive features, to be used in taxonomy and systematics, and thus biodiversity research. Several new species have been discovered by their distinct signals, *e.g.* secretive and nocturnal species or morphologically similar (cryptic) sibling species. Bioacoustic monitoring is widely applied for well-known taxonomic groups like birds and mammals, but its application is now extended into lesser-known, species-rich groups such as insects. In the following, major taxonomic groups hitherto studied by bioacousticians are briefly characterised:

3.1. Insects

Most research concentrated on the Cicadidae and Orthoptera (*e.g.* Diwakar *et al.*, 2007; Riede, 1997; Sueur, 2006), a fraction of insects that produce loud audible songs (Fig. 1 A-C). Many more insect groups produce ultrasounds or weak vibrational signals not perceptible to man. Using appropriate microphones and amplifiers, acoustic inventorying and monitoring could easily be extended to other target groups, communicating by vibration (*e.g.* treehoppers: Hemiptera: Membracidae; Cocroft & McNett, 2006) or underwater stridulation, as documented for water bugs (Jansson, 1973). Sounds of insects are species-specific and stereotyped, but recognition of species-specific features requires visualisation. The temporal structure of their songs varies with temperature, further aggravating the recognition of insect species in the field.

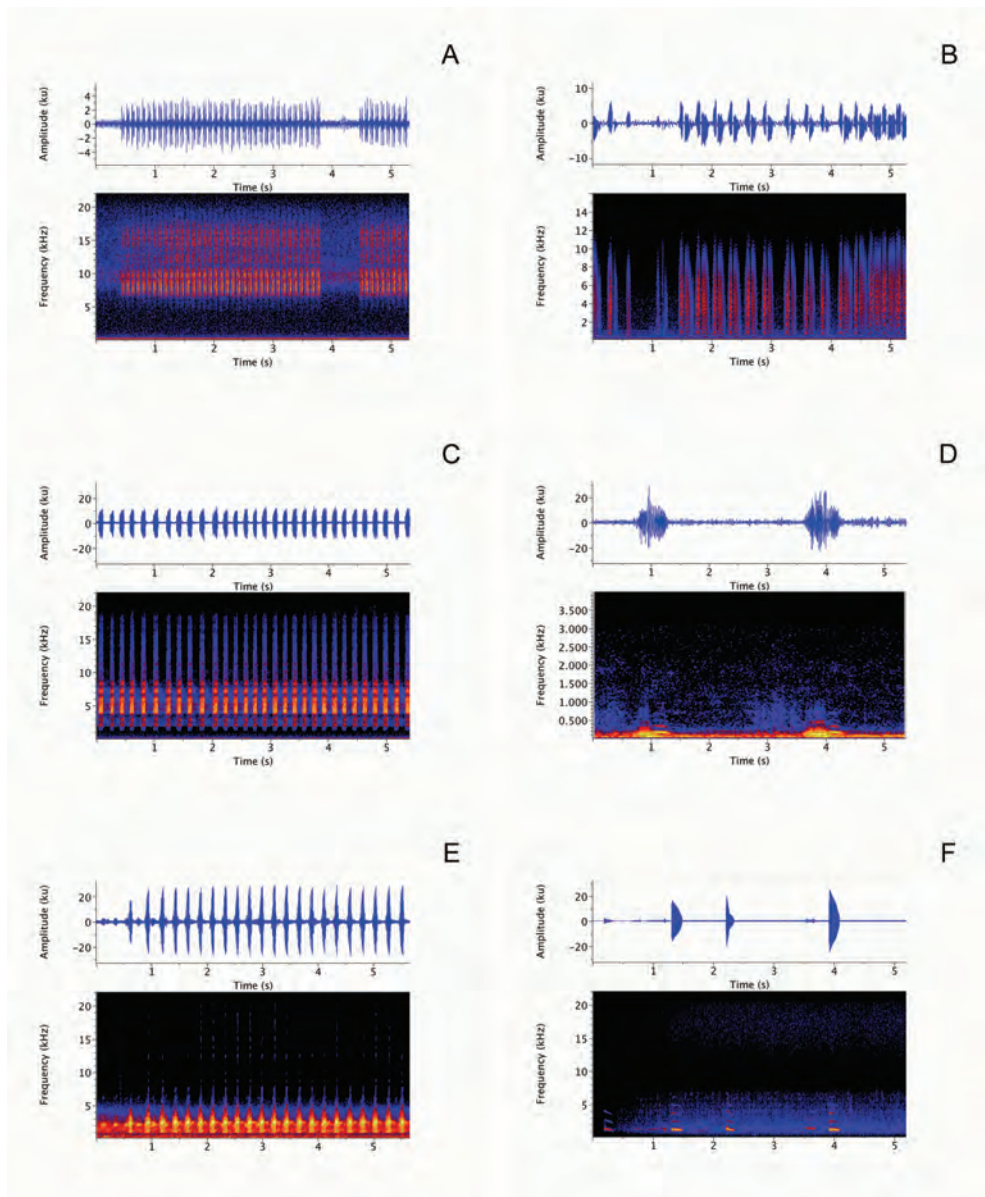

Fig. 1. Amplitude and spectrographic displays of acoustic signals of insects, fish, and anurans. A. Great Green Bush Cricket (*Tettigonia viridissima*); B. Scarabaeid Beetle (*Coprins incertus*); C. Mediterranean Cicada (*Cicada orni*); D. Italian Freshwater Goby (*Padogobius martensi*); E. European Tree Frog (*Hyla arborea*); F. Common Midwife Toad (*Alytes obstetricans*). Note the different frequency scales and dB ranges not comparable between subplots! Spectrograms were generated from recordings of the authors except A taken from data recorded at 18°C, available from <http://www.biologie.uni-ulm.de/cgi-bin/soundobj.pl?id=32797&lang=e&sid=T> (Digital Orthoptera Specimen Access DORSA archives – <http://www.dorsa.de>).

Acoustic signals used in mate finding have the potential for speciation effects, and enable bioacousticians to find new species. Particularly in insects, striking differences in song structure of morphologically similar species helped taxonomists to diagnose and describe 'cryptic species', many of which cannot be differentiated without a sound recording. Walker (1964) reviewed studies on songs and taxonomy of North American Orthoptera. He found that most morphologically defined species consisted of complexes of cryptic species. He estimated that one-fourth of the gryllid and tettigoniid species of the eastern USA had never been recognized or had been wrongly synonymized (Walker, 1964: 346). In Europe, acoustic analyses led to the discovery of new and important information about the biogeography of *Cicadetta* species (Sueur & Puissant, 2007).

3.2. Fish

Sound production in fish is poorly studied, although common: more than 50 Teleost families include sound producing species (Fig. 1D). Fish produce sounds during the breeding season, and their behaviour can be monitored with hydrophones (Ladich *et al.*, 1992; Torricelli *et al.*, 1990). Their sounds are of low frequency and intensity. Only in large aggregations can their sounds be monitored over larger distances.

3.3. Frogs, toads (anurans) and reptiles

Advertisement calls vary much less in anurans (Fig. 1E, F) than *e.g.* in birds (Gerhardt & Huber, 2002), which alleviates automated detection and species assignment of anuran calls (Brandes *et al.*, 2006). In reptiles, crocodylians utter a variety of communication sounds (Vergne *et al.*, 2009) and gekkos too have evolved a vocal repertoire from simple chirps to complex sequences they all use in social behaviour (Brillet & Paillette, 1991; Marcellini, 1974). However, signal characteristics in ectotherms change with ambient temperature (Kuhn & Schneider, 1984; Márquez & Bosch, 1995). This requires recording of soil, water, and air temperature (and relative humidity) for every sound file (Márquez *et al.*, 2008).

3.4. Birds

Birds are acoustically most conspicuous and are regularly being monitored acoustically especially in habitats with low visibility (*e.g.* Bart, 2005; Frommolt *et al.*, 2008b; Haselmayer & Quinn, 2000). The comparatively high song variability (Fig. 2A) within and between individuals makes species identification challenging for observers, and even more so for automated systems (Bardeli *et al.* 2008, Tanttú & Turunen, 2008). Birds such as the nightingale can hold vast and changing song repertoires (Todt & Hultsch, 1996). Nocturnal monitoring of birds along migratory routes, with arrays of directional microphones aimed at the sky (*e.g.* Dierschke, 1989; Evans & Mellinger, 1999; Graber, 1968; Schrama *et al.*, 2008) allows for the challenge of the identification of flight calls, the best possible tool to study such migrations.

In some cases, vocalizations do not only carry information at the species and the geographic, but also the individual level, which allows individual recognition of calling animals (Galeotti & Pavan, 1991; Laiolo *et al.*, 2007).

The use of playbacks to elicit responses of secretive birds has also been developed as a valid census technique (Conway & Gibbs, 2005; McGregor, 1992). Especially in North America, there are several large-scale bird monitoring schemes running (see review in Bart, 2005).

3.5. Terrestrial Mammals

Many mammals extensively use acoustic communication. Individual learning, experience and social contexts condition the development of communication and determine the vocal expression, which overall becomes much more variable than in taxa which show simpler behaviour (Vannoni & McElligott, 2007). But simpler vocalisations like breeding sounds can be monitored to map their presence. Red Deer (*Cervus elaphus*) calls (Fig. 2B) have been extensively recorded eventually resulting in population estimates (Favaretto *et al.*, 2006). Similar studies are made with wolves (*Canis lupus lupus*) by using recordings of their natural call and playback stimulations (Fuller & Sampson, 1988; Gaines *et al.*, 1995; Wilson & Delahay, 2001).

3.6. Bats

Bats do orient, navigate to food sources and roosts, and hunt for prey at night with ultrasound (Fig. 2C). Their mode of orientation was termed 'echolocation' by Griffin (1958). It allows to study bat distribution and behaviour, and has potential for species identification (Ahlén, 1981; Fenton & Bell, 1981). However, this is severely complicated, as sonar calls serve an auto-communicative function and only have limited species or individual specificity. Nevertheless, different technologies are available to monitor and record the inaudible ultrasound (Parsons & Obrist, 2004) (see Technologies section) and recently promising approaches to automated recognition emerge (Jennings *et al.*, 2008, Obrist *et al.*, 2008; Parsons & Jones, 2000; Russo & Jones, 2002; Skowronski & Harris, 2006).

3.7. Marine mammals

The high speed of sound (~1484 m/sec, varying with temperature and depth) and the low attenuation in water favour acoustic orientation and communication in the aquatic environment. As sight is often limited to a few meters distance in water and cannot be used in dark oceanic depths, acoustic communication is the dominant channel of communication in cetaceans. Their signals range spectrally from the very low frequencies of the large baleen whales to the ultrasonic clicks of the echolocating dolphins (Figs. 2 D-F). Their ultrashort biosonar signals (30 to 300 μ sec) reach peak source levels of 230 dB re 1 μ Pa/1m and range from 70 kHz to more than 150 kHz (Johnson *et al.* 2004), while social communication usually happens at lower frequencies but still impressive intensities. The distance of whale detection varies widely, depending on signal characteristics and

environmental constraints as well as background noise, most of which is caused by man. But during their deep dives up to one hour long, sound is the most efficient way to verify their presence at distances of kilometres. Species with known sounds can be mapped and their movement and behaviour tracked. Techniques to detect and record marine mammals are presented in the Technologies section.

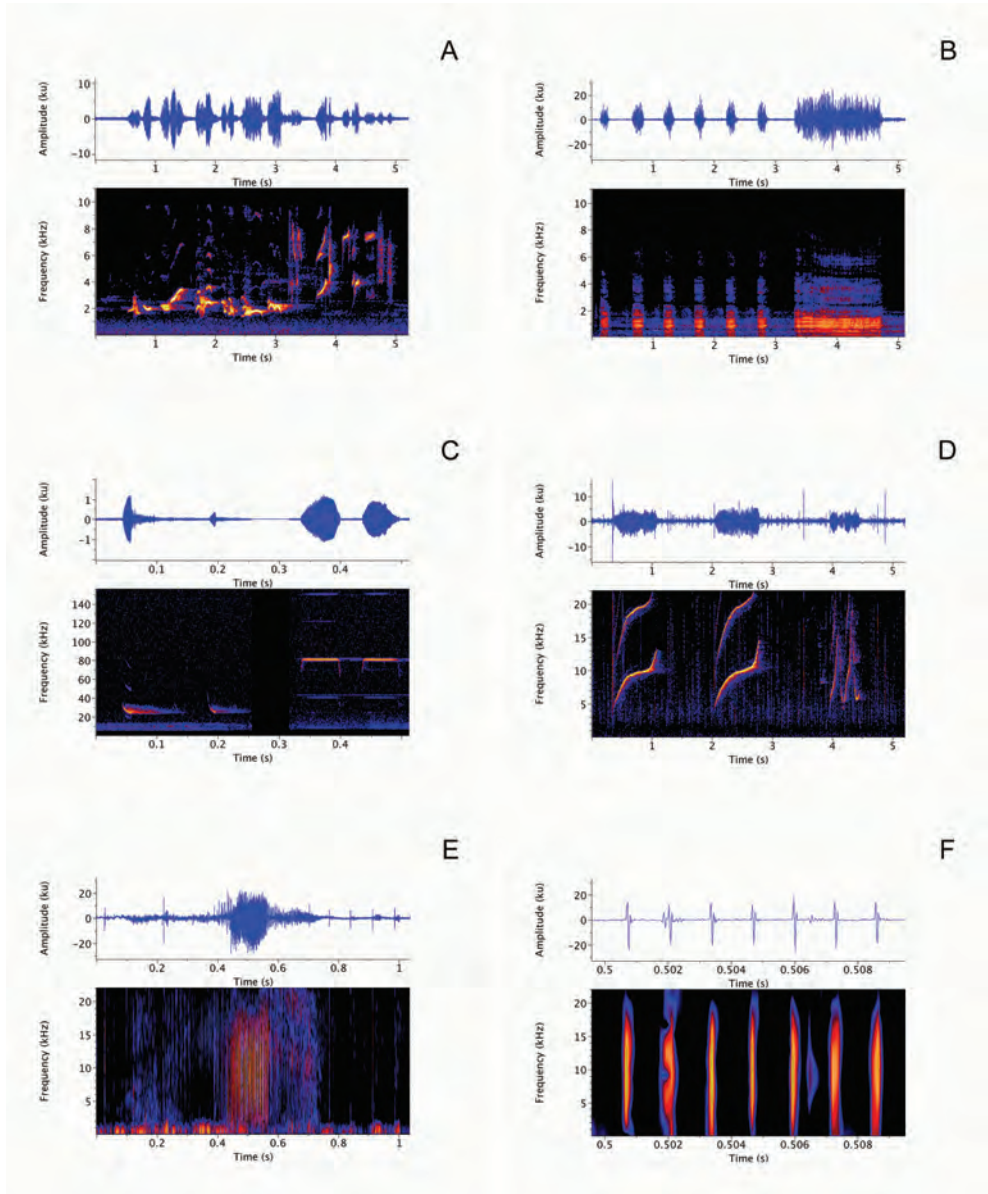

4. Technologies

Apart from a keen human ear, a typical equipment to study animal sounds starts with a microphone (or hydrophone) and a recording device. Progressively more specialized material like directional microphones or parabolas may come into use. For ultrasound generated by many insects, bats and marine mammals, 'bat detectors' and specialized equipment for the recording of ultrasounds are needed. Finally, recordings require hard- and software for replay, visualisation, and analysis of the signals. The following section tracks the technical workflow in bioacoustics research: sound pick-up, recording, storing, and analysis.

4.1. Microphones

Microphones contain a mechanically transducing element whose vibrations truthfully convert sound waves into an electrical signal. Different kinds of transducers all generate electrical signal, using electrodynamic, piezoelectric or capacitance and electrostatic effects. The electric representation of the acoustic signal can then be amplified, recorded, visualized, and further analysed or converted back to sound.

In *dynamic microphones*, an electromechanical element generates a current by electromagnetic induction when moved. Such microphones are robust, reliable and do not require external powering, but they have limited sensitivity, making them most useful in loud environments or at close range.

Piezoelectric transducers generate a voltage when stimulated by sound waves. They are used in Hydrophones (see below) and as contact microphones in musical instruments. These devices, historically used e.g. in low-cost bat detectors, are very sensitive at their resonant frequency but have variable response at other frequencies (Pye, 1992). To alleviate this, some bat detectors use two different transducers (e.g. BatBox III, Stag Electronics, Steyning, UK). A variable response remains and most detectors using these transducers offer only a limited signal output (Heterodyne; see <http://www.bioacoustics.myspecies.info>) making them unsuitable for spectral analysis. But ruggedness and price make them practical for some type of fieldwork.

Capacitance or *condenser microphones* are more generally suited and most widespread (Pye, 1993). Movement of the diaphragm in the microphone changes capacitance in the pre-charged condenser. Capacitance change is converted to voltage. Two primary types exist: Solid-dielectric and electret microphones.

Fig. 2 (opposite page). Amplitude and spectrographic displays of acoustic signals of birds, and mammals. A. Song of a Blackbird (*Turdus merula*); B. Call of a Red Deer (*Cervus elaphus*); C. Echolocation calls of bats; (left) from a Serotine Bat (*Eptesicus serotinus*), and (right) from a Greater Horseshoe Bat (*Rhinolophus ferrumequinum*); D. Whistle of a Bottlenose Dolphin (*Tursiops truncatus*); E. Buzz of *T. truncatus* in the audible range; F. Series of clicks in a buzz of *T. truncatus*. Note the vastly different time and frequency scales and dB ranges not comparable between subplots! Spectrograms were generated from recordings of the authors.

Solid-dielectric microphones have to be powered, e.g. with voltage supplied from the plug (PIP - Power In Plug in consumer products), over the signal cables (e.g. 48V phantom powering in professional recorders) or by an internal battery. Such microphones have quite a flat frequency response. They require higher supply-voltages to and are used as laboratory microphones and advanced bat detectors (see <http://www.bioacoustics.myspecies.info>). Their membranes are mechanically delicate and sensitive to changes in humidity, which can introduce noise into recordings, particularly in humid environments.

In contrast, diaphragms of *electret microphones* are electrically pre-charged, allowing for low power requirements in operation. They are relatively cheap, rugged, very small, and omni-directionally sensitive. Recent products are sensitive up to high ultrasound frequencies. The most recently developed Micro-Electrical-Mechanical System (MEMS) microphones have their pressure-sensitive diaphragm etched directly into a silicon chip with similar fabrication technologies used to make semiconductor devices

In *hydrophones*, the membrane is replaced by a piezoelectric element that produces an electric current when compressed by sound waves propagating under water. Single transducer hydrophones are omni-directional and typically cover a wide range of frequencies, from a few Hz to more than 100 kHz. In the marine environment, more complex array systems are often used to increase directionality and sensitivity. Hydrophones, or arrays of such, are either used in stationary setups to monitor selected areas, or slowly towed over larger regions. Autonomous systems pack hydrophones, amplifiers and a radio transmitter into a floating buoy (sonobuoy) and transmit data to a remote receiver. Packaged with a recorder in a pressure resistant container and deployed on the sea bottom to be retrieved later, underwater sounds can be recorded for a predetermined period. Appropriately sized, such packages can even be attached with suction caps (D-TAG) to an animal, to study its sounds concurrently with its diving profile (speed, depth, orientation), and the sounds it receives (Johnson & Tyack, 2003).

Directional microphones emphasize sounds coming from one direction and a single source, such as an individual singing bird, attenuating ambient sounds. A similar effect can be achieved by parabolas, which reflect sound waves coming from frontal, on-axis directions onto an omni-directional microphone positioned at their focus point. Gain and directionality increase with the ratio of the parabola's diameter to the sound's wavelength. Significant directionality is achieved only for wavelengths shorter than the diameter of the parabola (e.g. above 560 Hz with 60 cm Ø). Ultra-directional microphones (*shotgun microphones*) usually are cardioid condenser microphones fitted in a tube, which cancels off-axis signals. These microphones have a flat frequency response, but they are generally less sensitive than parabolic microphones, but rather resistant to wind and handling noise.

Pairs of microphones can be combined to produce *stereophonic recordings*, originally developed to transmit an impression of the spatial arrangement of sound sources. Such recordings can also be processed to emphasize certain sound sources, using software tools for 'source separation'. Stereophonic recording is mostly used to record 'soundscapes', but can also be used for

biodiversity monitoring as they convey information on the position of sound sources.

4.2. Digital recording

Quality

In the following description, we refer to recorder devices storing sound files in .wav format initially developed by Microsoft but now in use across all operating platforms (Rumsey & McCormick, 2006). We will not consider consumer electronic products allowing sound recording, such as Camcorders and cell phones. These products use a compressed format for storage (such as mp3 – see Rumsey & McCormick, 2006) that dramatically affects the spectral and temporal composition of the signal. This format is therefore inappropriate for detailed bioacoustic studies even if it could be used for some survey or monitoring work. Appropriate digital recorders reproduce signals with great accuracy, low noise, flat frequency response, and no speed variation. All digital recording devices sample sound with an analogue to digital (A/D)-converter and store the numeric values but not the actual voltage of the signal, on the device. Their usable frequency range is defined by half the sampling rate and the bit depth of the converter, roughly 6 dB per bit, defines the dynamic range. Thus, a 16-bit 44.1 kHz A/D-converter resolves 22.05 kHz with dynamics of 96 dB. High quality digital recording devices should then have an A/D-rate at least twice the highest frequency to be recorded and provide a digital output for lossless transfer.

Recorders

Digital music players and recorders nowadays have become devices of choice to record sound, including slowed down ultrasound. Some models can sample at up to 192 kHz, and some record on up to four channels (see below for ultrasound recording). Most are lightweight and inexpensive, feature large storage capacities and record at high fidelity, if compression algorithms can be switched off. Data are stored on an internal hard disk or on digital CompactFlash (CF), Secure Digital (SD) or SD High Capacity (SDHC) memory cards, all similar to random access memory (RAM) in computers, but with much higher portability.

Recording directly to computer hard disk is well established since the 1980s. Data acquisition boards easily allow for sample rates up to several MHz, enabling direct recording of ultrasound, and affordable hard drives in the Terabyte range can hold weeks of recordings. Laptop computers with large storage capacities now constitute convenient tools to record and visualize sounds directly in the field. They allow a wide choice of sound inputs, sampling rates, and recording channels. Computers also offer the possibility to schedule recordings, allow wide file naming and meta-tagging (timestamp, location, GPS position, ...). Eventually they can be set up to stream sound over wired or wireless networks making remote recording possible. Unfortunately, their internal batteries empty quickly and ask for alternative powering. Furthermore, the internal sound ports of laptop computers are of moderate quality and do not exceed 48 kHz sampling rate. To

push quality and increase bandwidth, an external sound input device must be connected over USB, FireWire, or PCMCIA, additionally draining energy. Emerging generations of subnotebooks, small tablet PCs and ever-smarter mobile phones with included GPS will further boost the interest in computer based field recording. A few suppliers of digital recorders, data acquisition hardware, considerations on power requirements and further information resources are listed on <http://www.bioacoustics.myspecies.info>.

Ultrasound recording

The output of a bat detector allows the recording and permanent storage of nocturnal bat activity. Digital time-expansion bat detectors equipped with a few Megabytes of RAM may be used to autonomously record slowed down chunks of discontinuous recordings to event recorders. However, until very recently, only limited information of a survey could be stored. A time expansion detector can save short recordings to a voice recorder, revealing species-specific information, but hiding total activity information due to the long storage times of typically tenfold the recording duration.

Alternatively, a heterodyning detector, combined with a talking clock records events on a sound-activated tape recorder. This is not suited to inform about species, but nicely keeps track of total activity at a site, *e.g.* as the number of passes per hour (Fenton, 1970). Tapes from such monitoring boxes must be analysed meticulously by listening to them, including their ultrasonic spurious components (*e.g.* rain, insects). Different listeners may interpret events differently, making reproducible species identification difficult.

The Anabat system has become increasingly popular in some regions, but it is harshly debated in others (Barclay, 1999; O'Farrell *et al.*, 1999). It only records a zero-crossing representation of the original signal, which is not sufficient to properly reflect the acoustic variance exhibited in many bat faunas, but it allows for long-term deployment and autonomous signal activation.

Very recently handheld digital storage bat detectors and loggers emerge, which digitally record ultrasound at high sampling rates and bit depths to large enough media, thus permitting full night monitoring of bat activity (for products see <http://www.bioacoustics.myspecies.info>). Despite their considerable price, combined with automated analyzing and species identification software, such devices promise to become standards and tools of choice for future acoustic bat monitoring. They give not only accurate timing of activity; they also remove human bias from qualitative audiotape analysis, because they allow immediate full spectral analysis of the recorded events.

Automated recording systems (ARS)

Acoustic surveys by human observers are best established in birds. It is an effective method, particularly for the detection of secretive species (Bart, 2005; Conway & Gibbs, 2005). However, increasing interest in long term acoustic monitoring of natural habitats has driven the development of Automatic Recording Systems (ARS), which become increasingly popular and cost-effective

(Brandes, 2008; Hobson *et al.*, 2002; Rempel *et al.*, 2005). Autonomous recording devices could reduce person-hours spent in the field, and lead to a major breakthrough in acoustic monitoring of a wide variety of species, particularly in combination with species recognition algorithms (Frommolt *et al.*, 2008a) and expert listeners.

Most ARS consist of stand-alone processing and storage units, scaling from a simple recorder connected to a timer, to a low-power computer that allows more complex tasks such as scheduled recording or feature triggered on-event recording (*e.g.* amplitude and/or spectral trigger, external sensors). However, energy requirements and storage capacity are still critical delimiters for longer operations.

As with observer based monitoring programs, the design of automated recordings has to be thoroughly planned. Habitat type (transmission conditions), abundance and detectability of target species, as well as the sensitivity and the area covered by an ARS define the number of systems to be deployed and the recording scheme (*e.g.* automated or timed recordings, number of minutes per hour, ...). In temperate regions, anuran populations have a typical aggregate pattern around water resources (Gerhardt & Huber, 2002), thus it is often easy to cover the whole population with one or a few recording sites. Anurans living along rivers or in tropical forests, mammals, birds or even most of the insects have populations more dispersed, which allows only to sample a part of the whole population. Some examples of monitoring programs and equipment are given on <http://www.bioacoustics.myspecies.info>.

Digital recordings, particularly of ultrasound, quickly expand to vast data quantities. However, they can be copied and archived like any digital data to compact disk (CD, up to 700 MB) or digital versatile disk (DVD, up to 5 GB). But that amount of data is quickly sampled in a few nights with the aforementioned loggers, thus the backing up of Terabytes of sound recordings is presently only feasible to more and more affordable hard disk duplicates. The advent of new recordable media in the multi GB range (*e.g.* blue-ray) will eventually alleviate this archiving problem in the near future.

5. Sound repositories

A strict documentation of recordings is a prerequisite for scientific work with sound. It becomes most evident in species rich groups like insects: explicit meta-data have to be attached to a recording, and in case of poorly known faunas, the collection of voucher specimens is necessary. Alternatively, photographs and/or blood or tissue samples should be collected. Sound databases should preferentially contain signals collected from animals in their natural environment, but reliable association of song and well-curated voucher specimen often requires recording of captured individuals, under controlled conditions. Storage and administration of recordings requires a well-structured database, eventually referenced to voucher specimens. To facilitate search, each acoustic file should refer to a metadata set containing species name and all recording parameters, locality and temperature and ideally be annotated with signal parameters (*e.g.* carrier frequency) preferably extracted by automated algorithms.

Carefully curated sound collections are the pre-requisite for reliable identification of animal calls. Traditionally, so-called phonotheks, or Sound Libraries, established huge repositories initially based on analogue tape recordings (e.g. Tierstimmenarchiv Berlin, British Library Sound Archive's wildlife collection or the Macaulay Library of Sounds).

Over time, bioacoustic collections suffer from degradation of the recording media (tapes), and the obsolescence of suitable playback equipment. Digitalisation is time-consuming, but a solution that can keep recordings alive and usable, if the data are stored in an exchangeable standard format (AIFF, WAV) and are regularly transcribed within the lifecycle of one media type (20-40 years) to a more recent one. Most importantly, a presentation on the Internet today is the method of choice to enable access to a wide community of users. The International Bioacoustics Council (<http://www.ibac.info/index.html>) provides a comprehensive list of links to all major sound archives. A portal providing federated access to distinct sound archives, with a unified query tool for sound archives would be highly desirable, and could eventually be implemented through the Global Biodiversity Information Facility (<http://www.gbif.org/>).

6. Sound display and analysis

Today, most bioacoustic signals are digitally recorded (see Technologies section). This allows easy data filing and retrieval for signal analysis, to reveal the species-specific acoustic parameters for the recorded species. Digital recordings can be recorded, played and edited by standard software contained within Windows, Linux, and Apple operating systems. However, additional software packages are needed to visualise songs and quantify relevant parameters such as temporal structure and frequency composition (see Figs 1 & 2). Software ranges from simple freeware to very powerful open source or commercial products, some of which allow implementation of automated detection and recognition algorithms (see <http://www.bioacoustics.myspecies.info>).

The simplest graphical display of a signal is an oscillogram, revealing temporal changes of sound pressure, usually transformed into voltage amplitude by a microphone (top in Figs 1 & 2A-F). Further information is revealed by the frequency composition of a signal at any given moment, generally based on a windowed Fast Fourier Transform (FFT). Most meaningful and widely used is the display of a series of spectra, computed on consecutive and generally overlapping segments of a signal, called a spectrogram (see <http://www.bioacoustics.myspecies.info>). This shows the evolution of the frequency structure (y-axis) of a signal over time (x-axis), where intensity (z-axis) is coded as brightness or on a colour palette (bottom in Figs 1 & 2A-F).

A spectrogram can reveal sound features humans cannot perceive, such as fast frequency or amplitude modulations, or frequency components outside the human hearing range, e.g. infrasounds emitted by some large whales or by elephants (Garstang, 2004), as well as ultrasounds emitted by echolocating dolphins or bats. A real-time spectrograph can continuously display the results of a spectral analysis of incoming sounds, even in the field while recording. Spectrograms can be used to measure characteristics of a signal either manually

or with automated algorithms readily offered by some programs. Nevertheless, a detailed study of the settings and rules of the software and a basic experience in bioacoustics is required to achieve reproducible and meaningful results (see Appendix A & B in Charif *et al.*, 2009; Cortopassi, 2006). Examples of such tools are given below. The Raven-Lite software is even available as a plug-in for web-browsers, allowing web-based, immediate display and analysis of the vast collection of field recordings available at the Macaulay Sound Library (<http://www.macaulaylibrary.org>).

Three methods make ultrasound audible for humans and allow real-time analysis of bat echolocation calls or high-pitched insect sounds in the field: heterodyne frequency shifting, frequency division, and time expansion. Only the latter conserves full signal content. The most advanced bat detectors incorporate all these systems to make ultrasounds audible and recordable (see Parsons & Obrist, 2004 and <http://www.bioacoustics.myspecies.info>). In case of continuous wideband recordings, just slowing down the recording makes the ultrasounds audible.

7. Analysis software

Software for sound editing and generic sound analysis can be found on the Internet, either freeware or open source (e.g. AUDACITY), or commercial, e.g. ADOBE AUDITION (commercial, formerly CoolEdit). Very few programs are dedicated to bioacoustic use and in the following we alphabetically list and summarize the functionality of the more established ones that are actively developed and supported. Other valuable software dedicated to bioacoustics are e.g. ISHMAEL, PRAAT, and SYRINX.

7.1. Avisoft

Avisoft-SASLab Pro is Windows software developed by Raimund Specht (Avisoft Bioacoustics, Berlin, Germany - <http://www.avisoft.com>). Avisoft is a versatile sound analysis, editing, classification and synthesis tool made portable by a dongle copy protection system. It provides analyses including amplitude envelope, FFT, filters, labels, LPC, cepstral analysis, auto- and cross-correlation. Time and frequency measurement can be taken automatically through a sound element detection process. Syllable automated classification can be run by means of a template cross-correlation algorithm and a dedicated pulse train analysis supports the investigation of temporal patterns of both simple pulse trains and burst series. Sounds can be generated with a user-friendly graphical interface. Avisoft includes a tool to manage georeferenced wav-files recorded with a digital field recorder using GPS track log data. Avisoft-RECORDER is a separate application interface for multichannel triggering of hard disk recording systems for e.g. long-term monitoring and acoustic event recording.

7.2. BatSound

Batsound is Windows software (Pettersson Electronics, Sweden - <http://www.batsound.com/psonan.html>) enables the user to digitize a signal using

the computer's built-in sound card, and view its temporal and spectral content using Fourier or zero-crossing analysis. In conjunction with high-speed A/D hardware, the software is also capable of digitizing sounds at 300-500 kHz making real-time recording of unaltered signals possible on laptop computers in the field.

7.3. Raven

Raven is commercial full-featured sound analysis software running on Mac OS X, Linux and Windows. It allows recording, processing, analysing and viewing files in a great variety of ways. It sports automatic measurements of signal characteristics, configurable detectors and correlators and allows batch processing of extensive data sets. The full version can be tested (time-limited) and a less powerful free version is available. The Software supersedes the earlier program Canary, which was only running on Mac OS. The software is actively developed at the Cornell Laboratory of Ornithology (Cornell University, Ithaca, NY, USA) and available from <http://www.birds.cornell.edu/raven>.

7.4. SeaPro

SeaPro (Windows, available in a free version) was developed at CIBRA for bioacoustic research to provide real-time sound analysis capabilities and continuous recording to hard disk (http://www.unipv.it/cibra/res_software_uk.html). For marine mammals ship-based surveys it allows continuous real-time display and recording of multiple channels 24h/day, in 15, 30, or 60 minutes long geo- and time-referenced wav files. For browsing wav files collections, it allows high-speed display, and playback at lower or higher speed. It can also be programmed to do scheduled recordings or to record only when sound energy exceeds a given threshold in a user defined frequency range.

7.5. Seewave

Seewave (Sueur *et al.*, 2008) is an extension of R, an open source environment (Windows, MacOS, Linux, FreeBSD) for data manipulation, calculation, statistical computing and graphic display. Seewave is command-line driven allowing users to adapt embedded functions to their own needs, to write their personal functions for new analysis or to develop scripts for batch processing. Sounds are edited as oscillogram or envelope in single or multi-framed windows. Signal and silence durations can be automatically measured. In the frequency domain, several statistical descriptive parameters (dominant peak, quality factor, entropy, spectral flatness, ...) can be extracted. The fundamental frequency of harmonic series is detected by the autocorrelation or cepstral method, while the instantaneous frequency is obtained by the zero-crossing method or Hilbert transform. Seewave provides 2D and 3D spectrograms. Cross-correlations, surface computation and coherence between two samples can be computed. Any mathematical operations between different sounds can be achieved. Amplitude filters, frequency filters, linear frequency shifts are also available.

7.6. Song Scope

Song Scope is another software available to automatically detect animal songs in large series of field recordings. This is a package for Windows, Mac and Linux platform developed by Wildlife Acoustics Inc. (<http://www.wildlifeacoustics.org>). The program uses complex digital signal processing algorithms that are based on Hidden Markov Models (HMM). The Song Scope's models or recognizers are built from training data of the species vocalizations (annotations) and after setting several parameters it is capable to accurately identify species in field recordings. The algorithm considers the spectral and temporal features of individual syllables and how syllables are organized into more complex songs. To identify sounds, Song Scope requires training data of every target species, e.g. from high quality recordings from sound libraries. The software allows extensive control over temporal and spectral settings, which reversely requires some knowledge and learning of the settings.

7.7. X-Bat

The software X-Bat was developed at the Bioacoustics Research Program of the Cornell Laboratory of Ornithology (Cornell University, Ithaca, NY, USA - <http://xbat.org>). This software is a free extensible sound analysis application but it requires the commercial MatLab platform. X-Bat runs under Windows, Linux and Mac OS X and is especially useful to work with large-scale sound data where it still responds quickly and efficiently. X-Bat contains highly adjustable 'Data Template' detectors (spectrogram cross-correlator) for the efficient detection of signal types in large data sets. Furthermore, X-Bat allows to include new functions for specific tasks by scripts programmed in the MatLab language.

8. Bioacoustic inventories

The concept of biodiversity encompasses several levels of biotic variation - from alleles to landscapes - and has thus lead to a plethora of assessment methods (Purvis & Hector, 2000). Species richness is an important aspect of biodiversity (Magurran, 2004) and bioacoustics offers an access to measure it (Fig. 3). Compared to established collecting methods like catching and trapping, visual or auditory contact is probably the easiest way to substantiate a species' occurrence and estimate biodiversity.

An acoustic inventory may cover a majority of species in some taxonomic groups (birds, bats, Orthoptera), but it will still be an incomplete estimation of total biodiversity, as it is limited to a set of acoustically conspicuous species.

The simplest acoustic surveys consist of write-downs of audible sounds heard by human ear. Scientific scrutiny requires a proof of observation, a sound recording, which can be subject to spectrographic viewing (Diwakar *et al.*, 2007) or sound analysis (Riede, 1993; 1997) to support auditory identification. Recordings can ease and fasten the assessment process, enable double-checks of species identification, and thereby reduce inter-observer variance.

Where experts are scarce or species unknown, parataxonomic classification of morphospecies or Recognizable Taxonomic Units (RTU), could be applicable, an approach undertaken in Rapid Biodiversity Assessment (RBA) programs (Basset *et al.*, 2000; Oliver & Beattie, 1993).

8.1. Survey Methods

Point-counts or acoustic identifications along transects are simple methods used mainly for the assessment of amphibian or bird populations. This approach seems efficient, but is limited by the brief observation time, the long expert training, and a potential observer effect (hearing threshold and recognition processes). Recent Automated Digital Recording Systems (ADRS) allow acoustic surveys for extended time periods (Acevedo & Villanueva-Rivera, 2006), gathering data at a fraction of the cost for field observers.

8.2. Automated identification

To further standardise, and gain expert independence, computer-aided call classification and species identification tools have been developed for several taxonomic groups. Different detection and classification methods have been tested on bats, marine mammals, birds, amphibians, and insects (Brandes *et al.*, 2006; Chen & Maher, 2006; Obrist *et al.*, 2004; Parsons & Jones, 2000). Most of these approaches reach respectable recognition rates up to 90%, but rarely cover all species to be expected. Despite the need for extensive preliminary studies to establish templates for recognition, standardized self-running approaches are very attractive for monitoring target groups such as marine mammals or bats, but they remain challenging when investigating taxon-rich communities.

8.3. Rapid Acoustic Survey, ambience or soundscape recording

A fairly new acoustic approach goes beyond the species level, measuring bioacoustic diversity for the entire community. A Rapid Acoustic Survey (RAS) analyses the whole soundscape produced by the local animal community and gets a global measure of it (Sueur *et al.*, 2008). As such, RAS goes beyond a RBA by trying to identify neither species nor phonotypes, but rather assess both temporal and frequency heterogeneity – or entropy – of the composite soundscape produced by the acoustic community. Because of competition for sound niches in time and frequency, a more heterogeneous spectrum and amplitude envelope can be expected from a higher biodiversity of singing animals. Signal entropy was quantified by a Shannon-like formula, producing a surrogate for α biodiversity at a certain locality and for a certain time (the algorithm is available within the R acoustic package “seewave”: Sueur *et al.*, 2008). Beta diversity can then be calculated from the acoustic dissimilarity between pairs of recordings, which exhibit envelope and spectral surface differences. So far RAS has only been tested on simulated communities and on the dawn and dusk soundscapes of two coastal forests in Tanzania. All simulations and tests were promising and revealed significant acoustic

differences between the two African forests, with a lower α index for the forest disturbed by logging. The method has now to be tested in different habitats – temperate and tropical, terrestrial and aquatic – on broader time and spatial scales. Results should also to be confronted with classical surveys. RAS will not replace classical surveys based on a knowledge in taxonomy but will rather help in getting a fast estimation of local diversity, and rapid results can be obtained by untrained personnel.

Even if they do not solve the classical sampling problems encountered by other biodiversity surveys and even if they are sensitive to noise, all acoustic methods reported here can be considered as a valuable tool when documenting biodiversity. Automatisations and availability of recording stations will increase in the next years and provide valuable baseline data to identify hotspots of biodiversity. Efficient data processing and linking of stations will allow timely detection of biodiversity declines, which is necessary for pinpointing current alarming threats to biodiversity.

9. Setting up an inventory

The appropriate procedure for bioacoustic recording depends on the purpose and animal group. You can spend a lot of money in high-sensitivity condenser microphones, only to realise that they do not work during rainforest dusk, when you always have the atmosphere saturated with humidity. This will cause hissing in the condenser microphone membranes, unless you use a (even more expensive) heating device. However, much cheaper electret microphones work fine.

At present, no generally accepted standard protocol for bioacoustic monitoring is available, and quite distinct procedures are used depending on the taxonomic group (e.g. for South American frogs and insects, see Brandes 2005). The key at the end of this paper should help the novice to select the appropriate bioacoustic technique. However, there are still a variety of pitfalls and major crosscutting issues to be carefully considered during bioacoustic work, some of which will be discussed below. In any case, it is highly recommended to discuss major bioacoustic projects with experienced researchers.

9.1. Detection space

Any acoustic monitoring has to take into consideration the active space of the recording situation, defined as “that distance from the source over which its amplitude remains above the detection threshold of potential receivers” (Brenowitz, 1982). The detection space depends on sender (calling animal), environment (transmission characteristics) and the receiver (microphone, recorder, ...). For an ARS this definition can be extended to the area around the ARS where calls of the target species can be recorded and identified. Detection space determines the number of stations necessary to quantitatively monitor a particular habitat or population, and to compare the data between stations. Although this quantification can be performed empirically with playback tests, it is

often not feasible (e.g. for species assemblages, or for bats) and setting stations to equal recording levels only certifies comparability of relative activity.

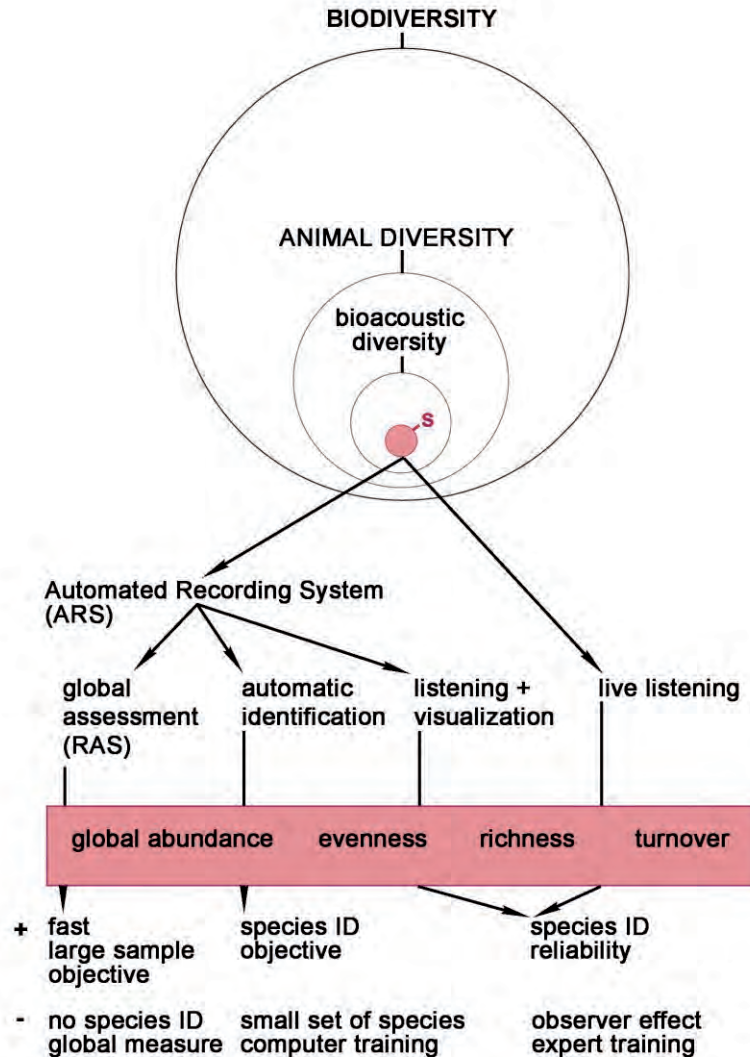

Fig. 3. Scheme of the different acoustic methods currently used to assess biodiversity. Acoustic survey focuses on a selected part of biodiversity. This sample can be directly analysed by the help of expert listeners or by post-recording analyses. All methods try to estimate the main parameters used when measuring biodiversity (global abundance, richness, evenness, and turnover). The main advantages (+) and disadvantages (-) are reported.

9.2. Noise

Noise can have major impacts on both marine and terrestrial ecosystems. Wind and noise coming from human activities (roads, airplanes) also pose a major problem in outdoor recordings. Wind can be attenuated with proper windshields on the microphones, but neither traffic nor competing calling animals (e.g. Orthoptera when interested in bats) can be avoided. Self-noise of microphones is another problem. It is normally expressed with an A-weighted or linear dB value. Values range from below 10 dB(A) for very quiet microphones to above 20 dB(A), which is too high for ambience recordings or quiet sounds.

The possible effects of environmental background noise, sound attenuation by multiple products of distance, humidity and frequency, directionality of emitting bats and recording devices, and last but not least Doppler effects, on ultrasound recordings are all comprehensively reviewed by Pye & Langbauer (1998).

9.3. Mechanical sturdiness and damage

Microphones are the most vulnerable parts of any recording chain. Some commercially available units have somewhat weather resistant membranes but it is essential to prevent direct contact between the microphone capsule and water. Possible protective measures are detailed (<http://www.bioacoustics.myspecies.info>).

Finally, the possibility of wilful human (or animal) destruction always exists and recording devices may have to be accordingly camouflaged, hidden or protected.

9.4. Anti-Aliasing recordings

When digitizing analogue signals, sampling rates must be at least twice the rate of the highest signal expected in the recording. Undersampled signals depict artificial spurious components in the spectrogram display. Thus, a low-pass-filtering adept to the digitizing hardware should be employed to the incoming signal. Most recorders and A/D converter boxes incorporate decent filters, but aliasing occasionally may still appear in spectrograms of very loud components of sounds (see http://www.unipv.it/cibra/res_techtest_uk.html).

9.5. Clipping

Outdoor recordings may contain a sequence of vocalisations calls emitted by a passing animal (e.g. flying bat). During a passage by the microphone, the recorded signal's intensity changes. If the intensity of a recorded signal surpasses the upper limit of the recording system (detector, tape, A/D-converter), the signal will be clipped, setting recorded values constantly to the maximum level recordable, thus creating spectral components not present in the original signal. When visually monitoring playbacks such overload signals can easily be identified.

9.6. Doppler effects and more

Depending on speed and frequency of a sender, a resulting Doppler effect can amount to several kHz at the peak energy of *e.g.* echolocation calls in bats, thereby easily surpassing interindividual variability (Obrist, 1995). This can seriously hamper the identification of species, which occur concurrently and show overlap of frequency bands due to Doppler-effects created by different flight speeds or directions (*e.g.* *Pipistrellus nathusii* and *Pipistrellus kuhli*). Bats hunting concurrently may also interact acoustically, thereby altering their preferred frequency range considerably (Habersetzer, 1981; Obrist, 1995). In such cases, species may be confused unless the track of calls is acoustically and visually verified by an observer on a spectrogram. When recording with a digital system, it is advisable to keep the peak amplitude well below the 0 dB mark on the level display.

10. Key for the selection of bioacoustic procedures

The following key systematises the wide variety of available bioacoustic techniques and purposes. Together with the online material accompanying this manual, it hopefully stimulates biodiversity researchers to enrich inventories with bioacoustic data.

10.1. Recordings for personal reference and later use of bioacoustic keys, or as evidence for occurrence of a certain species.

A wide variety of (cheap) equipment can be used, including automatic recording devices using sound compression. Try to join other naturalists interested in “your” target group, and select similar equipment and protocols. In any case, annotate and archive your recordings as described below and share your data and make them available through web2.0 sites (<http://observado.org/sound/index>).

10.2. Recordings for scientific use, such as detailed song analysis or for taxonomic description.

10.2.1. Target taxon generates audible sound.

- Target taxon vocalises and can be recorded **in captivity**.

More detailed and sophisticated measurements and recordings can be made in captivity, using soundproof chambers, sound level recorders (db-meters) or laser vibrometer. Experienced bioacousticians usually employ these techniques, but taxonomists also use recording captured individuals, mainly to obtain a voucher specimen. For insects in particular one should always try to obtain voucher specimens from recordings made in captivity. Recordings and specimen should be cross-referenced by adequate labelling and storing in a database; temperature and light conditions must be annotated, together with technical details. Use high sample rates and uncompressed storage formats (*e.g.* wav format). After publication, share your data by depositing recordings in public phonotheks and/or databases.

Voucher specimen should be deposited in a recognised Natural History Museum (this is a must for species descriptions).

- Target taxon recorded **in the field**.

Many taxa do not sing in captivity, are too rare, endangered, and/or protected by law to be caught, or the investigator studies bioacoustic problems in an otherwise well-known species (mostly birds and mammals, but also European insects). Select field-recording equipment adapted to animal group, biotope and budget (see section field recording). Annotate recordings. Use high sample rates and uncompressed storage formats (e.g. wav format). After publication, share your data by depositing recordings in public phonotheks and/or databases.

10.2.2. Target taxon generates ultrasound components.

Species specificity of signals is only guaranteed in open flight situations! Signals emitted in captivity cannot be compared to outdoor recordings and are mostly inappropriate for species identification!

Be aware of the observer effect: bats are curious and sensible and obtrusive observer presence could bias recordings!

- Bat **presence** to be determined (without accurate species identification).

Heterodyning or frequency division bat detector is sufficient.

- **Species** to be determined.

Time expansion detector and digital recorder required. Keep in mind that for the same recording duration digitized ultrasound takes roughly tenfold the data space of audio recordings.

Species identification at a roost.

Stationary recording of the signals at 10-20 meters distance from the roost in the flight path of the emerging bats is required to register standardized orientation calls. Different species leave the roost at different times, thus prolonged recording until about 2 hrs past sunset is recommended.

Species identification at a distinct foraging site, streetlight, pond, ...

Stationary recording of the signals is recommended. Switching the recording position in intervals of ≥ 30 min may detect more species using the site¹.

Species habitat use, presence in a landscape.

Slowly walk a predefined transect: avoid walking on gravel (ultrasound noise!). Dim down your headlight¹.

¹ At least one repetition of the survey is necessary, preferably at different daytimes and seasons to account for different detectability of species. Log date, position, habitat type, type of recording equipment (digitization parameters), as well as wind and temperature conditions. Store the data for future reference and share it with the scientific community by

Stationary recording at several points: record for at least 30 min at each predefined site. If possible use several detectors concurrently¹.

11. Checklist to successful recording

Before you start

Weather

Check weather forecast and avoid rainy and windy days (or use wind protection).

High humidity environments (e.g., tropical rainforests, ponds in cold nights, etc.) may damage your recordings. Care for a replacement microphone.

General equipment

Check your equipment (batteries, leads, connectors, ...).

Always take spare batteries with you.

Know your equipment perfectly: you should be able to run a recording without seeing the buttons of the recorder.

Carry some silica gel in airtight bags to dry microphones when not in use.

Use headphones to monitor the field recording recorder (quality, level, background, ...), and you will be able to correct in advance some problems and improve your recordings.

Calibrate the recording equipment before and after recording sessions with a calibrator device. Together with an accurate measurement of recording distance this is essential to calculate intensity parameters from the recordings. Use identical ARS' and calibrate them to allow later comparison between recording stations.

Microphones

Close sound source expected

Use an omnidirectional or cardioid microphone with a frequency response as flat as possible.

Distant sound source

Use a directional microphone (shotgun microphones or a parabola) to record focused on distant individuals with the best signal to noise ratio.

Consider two-channel recording to record the acoustic context and the focus animal. Different callers at different positions can easier be distinguished in binaural recordings.

depositing recordings in public phonotheks and/or databases. (For further details see Brigham *et al.*, 2004; Kunz, 1988).

Out in the field: noise and site selection

If possible, choose an isolated site, away from all sources of anthropogenic (road, airport, train, city) or natural noise (stream, waterfall), including other acoustically active species not targeted.

Place hydrophones where the water is still. Avoid running water. At sea, suspend the hydrophone with progressive sub-surface floaters to allow it to sink and stay stable at the desired depth, unaffected by surface movements (boat).

Keeping track: the protocol

Have a fieldwork paper book to note as much information as possible you would not remember the day after.

Describe the habitat and more specifically the close environment around the source.

Keep notes of the equipment and take photographs of it and of microphone positions.

Record the local weather parameters (air temperature in the shade, air temperature at the insect position, relative humidity, wind force, cloud cover).

At the beginning and at the end of a recording session, also record verbally all the relevant information you wrote in your field journal: date (yes, including year!), time, localisation (if possible GPS coordinates), weather (especially temperature for amphibians or insects), habitat, background noise, recording equipment, recording author, ...

Give a field identification number to the specimen recorded.

Observer behaviour

Move as little as possible. You may even sit down and let your target animals approach.

Be patient. Before changing your recording site, wait at least 20 minutes. Insects start to sing again!

Make as many comments as possible before or after and not during the recording.

During the session, only record verbally *e.g.* subject changes, which will be useful for later analysis. This should also be done every time an ARS is set in the field or serviced.

Recording

Keep similar distances to subjects: one meter is usually a good distance for insects.

Direct the microphone away from possible noise sources.

Avoid the recording of sound reflected from surfaces (ground, water) by pointing the microphone at the subject in parallel to that surface.

Avoid overloaded recordings: don't put the recording level too high (recorder clipping risk) and don't put the microphone too close to the source (microphone clipping risk).

Regularly check the input sound level during recording, and learn how to detect a clipped signal by listening to the headphones.

High bit-depth digital recorders give good recordings even with reduced recording levels.

Use a sampling rate reasonably higher than strictly needed, to preserve the wider spectral context in which a vocalization occurs.

Housekeeping

Transfer all your data to a laptop computer and/or an external hard disk. Be sure that no digital re-sampling occurs when transferring the original files. Try to transfer daily to avoid confusion between files.

Organize and name your files and folders very clearly.

Lock the recorded files in order to preserve the creation date (some sound editors will modify the metadata of the file as soon as you open them).

Generate a database (from a table to a true database) describing your recordings.

Keep note of the recording settings (number of channels, bits and format, sampling rate); if a file header is corrupted, this helps to recover the file.

Backup your data.

Deposit the recordings in a scientific sound library.

Analysis

Set spectrographic parameters carefully (windowing, overlap, FFT-size). To match slowly or quickly changing sound parameters (*e.g.* whole insect chirps or individual pulses within the chirps) you may need two different settings.

Use those constant time-frequency scales, dB scales and spectrogram size to make comparisons easier. Take note of the settings (*e.g.* screen capture).

Avoid too much filtering or noise reduction except low noisy frequencies (wind etc.)

Take robust temporal and spectral measures (Cortopassi 2006).

12. Acknowledgements

We want to express our thanks for the support to Spanish Ministry of Science and Innovation (projects: CGL2008-04814-C02-01/BOS-Acoura and CGL2008-04767-E). We thank an anonymous reviewer and Karl-Heinz Frommolt for their reviewing of earlier versions of the text, contributing to an improved manuscript.

13. References

- ACEVEDO, M.A. & VILLANUEVA-RIVERA, L.J. 2006. Using automated digital recording systems as effective tools for the monitoring of birds and amphibians. *Wildlife Society Bulletin* 34: 211-214.
- AHLÉN, I. 1981. *Identification of scandinavian bats by their sounds*. The Swedish University of Agricultural Sciences, Department of Wildlife Ecology, Uppsala: 56.
- BARCLAY, R.M.R. 1999. Bats are not birds - a cautionary note on using echolocation calls to identify bats: A comment. *Journal of Mammalogy* 80: 290-296.
- BARDELI, R., WOLFF, D. & CLAUSEN, M. 2008. Bird song recognition in complex audio scenes. In: FROMMOLT, K.-H., BARDELI, R. & CLAUSEN, M. (Eds). *International Expert meeting on IT-based detection of bioacoustical pattern*. Federal Agency for Nature Conservation, International Academy for Nature Conservation (INA), Isle of Vilm. BfN-Skripten 234: 93-102.
- BART, J. 2005. Monitoring the abundance of bird populations. *The Auk* 122: 15-25.
- BASSET, Y., NOVOTNY, V., MILLER, S.E. & PYLE, R. 2000. Experience with parataxonomists and digital photography in Papua New Guinea and Guyana. *Bioscience* 50: 899-908.
- BRANDES, T.S. 2005. *Tropical ecology, assessment, and monitoring (team) initiative: Acoustic monitoring protocol*. Version 2.1.: 15 pp. [<http://www.teamnetwork.org/files/protocols/amphibian/TEAMAcoustic-PT-EN-2.1.pdf>].
- BRANDES, T.S. 2008. Feature vector selection and use with hidden markov models to identify frequency-modulated bioacoustic signals amidst noise. *IEEE Transactions on Audio, Speech, and Language Processing* 16: 1173-1180.
- BRANDES, T.S., NASKRECKI, P. & FIGUEROA, H.K. 2006. Using image processing to detect and classify narrow-band cricket and frog calls. *Journal of the Acoustical Society of America* 120: 2950-2957.
- BRENOWITZ, E.A. 1982. The active space of the red winged blackbird song. *Journal of Comparative Physiology* 147: 511-522.
- BRIGHAM, R.M., KALKO, E.K.V., JONES, G., PARSONS, S. & LIMPENS, H.J.G.A. (Eds) 2004. *Bat echolocation research. Tools, techniques and analysis*. Bat Conservation International, Austin TX: 167 pp.
- BRILLET, C. & PAILLETTE, M.G. 1991. Acoustic signals of the nocturnal lizard *Gekko gekko*: Analysis of the long complex sequence. *Bioacoustics* 3: 33-44.
- CHARIF, R.A., WAACK, A.M. & STRICKMAN, L.M. 2009. *Raven pro 1.4 user's manual*. Cornell Laboratory of Ornithology, Ithaca NY: 332 pp. [<http://www.birds.cornell.edu/brp/raven/RavenDocumentation.html>]

- CHEN, Z.X. & MAHER, R.C. 2006. Semi-automatic classification of bird vocalizations using spectral peak tracks. *Journal of the Acoustical Society of America* 120: 2974-2984.
- COCROFT, R.B. & MCNETT, G.D. 2006. Vibrational communication in treehoppers (Hemiptera: Membracidae). In: DROSOPOULOS, S. & CLARIDGE, M.F. (Eds). *Insect sounds and communication: Physiology, behaviour, ecology, and evolution*. Taylor & Francis Group, Boca Raton, London, New York: 305-317.
- CONWAY, C.J. & GIBBS, J.P. 2005. Effectiveness of call-broadcast surveys for monitoring marsh birds. *The Auk* 122: 26-35.
- CORTOPASSI, K.A. 2006. *Automated and robust measurement of signal features*. Cornell Laboratory of Ornithology, Ithaca, NY. [<http://www.birds.cornell.edu/brp/research/algorithm/automated-and-robust-measurement-of-signal-features/>]
- DIERSCHKE, V. 1989. Automatisch-akustische erfassung des nächtlichen vogelzuges bei helgoland im sommer 1987. *Die Vogelwarte* 35: 115-131.
- DIWAKAR, S., JAIN, M. & BALAKRISHNAN, R. 2007. Psychoacoustic sampling as a reliable, non-invasive method to monitor orthopteran species diversity in tropical forests. *Biodiversity and Conservation* 16: 4081-4093.
- EVANS, W. & MELLINGER, D. 1999. Monitoring grassland birds in nocturnal migration. *Studies in Avian Biology* 19: 219-229.
- FAVARETTO, A., DE BATTISTI, R. & PAVAN, G. 2006. Acoustic features of red deer (*Cervus elaphus*) stags vocalizations in the cansiglio forest (NE italy, 2001-2002). *Advances in Bioacoustics II, Proceedings of the XX International Bioacoustics Congress (Piran, Slovenia, 2005)*: 125-138.
- FENTON, M.B. 1970. A technique for monitoring bat activity with results obtained from different environments in southern Ontario. *Canadian Journal of Zoology* 48: 847-851.
- FENTON, M.B. & BELL, G.P. 1981. Recognition of species of insectivorous bats by their echolocation calls. *Journal of Mammalogy* 62: 233-243.
- FROMMOLT, K.-H., BARDELI, R. & Clausen, M. 2008a. Computational bioacoustics for assessing biodiversity. *International Expert meeting on IT-based detection of bioacoustical pattern*. Federal Agency for Nature Conservation, International Academy for Nature Conservation (INA), Isle of Vilm. BfN-Skripten 234: 160 pp.
- FROMMOLT, K.-H., TAUCHERT, K.-H. & KOCH, M. 2008b. Advantages and disadvantages of acoustic monitoring of birds - realistic scenarios for automated bioacoustic monitoring in a densely populated region. In: Frommolt, K.-H., Bardeli, R. & Clausen, M. (Eds). *International Expert meeting on IT-based detection of bioacoustical pattern*. Federal Agency for Nature Conservation, International Academy for Nature Conservation (INA), Isle of Vilm. BfN-Skripten 234: 83-92.
- FULLER, T.K. & SAMPSON, B.A. 1988. Evaluation of a simulated howling survey for wolves. *The Journal of Wildlife Management* 52: 60-63.

- GAINES, W., NEALE, G. & NANEY, R. 1995. Response of coyotes and gray wolves to simulated howling in north-central Washington. *Northwest Science* 69(3): 217-222.
- GALEOTTI, P. & PAVAN, G. 1991. Individual recognition of male Tawny owls (*Strix aluco*) using spectrograms of their territorial calls. *Ethology, Ecology & Evolution* 3: 113-126.
- GARSTANG, M. 2004. Long-distance, low-frequency elephant communication. *Journal of Comparative Physiology A* 190: 791-805.
- GERHARDT, C. & HUBER, F. 2002. *Acoustic communication in insects and anurans: Common problems and diverse solutions*. University of Chicago Press, Chicago & London: 542 pp.
- GRABER, R.R. 1968. Nocturnal migration in Illinois: Different points of view. *The Wilson Bulletin* 80: 36-71.
- GRIFFIN, D.R. 1958. *Listening in the dark. The acoustic orientation of bats and men*. Yale University Press, New Haven. (reprint by Cornell University Press, Ithaca, New York 1986).
- HABERSETZER, J. 1981. Adaptive echolocation sounds in the bat *Rhinopoma hardwickei*. *Journal of Comparative Physiology* 144: 559-566.
- HASELMAYER, J. & QUINN, J.S. 2000. A comparison of point counts and sound recording as bird survey methods in amazonian southeast Peru. *The Condor* 102: 887-893.
- HOBSON, K.A., REMPEL, R.S., HAMILTON, G., TURNBULL, B. & WILGENBURG, S.L.V. 2002. Acoustic surveys of birds using electronic recordings: New potential from an omnidirectional microphone system. *Wildlife Society Bulletin* 30: 709-720.
- JANSSON, A. 1973. Stridulation and its significance in the genus *Cenocorixa* (Hemiptera, Corixidae). *Behaviour* 46: 1-36.
- JENNINGS, N., PARSONS, S. & POCKOCK, M.J.O. 2008. Human vs. Machine: Identification of bat species from their echolocation calls by humans and by artificial neural networks. *Canadian Journal of Zoology* 86: 371-377.
- JOHNSON, M., MADSEN, P.T., ZIMMER, W.M.X., SOTO, N.A.D. & TYACK, P.L. 2004. Beaked whales echolocate on prey. *Proceedings of the Royal Society of London Series B – Biological Sciences*. Suppl. 271: S383–S386.
- JOHNSON, M.P. & TYACK, P.L. 2003. A digital acoustic recording tag for measuring the response of wild marine mammals to sound. *IEEE Journal of Oceanic Engineering* 28: 3-12.
- KUHN, B. & SCHNEIDER, R.H. 1984. Mating and territorial calls of the frog *Rana ridibunda* and their temperature variability. *Zoologischer Anzeiger* 212: 273-305.
- KUNZ, T.H. (Ed.) 1988. *Ecological and behavioural methods for the study of bats*. Smithsonian Institution, Washington D.C. & London: 533 pp.

- LADICH, F., BISCHOF, C., SCHLEINZER, G. & FUCHS, A. 1992. Intra- and interspecific differences in agonistic vocalization in croaking gouramis (genus: *Trichopsis*, Anabantoidei, Teleostei). *Bioacoustics* 4: 131-141.
- LAILOLO, P., VÖGELI, M., SERRANO, D. & TELLA, J.L. 2007. Testing acoustic versus physical marking: two complementary methods for individual-based monitoring of elusive species. *Journal of Avian Biology* 38(6): 672-681.
- LAWRENCE, B.D. & SIMMONS, J.A. 1982. Measurements of atmospheric attenuation at ultrasonic frequencies and the significance for echolocating bats. *Journal of the Acoustical Society of America* 71: 585-590.
- MAGURRAN, A.E. 2004. *Measuring biological diversity*. Blackwell, Oxford: 256 pp.
- MARCELLINI, D.L. 1974. Acoustic behavior of the gekkonid lizard, *Hemidactylus frenatus*. *Herpetologica* 30: 44-52.
- MARQUEZ, R. & BOSCH, J. 1995. Advertisement calls of the midwife toads alytes (Amphibia, Anura, Discoglossidae) in continental Spain. *Journal of Zoological Systematics and Evolutionary Research* 33: 185-192.
- MÁRQUEZ, R., LLUSIA, D., BELTRÁN, J.F., DO AMARAL, J.P. & BOWKER, R.G. 2008. Anurans, the group of terrestrial vertebrates most vulnerable to climate change: A case study of acoustic monitoring in the iberian peninsula. In: Frommolt, K.-H., Bardeli, R. & Clausen, M. (Eds). *International Expert meeting on IT-based detection of bioacoustical pattern*. Federal Agency for Nature Conservation, International Academy for Nature Conservation (INA), Isle of Vilm. BfN-Skripten 234: 43-52.
- MCGREGOR, P.K. 1992. *Playback studies of animal communication: Problems and prospects*. Plenum Press, New York: 231 pp.
- O'FARRELL, M.J., MILLER, B.W. & GANNON, W.L. 1999. Qualitative identification of free-flying bats using the anabat detector. *Journal of Mammalogy* 80: 11-23.
- OBRIST, M.K. 1995. Flexible bat echolocation: The influence of individual, habitat and conspecifics on sonar signal design. *Behavioral Ecology and Sociobiology* 36: 207-219.
- OBRIST, M.K., BOESCH, R. & FLÜCKIGER, P.F. 2004. Variability in echolocation call design of 26 swiss bat species: Consequences, limits and options for automated field identification with a synergetic pattern recognition approach. *Mammalia* 68: 307-322.
- OBRIST, M.K., BOESCH, R. & FLÜCKIGER, P.F. 2008. Probabilistic evaluation of synergetic ultrasound pattern recognition for large scale bat surveys. In: FROMMOLT, K.-H., BARDELI, R. & CLAUSEN, M. (Eds). *International Expert meeting on IT-based detection of bioacoustical pattern*. Federal Agency for Nature Conservation, International Academy for Nature Conservation (INA), Isle of Vilm. BfN-Skripten 234: 29-42.
- OLIVER, I. & BEATTIE, A.J. 1993. A possible method for the rapid assessment of biodiversity. *Conservation Biology* 7: 562-568.

- PARSONS, S. & JONES, G. 2000. Acoustic identification of twelve species of echolocating bat by discriminant function analysis and artificial neural networks. *Journal of Experimental Biology* 203: 2641-2656.
- PARSONS, S. & OBRIST, M.K. 2004. Recent methodological advances in the recording and analysis of chiropteran biosonar signals in the field. *In: THOMAS, J., MOSS, C. & VATER, M. (Eds). Echolocation in bats and dolphins. Proceedings of the biosonar conference 1998. University of Chicago Press, Chicago: 468-477.*
- PURVIS, A. & HECTOR, A. 2000. Getting the measure of biodiversity. *Nature* 405: 212-219.
- PYE, J.D. 1992. Equipment and techniques for the study of ultrasound in air. *Bioacoustics* 4: 77-88.
- PYE, J.D. 1993. Is fidelity futile? The true signal is illusory, especially with ultrasound. *Bioacoustics* 4: 271-286.
- PYE, J.D. & LANGBAUER, W.R. 1998. Ultrasound and infrasound. *In: HOPP, S.L., OWREN, M.J. & EVANS, C.S. (Eds). Animal acoustic communication: Sound analysis and research methods. Springer-Verlag, Berlin & Heidelberg: 221-250.*
- REMPEL, R.S., HOBSON, K.A., HOLBORN, G., WILGENBURG, S.L.V. & ELLIOTT, J. 2005. Bioacoustic monitoring of forest songbirds: Interpreter variability and effects of configuration and digital processing methods in the laboratory. *Journal of Field Ornithology* 76: 1-11.
- RIEDE, K. 1993. Monitoring biodiversity: Analysis of amazonian rainforest sounds. *Ambio* 22: 546-548.
- RIEDE, K. 1997. Bioacoustic monitoring of insect communities in a bornean rainforest canopy. *In: STORK, N.E., ADIS, J. & DIDHAM, R.K. (Eds). Canopy arthropods. Chapman & Hall, London: 442-452.*
- RUMSEY, F. & MCCORMICK, T. 2006. *Sound and recording - an introduction. Focal Press, Elsevier: 569 pp.*
- RUSO, D. & JONES, G. 2002. Identification of twenty-two bat species (Mammalia: Chiroptera) from Italy by analysis of time-expanded recordings of echolocation calls. *Journal of Zoology, London* 258: 91-103.
- SCHRAMA, T., POOT, M., ROBB, M. & SLABBEKOORN, H. 2008. Automated monitoring of avian flight calls during nocturnal migration. *In: Frommolt, K.-H., Bardeli, R. & Clausen, M. (Eds). International Expert meeting on IT-based detection of bioacoustical pattern. Federal Agency for Nature Conservation, International Academy for Nature Conservation (INA), Isle of Vilm. BfN-Skripten 234: 131-134.*
- SENGPIEL, E. 2010. Conversion of sound units. [<http://www.sengpielaudio.com/calculator-soundlevel.htm>]
- SKOWRONSKI, M.D. & HARRIS, J.G. 2006. Acoustic detection and classification of microchiroptera using machine learning: Lessons learned from automatic speech recognition. *The Journal of the Acoustical Society of America* 119: 1817-1833.

- SUEUR, J. 2006. Insect species and their song. *In*: Drosopoulos, S. & Claridge, M. (Eds). *Insect Sounds and Communication: Physiology, Behaviour, Ecology, and Evolution*, Taylor and Francis, CRC Press, New York: 207-217.
- SUEUR, J., PAVOINE, S., HAMERLYNCK, O. & DUVAL, S. 2008. Rapid acoustic survey for biodiversity appraisal. *PLoS ONE*, 3/12: e4065.
- SUEUR, J. & PUISSANT, S. 2007. Similar look but different song: A new cicadetta species in the montana complex (Insecta, Hemiptera, Cicadidae). *Zootaxa* 1442: 55-68.
- TANTTU, J.T. & TURUNEN, J. 2008. Computational methods in analysis of bird song complexity. *In*: Frommolt, K.-H., Bardeli, R. & Clausen, M. (Eds). *International Expert meeting on IT-based detection of bioacoustical pattern*. Federal Agency for Nature Conservation, International Academy for Nature Conservation (INA), Isle of Vilm. BfN-Skripten 234: 125-129.
- TODT, D. & HULTSCH, H. 1996. Ecology and evolution of communication in birds. *In*: KROODSMA, D.E. & MILLER, E.H. (Eds). *Ecology and evolution of acoustic communication in birds*. Cornell University Press, Ithaca NY: 79-96.
- TORRICELLI, P., LUGLI, M. & PAVAN, G. 1990. Analysis of sounds produced by male *Padogobius martensi* (Pisces, Gobiidae) and factors affecting their structural properties. *Bioacoustics* 2: 261-275.
- VANNONI, E. & McELLAGOTT, A.G. 2007. Individual acoustic variation in fallow deer (*Dama dama*) common and harsh groans: A source-filter theory perspective. *Ethology* 113: 223-234.
- VERGNE, A.L., PRITZ, M.B. & MATHEVON, N. 2009. Acoustic communication in crocodylians: From behaviour to brain. *Biological Reviews* 84: 391-411.
- WALKER, T.J. 1964. Cryptic species among sound-producing ensiferan Orthoptera (Gryllidae and Tettigoniidae). *Quarterly Review of Biology* 39: 345-355.
- WILSON, G.J. & DELAHAY, R.J. 2001. A review of methods to estimate the abundance of terrestrial carnivores using field signs and observation. *Wildlife Research* 28: 151-164.

Chapter 6

Camera trapping for inventorying terrestrial vertebrates

by

Francesco Rovero

Tropical Biodiversity, Museo Tridentino di Scienze Naturali,
Via Calepina 14, 38122 Trento, Italy &
Udzungwa Ecological Monitoring Centre,
c/o Udzungwa Mountains National Park,
P.O. Box 99, Mang'ula, Tanzania
Email: francesco.rovero@mtsn.tn.it

Mathias Tobler

Andes to Amazon Biodiversity Program, Botanical Research Institute of Texas,
500 E. 4th Street Fort Worth, Texas 76102-4060, USA
Email: matobler@gmx.net

James Sanderson

Small Cat Conservation Alliance, Wildlife Conservation Network,
27545 Bassett Lane, Los Altos, CA 94022 USA
Email: gato_andino@yahoo.com

Abstract

The use of automatic cameras triggered by passing animals (camera trapping) is a fundamental technique to record medium to large mammals and terrestrial birds in the field. Photographs provide objective records, or evidence, of an animal's presence and identity. The method underwent enormous advance and has been increasingly used in the last decade. Besides faunal inventories and assessments of activity pattern, relative abundance and habitat preference, inferential sampling studies using camera traps allow estimations of occupancy and density. As such, camera trapping is a fundamental method for All Taxa Biodiversity Inventory (ATBI) projects. Following an introduction with historical background, we describe the various phases of using camera trapping with ample details on the practical aspects from the choice of camera model and setting of cameras in the field to the analysis of photographs, and storing and management of data. Key study designs and analytical procedures are described, particularly species inventory and occupancy studies, and their application to design monitoring programmes.

Key words: phototrapping, checklist, mammals, survey, occupancy

1. Introduction

Camera trapping refers to the use of remotely triggered cameras that automatically take images of whatever walks in front of them. Most camera trap models are triggered by a passive infrared sensor detecting a moving object warmer than the ambient temperature such as animals, people, or vehicles passing in front of them. Camera trapping is most often used to capture images of medium to large sized terrestrial mammals and birds, but has also been recently used for arboreal mammals (Oliveira-Santos *et al.*, 2008). Camera trapping methodology underwent significant advances and has been increasingly used in the last decade (O'Connell *et al.*, in press). The number of publications per year that investigated or used camera trapping increased from less than five during 1993-2003 to 55 in 2008 (Rowcliffe & Carbone, 2008, using the topic search tool in the Web of Science) and by 2009 has increased to around 150 publications. Camera traps have been used to record fauna in a wide range of habitats, from snow leopard in the Himalayas (Jackson *et al.*, 2006) and bobcat in northern California (Laruccia *et al.*, 2007) to a wealth of studies in the humid tropics (e.g. Karanth & Nichols, 1998; Rovero & De Luca, 2007; Tobler *et al.*, 2008a). Camera traps were used to obtain the first pictures in the wild of the Chinese mountain cat (Sanderson, 2007; Yufen *et al.*, 2007) and Abbott's duiker (Rovero *et al.*, 2005), and to detect a new species of giant elephant-shrew (Rovero *et al.*, 2008). Besides their use for carrying out faunal inventories and obtaining information on activity pattern and habitat preference, scientifically robust, inferential sampling studies using camera traps can allow to estimate occupancy and density.

Following a historical background of camera trapping, key advantages of camera traps are presented. Also included is a detailed guide on the use of camera traps. Many useful details are provided, including how to choose a camera trap model and the practicalities of placing camera traps in the field. The analysis of photographs, image management including data storage, and data analysis are also discussed.

History of camera trapping

Camera trapping was invented in the late 1890s by George Shiras III, a Yale-educated lawyer who perfected a way of photographing wildlife at night with a large-format camera and hand-operated flash. Shiras soon gained considerable acclaim for his stunning night photographs of deer and other animals (Sanderson & Trolle, 2005). The first camera trap photos were taken when Shiras set up his camera so that he could take a picture remotely by pulling on a long trip-wire. Eventually, he arranged the trip-wire so that an animal triggered the camera. His articles in *The National Geographic Magazine* from 1906 to 1921 created considerable interest in wildlife photography (Shiras, 1913). Subsequently, in the late 1920s, Shiras taught Frank M. Chapman (a leading ornithologist from the American Museum of Natural History in New York) how to use camera traps for his work in the tropical rain forest of Barro Colorado Island in Panama. Chapman employed Shiras' camera traps to capture images of the diverse and, at that

time, poorly known fauna, including tapirs, ocelots and pumas. For many years, Chapman was one of the few researchers to use camera traps. Several decades passed before researcher re-discovered camera traps as a tool. Seydack (1984) was probably the first to use automatic camera traps to study rainforest mammals. He collected data for inventorying species as well as estimate bushbuck abundance and identify individual leopards in Africa. Griffiths & van Schaik (1993) used camera-taps to study rainforest mammals in Indonesia, and realized the potential of this method to detect species presence and study behaviour, activity patterns and abundance of elusive mammals (Griffiths & van Schaik, 1993; van Schaik & Griffiths, 1996). Meanwhile, Karanth employed camera traps to identify individual tigers in Nagarahole National Park, India. His success with applying capture-recapture models to estimate density from camera trap data (Karanth & Nichols, 1998) moved camera trapping towards the realm of science-based, inferential sampling, thus leading the way for camera trapping to become an important tool for quantitative wildlife research (O'Connell *et al.*, in press).

Hunters, especially in the USA, began using camera traps in the late 1990s to search for trophy deer and other big-game species. This created a small industry resulting in an increasing number of camera trap models spanning a range of prices. At the same time, technology advanced quickly and modern camera traps now have water-proof plastic enclosures containing small, "point-and-shoot" film or digital cameras triggered by passive infrared sensors. Over the last few years, digital and video camera traps have begun replacing film cameras and new models are being introduced each year. Thanks to these advances, camera trapping has become a widely used tool in wildlife biology, opening the way to an impressive number of studies (Rowcliffe & Carbone, 2008).

Advantages and efficiency of camera trapping

Camera trapping is a non-invasive method that generally causes a minimum of disturbance to the target species. Camera traps can be left unattended in the field for several weeks, and thus are ideally suited for studying rare, elusive, and nocturnal/crepuscular animals that avoid humans. The big advantage of camera trapping in comparison to other methods used to record medium-sized to large terrestrial mammals (see chapter 19 by Hoffmann *et al.*) is that photographs provide objective records, or evidence, of an animal's presence and identity. In addition, camera trapping provides information on activity patterns (from the date and time contained in the image), behaviour, and pelage characteristics that enable individual identification.

Various studies show that camera trapping is an efficient method for inventorying the community of medium to large terrestrial mammals, with 57 to 86% of species detected using survey effort of 1035 to 3400 camera trap days (Table 1). A study in Suriname shows that the totality of species can potentially be detected when deploying large survey effort. Survey effort is usually measured as the number of camera traps multiplied by the number of sampling days. For example, an effort of 1000 camera trap days can be obtained using 10 camera traps run for 100 days, or 20 camera traps run for 50 days. However, despite the relatively

large proportion of species that can be recorded, some species may not be detected even after several thousands of camera trap days (Tobler *et al.*, 2008a). This has important implications when designing a study because (1) large trap effort does not guarantee survey completeness, and (2) failure to detect a species does not mean the species is absent.

Site	Number of species (proportion of total)	Trap effort (camera days)	Source
Emas National Park, Brazil	16 (57%)	1035	(Silveira <i>et al.</i> , 2003)
Atlantic forest, Brazil	17 (81%)	1849	(Srbek-Araujo & Garcia, 2005)
Udzungwa Mountains, Tanzania	44 (80%)	3400	(Rovero & De Luca, 2007)
Los Amigos, Peru	21-24 (75-86%)	1440-2340	(Tobler <i>et al.</i> , 2008a)
Bakhuis Mountains, Suriname	27 (100%)	49589	J. Sanderson (in preparation)

Table 1. Efficiency of camera trapping for inventorying medium to large mammals at different sites. Camera days are defined as the number of cameras multiplied by the number of days they were functioning.

2. Guide to the use of camera traps

2.1. Camera traps: choosing the right model

The aim of this chapter is (1) to illustrate how camera traps work, and (2) to give guidelines on how to choose the appropriate camera trap for a study. With a rapidly growing number of camera trap models available on the market, choosing the right model can often be difficult. Our aim is not to recommend a specific brand or model (as these have a quick turn-over in the market), but rather to describe important criteria for choosing the proper camera trap for a particular study (Table 2). A list of additional resources is given in the Appendix 4.

2.1.1. Trigger mechanism: active and passive sensors

With the exception of active sensor models produced by TrailMaster®, commercially available camera traps use a passive sensor that detects heat-in-motion. The sensor triggers the *image recording device* (henceforth called camera, to indicate any recorder including digital ones) when something warmer than the ambient temperature passes in front of the sensor. Thus, reptiles typically elude detection because their body temperature is close to the ambient temperature.

Active sensors detect objects within a *detection zone* (or opportunity cone). The apex of the zone starts at the small sensor within the camera trap and expands outward from the camera trap in a circle. The detection zone increases with the distance from the sensor but is still much smaller in area or cross-section than the field of view of the camera. As a consequence, the position of the animal in the photo depends on the following important factors: (a) the size of the detection zone, that in turn depends on how close the camera is to the animal (see below), (b) the *trigger speed* (or latency time): the length of time between object detection by the sensor and the camera recording a picture, and (c) the speed of the passing animal.

The main advantage of the passive sensor system is that camera traps are designed as a single unit that can be very small and easy to set, whilst active sensor camera trap systems consist of two or more units (Figs 1,2). A disadvantage is that the various factors described above must be considered when setting the camera trap to ensure that the animals are centred properly in the frame, and that ground heating caused by direct sunlight creates convection waves that can trigger the sensor resulting in empty or “ghost” photographs. Thus, camera traps should not be set at spots with direct sunlight, something that may not always be easy.

An active sensor is similar to a garage door sensor and consists of two components: a transmitter and a receiver (Fig. 2). The transmitter emits a beam of light, typically red, that is detected some distance away by a second component referred to as the receiver. When the beam of light is broken by a passing animal, the detector unit triggers the camera to take a picture. Although active camera traps are employed less frequently than passive camera traps, there are some clear advantages: (1) the beam is typically very narrow so that the subject's position along the beam can be more precisely anticipated; (2) the camera can be placed independently of the sensor and detector allowing for creative photographs. Ground heating causing heat-in-motion that triggers an active sensor camera trap is not a problem for active sensor systems because the light beam remains unbroken by convection waves. However, a falling leaf can break the beam and cause the camera to record a picture (Table 2).



Fig. 1. Examples of camera-trap images; top left: a jaguar, *Panthera onca*, not centred in the frame (possibly because the animal walked too fast or the camera triggered too late); top right: a leopard *Panthera pardus* centred in the frame and holding a prey (blue duiker *Philantomba monticola*) in its mouth; bottom left: setting a camera-trap pointing to a small wildlife trail in the rainforest of Tanzania; bottom right: nocturnal photo of a bushy-tailed mongoose *Bdeogale crassicauda* taken with a Reconyx® digital camera mounting an infrared flash (photos by F. Rovero and J. Sanderson).

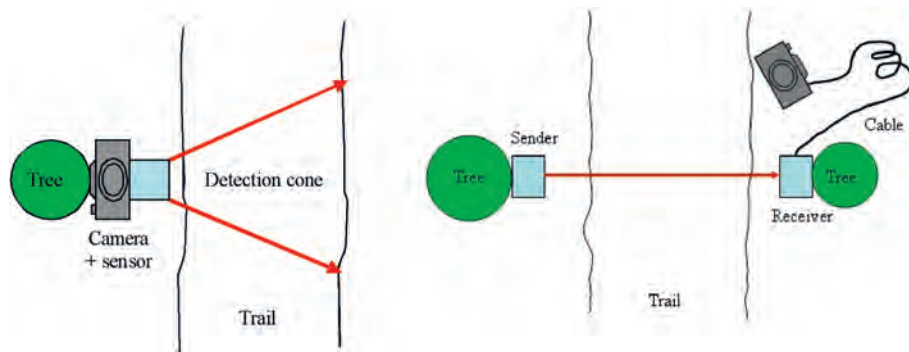

Fig. 2. Schematic figure of passive (left) and active (right) camera-trap systems.

2.1.2. Trigger speed

The trigger speed, or latency time, is the time it takes from the moment the sensor detects an object until the camera takes a photograph. Fast trigger speed is usually preferred for faunal inventories because there may be very few chances to record rare or elusive species. Camera traps set along trails require a faster trigger speed (1/2 second or even 1/10 second), because animals may pass through the frame quickly, whereas camera traps set at mineral licks, baited stations, or under fruit trees can be slower since the animal is likely to pause in front of the camera trap. Trigger speed is often slow in less expensive digital cameras, where it can exceed 2 seconds resulting in many empty photographs. However, most advanced digital cameras, such as Reconyx®, have very fast trigger speed, currently up to 1/10 second.

2.1.3. Camera trap technology: film and digital cameras

Film camera traps use a standard 35 mm film camera, and have been the standard tool used by researchers working with camera traps for the last decade. Over the last few years however, digital cameras have become more widely available, less expensive, and today only a few camera trap manufacturers still make film camera traps. In a few years digital camera traps will likely completely replace film camera traps. Despite this trend, film camera traps might not be replaced altogether so easily, because of their fast trigger speed in comparison to the currently available digital camera traps. Earlier digital camera trap models copied the design of film camera traps with a standard digital camera connected to the motion sensor. Modern digital camera traps usually consist of a camera and sensor integrated on a single board.

The biggest advantage of digital camera traps over film camera traps is that they can store thousands of images on a memory card. This means that cameras can be left in the field for a much longer period of time without the need for checking them. Also, images can be viewed immediately in the field whereas film must first

be developed. Data management is more easily achieved with digital photographs that avoid the necessity of scanning film.

Battery life varies greatly among models and, while some camera traps only last a few weeks on a set of batteries, others run for two months or more and can take thousands of photographs. Battery life decreases with the number of photographs taken and cameras with an infrared flash usually have longer battery life than models with a regular flash but are limited to black and white photographs at night. To conserve power, some digital cameras go into a sleep mode after a certain amount of time which can greatly increase the time it takes them to take the first picture. We recommend testing each camera trap in the setting it will be used before investing in a large number of them (Table 2).

Sensor system	Advantages	Disadvantages
Passive sensor	Single unit Detects animals of a wide range of sizes	Placing the animal in the centre of the frame may be difficult Triggered by heat from sunlight
Active sensor	Subject positioning is precise Heat from sunlight does not activate sensor	Made of 2 or 3 units and more complex setting and programming More expensive
Camera-trap technology	Advantages	Disadvantages
Film camera	Fast trigger speed for most models, low power requirements	Very few models are still available on the market Must be checked often as film may fill up quickly
Digital camera	Can store many photos Digital images more easy to be managed than prints	Trigger speed is slower for most models Per day power requirement is higher than for film cameras
Digital camera with infrared flash	Animals not scared by flash Much less power consumption	Night photographs are in black and white

Table 2. Advantages and disadvantages of different types of camera traps.

2.1.4. Weather-proofing

Camera traps are often deployed in the field for a long time and under harsh conditions. Thus, they must be well-sealed. There is a large difference between models, with some models being simply “rain-proof” while others are highly water-proof and resistant to humidity thanks to a tight seal using o-rings. Researchers have used silicon, tape, and other arrangements to better seal camera traps, however a well-sealed model is much preferred. Often a small

package of silica gel or other desiccant is used to absorb moisture inside the camera trap housing.

2.1.5. Cost of camera traps and critical factors to select the model

The cost of camera traps ranges from \$50 to more than \$800 depending on the model. Camera trap model choice depends on the number of units needed and the total budget. Because performance and characteristics vary between models as explained above, cost alone *should not be* the only criterion by which to choose camera traps. Less expensive camera trap models almost invariably get ruined sooner by the moisture and rain, a slow trigger speed will result in fewer photographs and greater number of animals missed, and if battery consumption is high, then the budget in battery and/or visits to the site for replacing batteries will increase.

Thus, we suggest that three variables be considered to assess cost effectiveness of camera trap models: (1) the cost of the camera traps including batteries, (2) the field costs to visit camera traps for battery/film replacement, and (3) survey duration. The use of high quality rechargeable batteries is a cost-saving strategy if the camera trapping survey is intended to run more than a few months so that the higher cost of rechargeable batteries is recovered. Similarly, if visiting the camera traps is expensive, then more expensive camera traps that generally have longer battery life will minimize the total costs. The ideal strategy to choose among various models would be to test simultaneously different camera traps set at the same sites. With a side-by-side study, and being equal the critical variables of battery life and field costs, then the metric to compare different camera trap models is purely the number of photographs obtained by each camera.

2.2. Setting cameras in the field

2.2.1. Personnel and material needed for setting up cameras

The number of people required to run a camera trap survey depends on the number of camera trap stations, the spacing between camera traps, the frequency with which camera traps are checked, and the accessibility of the stations. These factors depend on the study design (see chapter 3). Some surveys can be carried out by a team of two people while others require four to five people. Local expertise is critical to choosing the most suitable camera trap sites. Much of the work can be carried out by field assistants after careful training but we recommend that a biologist or a technician oversees the survey to manage the data and solve technical problems. Detailed planning is needed before starting field work.

For most surveys, the material needed is as follows:

- camera traps and cables to attach them on trees
- sufficient film/memory card and batteries
- hand-held GPS unit for recording camera trap locations

- data forms (camera trap setting/monitoring and description of camera trap site, see Appendices 1-3)
- flagging tape or tags for marking camera trap locations if necessary.

2.2.2. Preparing the cameras

All cameras should be prepared and tested before going to the field so that they just need to be activated in the field. Check the proper functioning of the sensor and camera by taking test pictures. Carefully inspect all seals to ensure there are no leaks. Dirt on the seal allows water to enter. Each camera trap must be uniquely numbered, or coded, for identification purposes. Write the code with a permanent marker on the housing of each camera trap. Some digital camera traps allow printing the code automatically at the bottom of each photograph. If this is not an option then taking a picture of a whiteboard showing the camera trap code with the date and time is a useful technique. For film cameras this allows identification of rolls of film from the first picture. Write the camera trap code, and start and end date on the outside of the film roll to easily track film from the field to development.

Make sure to carefully set the date and time on each camera. Re-check the date in the field when installing the camera trap. Another critical setting is the sensor sensitivity which for some passive sensor camera traps can be set too low or high. We recommend high sensitivity when working in hot climates and when small species should be photographed. For most camera trap models the time interval between consecutive photos, i.e. the time the camera waits after taking a picture until it takes another picture (the so-called *delay* time), must be chosen. Because repeated pictures of the same individual are often not useful, this setting should be sufficiently long to allow animals to move on. Times between 1 minute and 15 minutes are typically used. If camera traps can store many photos or can be checked frequently, a shorter delay time can be used.

2.2.3. Choosing a site and setting the camera

To maximize trapping success, camera traps are best set along trails. Knowledge on signs of wildlife presence and spots where animals frequently pass can be of great help when choosing camera trap locations. Camera traps are usually attached on a tree or pole at about 50 cm above ground. Once the site is selected, search for a straight tree to attach the camera trap (Fig. 1). If no suitable tree is available, a pole can be used. The tree or the position of the pole should be chosen based on the optimal distance between the camera trap and the point along the trail that will be the centre of the frame. Cameras with fast trigger speed (1/2 second or less) are usually set at about 2 m back from the trail to allow taking picture of a wide range of animals. If the trigger speed of the camera trap is slow, set the camera trap as far as 5-10 m from the trail. Note that small-bodied animals will appear very small in the frame. Camera traps are usually set perpendicular to the trail to obtain a good side image of the passing animal; however, they can also be placed slightly off perpendicular to the trail (i.e., about 60° between camera trap aim and trail) to increase the path length the subject will take through the frame. We recommend some testing with the

camera trap to determine the detection zone. This is especially easy with digital models, but even film models often have a sensor test mode (e.g. a flashing red led) that allows testing of the detection zone.

It is critically important to clean the ground in front of the camera trap of debris and vegetation that could cover the animal or reflect the flash, causing the image to be overexposed and, for some cameras, triggering the sensor thus producing series of empty images. Clearing the area will also avoid plant regeneration during the time the camera trap is deployed. As shown in fig. 3, obstacles such as branches can be used to guide the animal's path. In this figure, beside a suspected animal trail are four trees A-D. Trees A and D are too close to the trail for the camera trap. Trees B and C offer the best opportunities for good photographs. The camera trap is placed on tree B that is furthest from the trail. The camera trap sensor can still register a subject on the far right side of the trail. In places of possible risk of theft of camera traps, we suggest locking camera traps to the tree. Most models provide cables that can be locked.

A scent lure can be used to attract passing wildlife to the camera trap and position the subject in the ideal place for a photograph. This allows extra time for the camera trap to obtain a good photograph. Lure has been especially useful for carnivores (Trolle & Kery, 2005; Long *et al.*, 2007).

2.2.4. Recording information on camera setting

The exact camera trap location should be recorded using a handheld GPS unit. Also record the following information: camera trap ID number, date and time camera trap starts to operate, camera trap settings, description of the macro- and micro-habitat around the camera trap (see forms in Appendices 1-3).

2.2.5. Checking camera traps

The time interval at which camera traps are checked depends on the battery life and storage capacity of the camera trap model, the expected number of photographs as well as accessibility. Film camera traps may need to be checked as often as every one to two weeks to make sure they do not run out of film. Digital camera traps can store many more images and thus their autonomy depends on the battery life: most models can run for up to one month and those using an infrared flash can run for up to 2 months and store thousands of images. Camera traps will still need to be checked at least once every three to four weeks to detect camera traps that have been moved by animals or have some other problems. When checking camera traps the following data should be written down: number of photographs, whether film or batteries were changed, battery level as well as any observations about the camera (Appendix 2). This can help estimating average battery life and to figure out up to what date a camera trap that failed was working ok. If possible one or two spare camera traps should be taken to replace camera traps that failed. We also recommend checking the date and time setting of each camera trap each time the camera trap is visited.

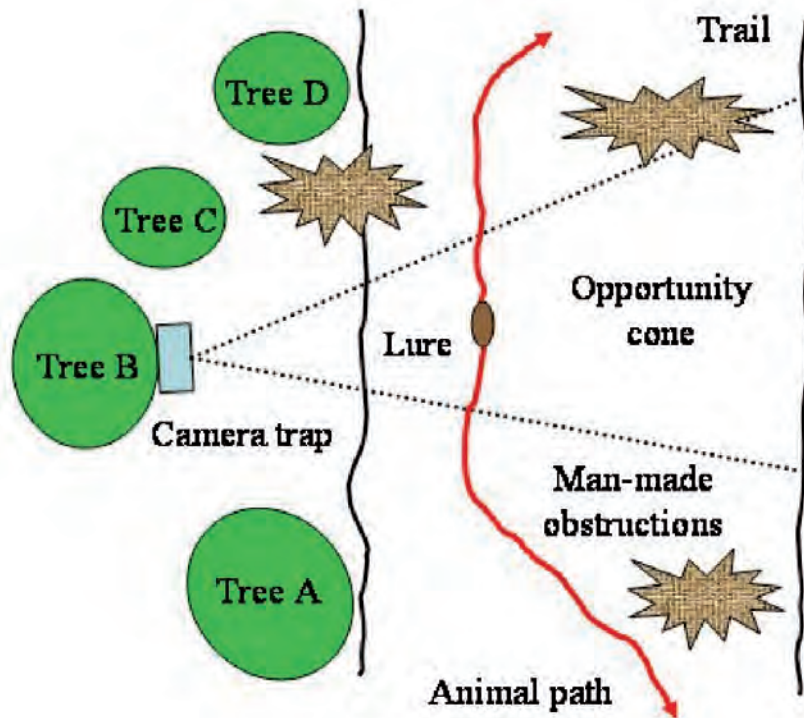

Fig. 3. Schematic drawing of camera-trap positioning, with obstacles placed to maximize the chances that the animal passes at the best distance within the detection zone, or opportunity cone, of the camera.

2.3. Data management

2.3.1. Managing photographs

Camera traps can generate a large amount of data with several thousand images being collected during a large survey. Data should be well organized during all parts of the study to avoid confusion and possibly data loss. Data analysis requires that each photograph has the following information: (1) date, (2) time, and (3) camera trap site code. While the date and time is usually printed on the photograph, only some digital camera traps allow imprinting the camera-trap code on each photograph. For other camera traps, the camera trap code must be tracked throughout the study. Hence we recommend taking a picture of a whiteboard with the camera code, date, and time when setting up the camera trap, and when the changing film or the memory card so that the first and last picture on each roll or memory card contains the proper information. We also recommend writing the code as well as the start and end date on each roll of film.

To manage photographs from film camera traps, several options are available. One option is to get contact sheets with all photographs and then only scan the photos of interests. This will reduce the number of prints required and thereby reduce costs. An alternative is to directly scan all photographs from the negatives. Many photographic laboratories can do this automatically at much lower cost than printing and it is often easier to manage a large number of photographs in digital format. If negatives are scanned, make sure each roll is placed in a different folder. The camera trap code should be entered either as part of the folder name or in a text file in each folder.

2.3.2. Managing data

While the photographs constitute the raw data, the information must be organized in a spreadsheet or database for analysis. The minimum data that must be recorded for each photograph is the code of camera trap that took it, the date and time, and the species that appears in the photograph. Additional information that can be useful is the sex and age of the animal, the number of individuals and comments on the behaviour shown.

Spreadsheet applications (*e.g.* Microsoft Excel) are still the most commonly used software for managing camera trap data. While they are simple to use, their main disadvantage is that organizing data for different analysis can be time consuming. A more flexible alternative is the use of relational databases in the form of either desktop applications (*e.g.* Microsoft Access, Filemaker) or database servers (*e.g.* MySQL, SQL Server). In most cases, the former will be easier to use since they include tools for building forms and queries but the latter might be useful when data is being used and managed by a group of people and must be stored on a central server. Database systems allow images to be linked to the data and all data to be managed in a single system.

Camera Base (<http://www.atrium-biodiversity.org/tools/camerabase/>) is free software for managing camera trap data. Camera Base is based on Microsoft Access and can manage camera trap data together with the digital images. The software has a wide range of analysis and data export options built-in, including activity patterns, capture-recapture analysis, occupancy analysis, and species accumulation and richness estimation.

3. Study designs

The sampling design appropriate for a specific study depends on many factors: objectives of the study, target species, topography and vegetation, accessibility, number of camera traps to be used, and the time available for a survey. In this section, we will discuss designs suitable for species inventories and occupancy studies. Designs for density estimates using capture-recapture methods, that are applicable to individually-recognizable species, have been discussed in details elsewhere (Karanth & Nichols, 1998; Karanth & Nichols, 2002).

3.1. Species inventory

3.1.1. Objectives

The objective of a species inventory is to obtain a complete list of all species of a certain taxonomic group found in the study area. This list will often be compared to a regional species list and the percentage of all possible species actually found in the area will be used as an indicator for the health of the ecosystem. As described in the introduction chapter, camera trapping has proven to be an efficient tool for detecting terrestrial vertebrates, in particular medium and large sized mammals, and terrestrial birds.

In many monitoring programmes, the most basic measure of interest is species diversity. Species lists however are a poor metric for monitoring large and medium sized mammals. Furthermore, looking only at diversity as an indicator will not detect changes until a species is locally extinct. Thus, methods such as occupancy analysis outlined below will be more appropriate to detect population declines at an earlier stage.

3.1.2. Survey design

For species inventories, single camera traps are set throughout the study areas. The spatial arrangement of camera traps for this study design is flexible. There are no requirements on minimum distances between camera traps or total survey area to be covered. Previous studies showed that the area covered by the camera traps has very little impact on the number of species detected (Tobler *et al.*, 2008a); inventories can therefore be conducted in a relatively small area assuming this is representative of the total study area. However, the even spacing of camera traps allows for more rigorous statistical analysis including occupancy analysis and is generally recommended for monitoring purposes. For example, the terrestrial vertebrate monitoring protocol implemented by the Tropical Ecology Assessment and Monitoring (TEAM) network recommends placing 60-90 camera traps in a grid at a distance of approximately 1.4 km from each other (i.e. one camera every 2 km²) throughout the study area (TEAM Network, 2008). A list of species expected to be found in the area and some basic knowledge on their natural history is helpful when choosing camera trap locations. The goal is to cover all habitat types of interest and to place camera traps at locations likely to be used by animals. While we recommend setting most camera traps along trails which usually are used by many species, some camera traps can also be set opportunistically targeting specific species that use water holes, mineral licks, streams, dens and fruiting trees.

Unlike surveys designed for capture-recapture analysis where the survey period must be limited to a few months to guarantee population closure, there is no time limit for camera trap inventories. For many sites, the diversity of larger species does not change over a period of a year. Researchers can therefore run a small number of camera traps over many months, or surveys can be spread out over multiple shorter periods throughout a year. Survey effort is usually measured in camera trap days, which is the number of camera traps multiplied by the number

of days they operated. In many areas many thousand camera trap days are required to obtain a fairly complete species list (Maffei *et al.*, 2002; Srbek-Araujo & Garcia, 2005; Azlan, 2006; Tobler *et al.*, 2008a); however, as shown in Table 1, efforts in the range of 1,000 to 2,000 camera trap days may be enough for detecting 60-70% of the species. The time needed to carry out a survey is inversely proportional to the number of camera traps used. When using a small number of camera traps we recommend moving camera traps every 15 to 30 days to avoid bias caused by the camera trap locations and to sample a larger area.

If surveys are repeated over years for monitoring species diversity, the same camera trap sites should be used every year, and we recommend running camera traps for approximately the same number of days every year to achieve a comparable sampling effort (TEAM Network, 2008).

3.1.3. Data analysis

Species accumulation curves have been widely used to visually assess the completeness of an inventory and to compare diversity between surveys with different sampling effort (Colwell & Coddington, 1994; Krebs, 1999; Gotelli & Colwell, 2001). They plot the cumulative number of species detected against the survey effort and reach an asymptote when all species have been recorded. Raw species accumulation curves have a stepped shape that makes it hard to detect an asymptote (Fig. 4). This problem is solved by rarefied species accumulation curves which smooth the curve by randomly re-sampling the data and calculating the average number of species expected to be found at a given sampling intensity (Gotelli & Colwell, 2001). While species accumulation curves can be used to compare diversity between different samples, the shape of the curve can vary with the relative abundance of different species (Thompson & Withers, 2003). Communities with a high proportion of abundant species have a steeper initial slope than communities with a high proportion of rare species.

In most surveys some species go undetected even though they are present in the study area. Various methods have been developed to estimate the true number of species from an incomplete survey (Soberon & Llorente, 1993; Colwell & Coddington, 1994; Colwell *et al.*, 2004). For camera trap data non-parametric estimators are usually best suited (Tobler *et al.*, 2008a;b).

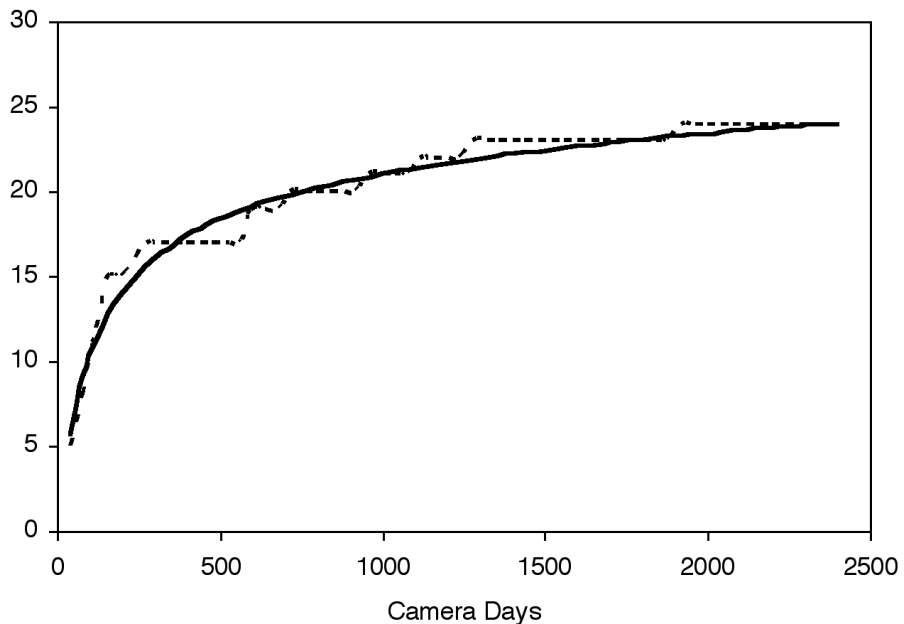

Fig. 4. Raw (dashed line) and rarefied (continuous line) species accumulation curves for camera-trap inventory data from the Peruvian Amazon.

The most commonly used estimators are the abundance-based estimators ACE and Chao 1, and the incidence-based estimators ICE, Chao 2, Jackknife 1, Jackknife 2, Jackknife 3 and Jackknife 4 (Chao, 2004). Jackknife estimators are also used to calculate the M_h model with heterogeneity in closed capture-recapture studies (Otis *et al.*, 1978; Burnham & Overton, 1979) and showed good results for camera trap data (Tobler *et al.*, 2008a). Species accumulation curves and a variety of diversity estimators can be calculated with the software EstimateS (Colwell, 2006). Diversity estimation based on the capture-recapture model M_h can also be calculated in CAPTURE (Rexstad & Burnham, 1991).

When comparing species diversity between sites based on camera trap samples, methods that account for undetected species should be used. Several methods have recently been developed to deal with this problem based on capture-recapture models and hierarchical-models (Nichols *et al.*, 1998b; Williams *et al.*, 2002; Chao *et al.*, 2005; Chao *et al.*, 2006; Kery & Royle, 2008; Royle & Dorazio, 2008). These methods give an estimate of the number of species shared by two samples and the number of species unique to one or the other sample, however they do not allow for the identification of those species.

3.1.4. Monitoring

Species diversity is concerned with the presence and absence of species and changes are defined as local extinction and colonization. Changes in diversity

are inferred by comparing species lists from different years. However, in practice detection probabilities for species are often <1 which can lead to erroneous conclusions. For example, if a species was recorded during one sampling period and was present but not recorded during a later sampling period one would falsely classify the species as extinct. On the other hand, if the species was present but not detected during the first period and was recorded during the later period one would falsely record it as a new colonization. Therefore, models that explicitly include detection probability must be used when analyzing changes in diversity over time and space. Nichols *et al.* (1998a) adapted Pollock's robust design capture-recapture model to estimate species turnover from repeated inventories. Further details on this approach can be found in Williams *et al.* (2002). Royle & Dorazio (2008) propose a hierarchical multi-species site-occupancy model to analyze temporal changes in community composition. Application of these models to analyze camera trap data is under development (T. O'Brien, personal communication), and they have great potential for data from multiple sites or multiple years.

3.2. Occupancy study

3.2.1. Objectives

Estimating abundance or density is a difficult and expensive task for many species and biologists often use some measure of relative abundance to compare between sites or to look at changes over time. For camera trap studies, the use of camera trap rates (number of photographs per camera days) is an intuitive, basic proxy for abundance but count data are often a poor index for relative abundance when detection probability is <1 (Gibbs, 2000; but see 3.3 for further discussion). One possible solution for overcoming the difficulties of estimating abundance is to use occupancy as a surrogate for abundance (MacKenzie & Nichols, 2004). Occupancy is defined as the proportion of area, patches or sites occupied by a species (MacKenzie *et al.*, 2006), and MacKenzie *et al.* (2002) developed a model to estimate site occupancy and detection probability based on repeated presence-absence surveys of multiple sites. Using occupancy as a surrogate for abundance works best for species with small ($<5 - 10 \text{ km}^2$), well defined home-ranges. In this case, one can assume that each individual can only appear in one camera trap and the camera trap grid takes a representative sample of the whole landscape. If home-ranges are large in comparison to camera trap spacing then one single individual can appear in many different camera traps and there will be little correlation between occupancy and abundance.

With the inclusion of covariates, occupancy models provide a robust statistical framework for testing many scientific hypotheses. For example, one can test for differences in occupancy rates between study sites that contrast by habitat types, hunting levels, distance to key resources, weather conditions, vegetation features. It is also possible to evaluate differences in detection probability between camera models and investigate changes in occupancy over time (O'Connell *et al.*, 2006; Linkie *et al.*, 2007; Tobler *et al.*, 2009). Occupancy models can also be expanded to combine data from different survey methods

(e.g. track stations, hair traps, live traps) and to look at occupancy at multiple spatial scales (O'Connell *et al.*, 2006; Nichols *et al.*, 2008).

3.2.2. Survey design

When carrying out an occupancy study camera traps should be set out in a regular grid with approximately equal distances between cameras. They should cover all habitat types of interest and the number of camera traps in each habitat type must be sufficiently large to allow for analysis. If possible the distance between camera traps should be larger than the diameter of the average home range of the species of interest, to avoid spatial auto-correlation. If the home-range diameter of a species is much larger than the distance between camera traps the results should be interpreted as the percentage of area used by a species during the survey period instead of the percentage of an area occupied (Tobler *et al.*, 2009).

The survey time needed largely depends on the detection probabilities of the species of interest. The higher the detection probability, the fewer survey days are needed to collect reliable data. Occupancy models assume that occupancy does not change over the survey period and, similar to capture-recapture studies, surveys should therefore be limited to two to three months. If species are known to seasonally migrate in and out of the study area surveys should be conducted outside the migration period.

Occupancy studies require a large number of camera traps to produce reliable data. Simulations showed that to increase the accuracy it is usually more efficient to increase the number of camera stations than to increase the number of survey days. This can be done by setting camera traps in multiple blocks; for example, TEAM protocol recommends deploying three consecutive blocks of 20-30 cameras, each block operating for at least 30 days (TEAM Network, 2008). If preliminary data on capture probability is available one can use the simulation capabilities of GENPRES (Hines, 2007a) or MARK (White, 2009) to estimate the optimal number of survey days and camera trap stations (Bailey *et al.*, 2007).

3.2.3. Data analysis

In this section we will focus on specific issues related to camera trap data. For details on the statistical analysis of occupancy data we refer the reader to the available literature (e.g. MacKenzie *et al.*, 2003; Royle, 2004; MacKenzie *et al.*, 2005; MacKenzie *et al.*, 2006). Two software packages are available for data analysis: PRESENCE (Hines, 2007b) and MARK (White, 2009).

Occupancy models use repeated presence/absence surveys to estimate the proportion of sites that are occupied by a species. If we assumed that we can always detect a species when it is present ($p=1$) then we could simply estimate occupancy by $\hat{\Psi} = x/s$ where x is the number of occupied sites and s the total number of sites sampled. If $p < 1$ then $\hat{\Psi} = x/s/\hat{p}$ where \hat{p} is the cumulative detection probability estimated from the data. Royle & Nichols (2003) extended this model to allow for abundance-induced heterogeneity. The idea behind the

Royle-Nichols (RN) model is that site-specific detection probabilities vary due to differences in the number of individuals present at each site, and using a mixture model these abundances can be estimated from the repeated presence-absence data. In the RN model, the occupancy Ψ is not directly estimated and has to be derived from λ , the average number of individuals at each site as $\Psi = 1 - e^{-\lambda}$. In simulations this model significantly improved occupancy estimates for data with high levels of heterogeneity (Dorazio, 2007). The RN model assumes that populations are closed and that individuals are distributed in spaces according to a Poisson process. If these assumptions are violated, the estimated parameters should not be interpreted as abundance but rather as a random effect (MacKenzie *et al.*, 2006: 141). However, occupancy estimates will still be less biased than under models that don't include heterogeneity.

The first step of data analysis consists in compiling the detection histories for each camera trap station. A detection history consists of 1 and 0 indicating whether the species was detected (photographed) during a sampling occasion or not. For example, a detection history of "01101" indicates that the species was detected during sampling occasion two, three and five. For camera trap data a sampling occasion usually consists of one or multiple consecutive days. For low detection probabilities the maximum likelihood estimator used to estimate parameters often fails to converge. For rare species it is therefore required to combine data from several days into one sampling occasion to increase detection probability. As a general indication, occupancy models will not produce any useful results for species that show up in less than 10-20% of all camera traps and have capture probabilities smaller than 0.1.

In a second step, possible covariates are selected. Covariates can be used for occupancy as well as detection probability and they should be selected based on a *a priori* hypothesis to limit the number of different models. To find the model that best fits the data, different models are compared using standard model selection procedures based on the Akaike's Information Criterion (AIC; Burnham & Anderson, 1998; MacKenzie *et al.*, 2006). We suggest comparing a single-season model with the RN model to test for heterogeneity in the data.

3.2.4. Monitoring

Occupancy models have great potential for monitoring species with small and medium-sized home-ranges. While they might not be very sensitive to small fluctuations, they can detect continuous population declines of larger fluctuations. If possible the same study design should be used every year for monitoring programmes. When analyzing multi-year data the survey year can be used as a continuous covariate to detect linear trends or as a discrete covariate to test for differences occupancy between years when occupancy is oscillating. It is also recommended to test for differences in detection probabilities among years. Model selection can be used to test if the model with time (years) as the covariate fits the data better than a model that assumes no change in occupancy over time.

3.3. Other applications

Data obtained from camera trap surveys that are principally aimed at faunal inventories may allow for other important questions to be addressed for selected species. Since each photograph includes the exact time it was taken, camera traps collect detailed data on the activity patterns of many species (van Schaik & Griffiths, 1996; Gómez *et al.*, 2005; Azlan & Sharma, 2006) and can be used to study differences in activity patterns between sympatric species (Jacomo *et al.*, 2004; Di Bitetti *et al.*, 2009; Tobler *et al.*, 2009), or changes in activity related to human impact (Di Bitetti *et al.*, 2008).

Habitat use based on camera trap data has been evaluated in different ways using Chi-square test, ANOVA and correlation coefficients (*e.g.* Moruzzi *et al.*, 2002; Augustine, 2004; Jacomo *et al.*, 2004; Di Bitetti *et al.*, 2006; Bowkett *et al.*, 2008; Di Bitetti *et al.*, 2009). Most of these studies used the number of photos or a related measure as an index and did not address the issue of detectability. Occupancy models have recently been applied for studying habitat use with camera trap data (MacKenzie *et al.*, 2005; O'Connell *et al.*, 2006; Linkie *et al.*, 2007; Tobler *et al.*, 2009). These models have the advantage that they explicitly include the detection probability allowing to differentiate between factors affecting detection probability and factors affecting occupancy probability (MacKenzie *et al.*, 2006). With an appropriate study design (see 3.2) these models allow researchers to model habitat use based on multiple variables and determine the factors that most influence the distribution of a species.

For some species, data may allow for density estimates to be derived. As mentioned above, for species with individual markings, such as most felids, density estimation can be derived using capture-recapture analysis (Karanth & Nichols, 1998). Rowcliffe *et al.* (2008) proposed a method to estimate density without the need for individual recognition, based on modelling the contacts between cameras and animals. This method requires parameters such as speed of movement or day range that may not be available for most wild animals. As an alternative method, camera trap rates can be used as a surrogate for abundance for species that cannot be identified from images. A recent study on rainforest ungulates shows the validity and usefulness of this index (Rovero & Marshall, 2009). The relationship between trap rate and true abundance must be assessed through calibration with independently-derived density estimates (O'Brien *et al.*, 2003; Rovero & Marshall, 2009), making this index of less simple use than it may seem. Calibration should ideally be re-assessed periodically and when comparing camera trap rates across contrasting sites (O'Brien, in press).

4. Recommended references

AUGUSTINE, D.J. 2004. Influence of cattle management on habitat selection by impala on central Kenyan rangeland. *Journal of Wildlife Management* 68: 916-923.

AZLAN, J.M. 2006. Mammal diversity and conservation in a secondary forest in Peninsular Malaysia. *Biodiversity and Conservation* 15: 1013-1025.

- AZLAN, J.M. & SHARMA, D.S.K. 2006. The diversity and activity patterns of wild felids in a secondary forest in Peninsular Malaysia. *Oryx* 40: 36-41.
- BAILEY, L.L., HINES, J.E., NICHOLS, J.D. & MACKENZIE, D.I. 2007. Sampling design trade-offs in occupancy studies with imperfect detection: examples and software. *Ecological Applications* 17: 281-290.
- BOWKETT, A.E., ROVERO, F. & MARSHALL, A.R. 2008. The use of camera-trap data to model habitat use by antelope species in the Udzungwa Mountain forests, Tanzania. *African Journal of Ecology* 46: 479-487.
- BURNHAM, K.P. & ANDERSON, D.R. 1998. Model Selection and Inference: A Practical Information-Theoretic Approach. Springer, New York: xix, 353 pp.
- BURNHAM, K.P. & OVERTON, W.S. 1979. Robust estimation of population-size when capture probabilities vary among animals. *Ecology*, 60: 927-936.
- CHAO, A. 2004. Species richness estimation. In: Balakrishnan N., Read C.B. & Vidakovic B. (Eds). *Encyclopedia of Statistical Sciences*, Wiley, New York: 7909-7916.
- CHAO, A., CHAZDON, R.L., COLWELL, R.K. & SHEN, T.J. 2005. A new statistical approach for assessing similarity of species composition with incidence and abundance data. *Ecology Letters* 8: 148-159.
- CHAO, A., CHAZDON, R.L., COLWELL, R.K. & SHEN, T.J. 2006. Abundance-based similarity indices and their estimation when there are unseen species in samples. *Biometrics* 62: 361-371.
- COLWELL, R.K. 2006. EstimateS: Statistical estimation of species richness and shared species from samples. Version 8.0. <http://purl.oclc.org/estimates>
- COLWELL, R.K. & CODDINGTON, J.A. 1994. Estimating terrestrial biodiversity through extrapolation. *Philosophical Transactions of the Royal Society of London Series B: Biological Sciences* 345: 101-118.
- COLWELL, R.K., MAO, C.X. & CHANG, J. 2004. Interpolating, extrapolating, and comparing incidence-based species accumulation curves. *Ecology* 85: 2717-2727.
- DI BITETTI, M.S., DI BLANCO, Y.E., PEREIRA, J.A., PAVIOLO, A. & PEREZ, I.J. 2009. Time partitioning favors the coexistence of sympatric crab-eating foxes (*Cerdocyon thous*) and pampas foxes (*Lycalopex gymnocercus*). *Journal of Mammalogy* 90: 479-490.
- DI BITETTI, M.S., PAVIOLO, A. & DE ANGELO, C. 2006. Density, habitat use and activity patterns of ocelots (*Leopardus pardalis*) in the Atlantic Forest of Misiones, Argentina. *Journal of Zoology* 270: 153-163.
- DI BITETTI, M.S., PAVIOLO, A., FERRARI, C.A., DE ANGELO, C. & DI BLANCO, Y. 2008. Differential responses to hunting in two sympatric species of brocket deer (*Mazama americana* and *M-Nana*). *Biotropica* 40: 636-645.
- DORAZIO, R.M. 2007. On the choice of statistical models for estimating occurrence and extinction from animal surveys. *Ecology* 88: 2773-2782.

- GIBBS, J.P. 2000. Monitoring populations. *In*: L. Boitani & T.K. Fuller (Eds). *Research Techniques in Animal Ecology: Controversies and Consequences*. Columbia University Press, New York: 213-252.
- GÓMEZ, H., WALLACE, R.B., AYALA, G. & TEJADA, R. 2005. Dry season activity periods of some Amazonian mammals. *Studies on Neotropical Fauna and Environment* 40: 91-95.
- GOTELLI, N.J. & COLWELL, R.K. 2001. Quantifying biodiversity: procedures and pitfalls in the measurement and comparison of species richness. *Ecology Letters* 4: 379-391.
- GRIFFITHS, M. & VAN SCHAİK, C.P. 1993. Camera-trapping: a new tool for the study of elusive rain forest animals. *Tropical Biodiversity* 1: 131-135.
- HINES, J.E. 2007a. GENPRES. USGS-PWRC.
<http://www.mbr-pwrc.usgs.gov/software/presence.html>
- HINES, J.E. 2007b. PRESENE 2.1 - Software to estimate patch occupancy and related parameters. USGS-PWRC.
<http://www.mbr-pwrc.usgs.gov/software/presence.html>
- JACKSON, R.M., ROE, J.D., WANGCHUK, R. & HUNTER, D.O. 2006. Estimating snow leopard population abundance using photography and capture-recapture techniques. *Wildlife Society Bulletin* 34: 772-781.
- JACOMO, A., SILVEIRA, L. & DINIZ, J.A.F. 2004. Niche separation between the maned wolf (*Chrysocyon brachyurus*), the crab-eating fox (*Dusicyon thous*) and the hoary fox (*Dusicyon vetulus*) in central Brazil. *Journal of Zoology*, 262: 99-106.
- KARANTA, K.U. & NICHOLS, J.D. 2002. *Monitoring tigers and their prey: a manual for researchers, managers, and conservationists in tropical Asia*. Centre for Wildlife Studies, Bangalore, India: xv, 193 pp.
- KARANTH, K.U. & NICHOLS, J.D. 1998. Estimation of tiger densities in India using photographic captures and recaptures. *Ecology* 79: 2852-2862.
- KERY, M. & ROYLE, J.A. 2008. Hierarchical Bayes estimation of species richness and occupancy in spatially replicated surveys. *Journal of Applied Ecology* 45: 589-598.
- KREBS, C.J. 1999. *Ecological methodology*, 2nd edition. Benjamin/Cummings, Menlo Park, California: xii, 620 pp.
- LARRUCEA, E.S., SERRA, G., JAEGER, M.N. & BARRETT, R.H. 2007. Censusing bobcats using remote cameras. *Western North American Naturalist* 67: 538-548.
- LINKIE, M., DINATA, Y., NUGROHO, A. & HAIDIR, I.A. 2007. Estimating occupancy of a data deficient mammalian species living in tropical rainforests: sun bears in the Kerinci Seblat region, Sumatra. *Biological Conservation* 137: 20-27.
- LONG, R.A., DONOVAN, T.M., MACKAY, P., ZIELINSKI, W.J. & BUZAS, J.S. 2007. Comparing scat detection dogs, cameras, and hair snares for surveying carnivores. *Journal of Wildlife Management* 71: 2018-2025.

- MACKENZIE, D.I. & NICHOLS, J.D. 2004. Occupancy as a surrogate for abundance estimation. *Animal Biodiversity and Conservation* 27: 461–467.
- MACKENZIE, D.I., NICHOLS, J.D., HINES, J.E., KNUTSON, M.G. & FRANKLIN, A.B. 2003. Estimating site occupancy, colonization, and local extinction when a species is detected imperfectly. *Ecology* 84: 2200–2207.
- MACKENZIE, D.I., NICHOLS, J.D., LACHMAN, G.B., DROEGE, S., ROYLE, J.A. & LANGTIMM, C.A. 2002. Estimating site occupancy rates when detection probabilities are less than one. *Ecology* 83: 2248–2255.
- MACKENZIE, D.I., NICHOLS, J.D., ROYLE, J.A., POLLOCK, K.H., BAILEY, L.L. & HINES, J.E. 2006. *Occupancy Estimation and Modeling: Inferring Patterns and Dynamics of Species Occurrence*. Elsevier, Amsterdam: xviii, 324 pp.
- MACKENZIE, D.I., NICHOLS, J.D., SUTTON, N., KAWANISHI, K. & BAILEY, L.L. 2005. Improving inferences in population studies of rare species that are detected imperfectly. *Ecology* 86: 1101–1113.
- MAFFEI, L., CUÉLLAR, E. & NOSS, A.J. 2002. Uso de trampas-cámara para la evaluación de mamíferos en el ecotono Chaco-Chiquitania. *Revista Boliviana de Ecología y Conservación* 11: 55–65.
- MORUZZI, T.L., FULLER, T.K., DEGRAAF, R.M., BROOKS, R.T. & LI, W.J. 2002. Assessing remotely triggered cameras for surveying carnivore distribution. *Wildlife Society Bulletin* 30: 380–386.
- NICHOLS, J.D., BAILEY, L.L., O'CONNELL, A.F., TALANCY, N.W., GRANT, E.H.C., GILBERT, A.T., ANNAND, E.M., HUSBAND, T.P. & HINES, J.E. 2008. Multi-scale occupancy estimation and modelling using multiple detection methods. *Journal of Applied Ecology* 45: 1321–1329.
- NICHOLS, J.D., BOULINIER, T., HINES, J.E., POLLOCK, K.H. & SAUER, J.R. 1998a. Estimating rates of local species extinction, colonization, and turnover in animal communities. *Ecological Applications* 8: 1213–1225.
- NICHOLS, J.D., BOULINIER, T., HINES, J.E., POLLOCK, K.H. & SAUER, J.R. 1998b. Inference methods for spatial variation in species richness and community composition when not all species are detected. *Conservation Biology* 12: 1390–1398.
- O'BRIEN, T.G. in press. Abundance, density and relative abundance: conceptual framework. In: O'Connell A.F., Nichols J.D. & Karanth U.K. (Eds). *Camera Traps in Animal Ecology: Methods and Analyses*. Springer, New York.
- O'BRIEN, T.G., KINNAIRD, M.F. & WIBISONO, H.T. 2003. Crouching tigers, hidden prey: Sumatran tiger and prey populations in a tropical forest landscape. *Animal Conservation* 6: 131–139.
- O'CONNELL, A.F., NICHOLS, J.D. & KARANTH, U.K. in press. *Camera Traps in Animal Ecology: Methods and Analyses*. Springer, New York.
- O'CONNELL, A.F., TALANCY, N.W., BAILEY, L.L., SAUER, J.R., COOK, R. & GILBERT, A.T. 2006. Estimating site occupancy and detection probability parameters for

- meso- and large mammals in a coastal ecosystem. *Journal of Wildlife Management* 70: 1625-1633.
- OLIVEIRA-SANTOS, L.G.R., TORTATO, M.A. & GRAIPEL, M.E. 2008. Activity pattern of Atlantic Forest small arboreal mammals as revealed by camera traps. *Journal of Tropical Ecology* 24: 563-567.
- OTIS, D.L., BURNHAM, K.P., WHITE, G.C. & ANDERSON, D.R. 1978. Statistical inference from capture data on closed animal populations. *Wildlife Monograph* 62.
- REXSTAD, E. & BURNHAM, K.P. 1991. *User's guide for interactive program CAPTURE. Abundance estimation of closed animal populations*. Colorado State University, Fort Collins.
- ROVERO, F. & DE LUCA, D.W. 2007. Checklist of mammals of the Udzungwa mountains of Tanzania. *Mammalia* 71: 47-55.
- ROVERO, F., JONES, T. & SANDERSON, J. 2005. Notes on Abbott's duiker (*Cephalophus spadix* True 1890) and other forest antelopes of Mwanihana Forest, Udzungwa Mountains, Tanzania, as revealed by camera-trapping and direct observations. *Tropical Zoology*, 18: 13-23.
- ROVERO, F. & MARSHALL, A.R. 2009. Camera trapping photographic rate as an index of density in forest ungulates. *Journal of Applied Ecology* 46: 1011-1017.
- ROVERO, F., RATHBUN, G.B., PERKIN, A., JONES, T., RIBBLE, D.O., LEONARD, C., MWAKISOMA, R.R. & DOGGART, N. 2008. A new species of giant sengi or elephant-shrew (genus *Rhynchocyon*) highlights the exceptional biodiversity of the Udzungwa Mountains of Tanzania. *Journal of Zoology* 274: 126-133.
- ROWCLIFFE, J.M. & CARBONE, C. 2008. Surveys using camera traps: are we looking to a brighter future? *Animal Conservation* 11: 185-186.
- ROYLE, J.A. 2004. N-mixture models for estimating population size from spatially replicated counts. *Biometrics* 60: 108-115.
- ROYLE, J.A. & DORAZIO, R.M. 2008. *Hierarchical modeling and inference in ecology: the analysis of data from populations, metapopulations and communities*. 1st edition, Academic Press, London: 444 pp.
- ROYLE, J.A. & NICHOLS, J.D. 2003. Estimating abundance from repeated presence-absence data or point counts. *Ecology* 84: 777-790.
- SANDERSON, J. G. 2007. No mean cat feat. *Science* 317: 1151.
- SANDERSON, J.G. & TROLLE, M. 2005. Monitoring elusive mammals. *American Scientist* 93: 148-156.
- SEYDACK, A.H.W. 1984. Applications of photo-recording devices in the census of larger rainforest mammals. *South African Journal of Wildlife Research* 14: 10-14.
- SHIRAS, G.I. 1913. Nature's transformation at Panama. *The National Geographic Magazine* 8: 159-194.

- SILVEIRA, L., JACOMO, A.T.A. & DINIZ, J.A.F. 2003. Camera trap, line transect census and track surveys: a comparative evaluation. *Biological Conservation* 114: 351-355.
- SOBERON, J. & LLORENTE, J. 1993. The use of species accumulation functions for the prediction of species richness. *Conservation Biology* 7: 480-488.
- SRBEK-ARAUJO, A.C. & GARCIA, A.C. 2005. Is camera-trapping an efficient method for surveying mammals in Neotropical forests? A case study in south-eastern Brazil. *Journal of Tropical Ecology* 21: 1-5.
- TEAM Network 2008. *Terrestrial vertebrate protocol implementation manual*, v. 3.0. Tropical Ecology, Assessment and Monitoring Network, Center for Applied Biodiversity Science, Conservation International, Washington DC: 56 pp.
- THOMPSON, G.G. & WITHERS, P.C. 2003. Effect of species richness and relative abundance on the shape of the species accumulation curve. *Austral Ecology* 28: 355-360.
- TOBLER, M.W., CARRILLO-PERCASTEGUI, S.E., PITMAN, R.L., MARES, R. & POWELL, G. 2008a. An evaluation of camera traps for inventorying large- and medium-sized terrestrial rainforest mammals. *Animal Conservation* 11: 169-178.
- TOBLER, M.W., CARRILLO-PERCASTEGUI, S.E., PITMAN, R.L., MARES, R. & POWELL, G. 2008b. Further notes on the analysis of mammal inventory data collected with camera traps. *Animal Conservation* 11: 187-189.
- TOBLER, M.W., CARRILLO-PERCASTEGUI, S.E. & POWELL, G. 2009. Habitat use, activity patterns and use of mineral licks by five species of ungulate in south-eastern Peru. *Journal of Tropical Ecology* 25: 261-270.
- TROLLE, M. & KERY, M. 2005. Camera-trap study of ocelot and other secretive mammals in the northern Pantanal. *Mammalia* 69: 409-416.
- VAN SCHAIK, C.P. & GRIFFITHS, M. 1996. Activity periods of Indonesian rain forest mammals. *Biotropica* 28: 105-112.
- WHITE, G.C. 2009. MARK - Mark and Recapture Parameter Estimation. Colorado State University. <http://welcome.warnercnr.colostate.edu/~gwhite/mark/mark.htm>
- WILLIAMS, B.K., NICHOLS, J.D. & CONROY, M.J. 2002. *Analysis and management of animal populations: modeling, estimation, and decision making*. Academic Press, San Diego: xvii, 817 pp.
- YUFEN, Y., DRUBGYAL, ACHU, ZHI, L. & SANDERSON, J. 2007. First photographs in nature of the Chinese mountain cat. *Cat News* 47: 6-7.

5. Appendices

Appendix 1. Camera-trap deployment form

Camera ID code	Camera position (Lat/long)	Start year, day, time	Notes	Recorder name

Appendix 2. Camera-trap monitoring form

Camera ID code	Year, day, time	Film Changed	Battery Changed	Number of photos taken	Notes	Recorder name
		<input type="checkbox"/>	<input type="checkbox"/>			
		<input type="checkbox"/>	<input type="checkbox"/>			
		<input type="checkbox"/>	<input type="checkbox"/>			
		<input type="checkbox"/>	<input type="checkbox"/>			
		<input type="checkbox"/>	<input type="checkbox"/>			
		<input type="checkbox"/>	<input type="checkbox"/>			
		<input type="checkbox"/>	<input type="checkbox"/>			
		<input type="checkbox"/>	<input type="checkbox"/>			

Appendix 3. Camera-trap site habitat description form

Study site..... Date.....
Data collector.....

Camera ID number..... Nearest cameras and approx distance.....

Altitude (m a.s.l.)..... Slope (deg.).....

Distance to nearest village/park boundary.....

Camera placed on: large trail small trail Other.....

Bait used: Any signs/dungs already in site.....

Gross habitat: lowland forest submontane forest montane forest swamp
regenerating forest riverine plantation woodland bamboo grassland
cultivation

Other habitat.....

Canopy cover (for forest habitats): closed canopy regenerating shrubby
open

Floor cover: shrub/thickets > 2m height < 2m seedlings grass leaf litter
rock

Cover density dense moderately dense open

Dominant tree species.....

Dominant understorey species.....

Any further relevant description (e.g. more details on
microhabitat).....
.....

Appendix 4. Useful web-sites

<http://www.atrium-biodiversity.org/tools/camerabase/>

Camera Base, a free software for managing camera-trap data.

<http://www.teamnet.work.org/en/protocols/bio/terrestrial-vertebrate/>

Terrestrial vertebrate monitoring protocol adopted by TEAM (Tropical Ecology, Assessment and Monitoring Network).

<http://uk.groups.yahoo.com/group/cameratraps/>

Camera-trap email discussion group.

<http://www.trailcampro.com/>

Detailed reviews, comparisons and technical details on various digital models

<http://www.chasingame.com/>

Detailed reviews on many different digital camera-trap models.

A selection of camera-trap producers' web-sites:

<http://www.reconyx.com/>

<http://www.trailmaster.com/>

<http://www.snapshotsniper.com/>

<http://www.camtrakker.com/>

<http://www.huntingcamonline.com/>

<http://www.cuddeback.com/>

<http://www.stealthcam.net/>

Chapter 7

Organizing specimen and tissue preservation in the field for subsequent molecular analyses

by

Birgit Gemeinholzer

Botanic Garden and Botanical Museum Berlin-Dahlem (Freie Universität Berlin)
Königin-Luise-Straße 6-8, 14195 Berlin, Germany
Email: b.gemeinholzer@bgbm.org

Isabel Rey

Museo Nacional de Ciencias Naturales (CSIC)
C/ José Gutiérrez Abascal 2, 28006 Madrid, Spain
Email: mcnrf3g@mncn.csic.es

Kurt Weising

Plant Molecular Systematics, Department of Sciences
University of Kassel, Heinrich-Plett-Str. 40, 34132 Kassel, Germany
Email: weising@uni-kassel.de

Michael Grundmann

Natural History Museum, Department of Botany
London SW7 5BD, U.K.
Email: m.grundmann@nhm.ac.uk

Alexandra N. Muellner

Biodiversität und Klima Forschungszentrum (BiK-F) & Goethe University
Senckenberganlage 25, 60325 Frankfurt am Main, Germany
Email: alexandra.muellner@senckenberg.de

Holger Zetsche

Botanic Garden and Botanical Museum Berlin-Dahlem (Freie Universität Berlin)
Königin-Luise-Straße 6-8, 14195 Berlin, Germany
Email: h.zetsche@bgbm.org

Gabriele Droege

Botanic Garden and Botanical Museum Berlin-Dahlem (Freie Universität Berlin)
Königin-Luise-Straße 6-8, 14195 Berlin, Germany
Email: g.droege@bgbm.org

Ole Seberg

Botanical Garden and Museum, Natural History Museum of Denmark
Sølvgade 83, Opg. S.DK-1307 Copenhagen, Denmark
Email: oles@snm.ku.dk

Gitte Petersen

Botanical Garden and Museum, Natural History Museum of Denmark
Sølvgade 83, Opg. S.DK-1307 Copenhagen, Denmark
Email: gittep@snm.ku.dk

David Rawson

LIRANS Institute of Research in the Applied Natural Sciences
University of Bedfordshire, 250 Butterfield, Great Marlings, Luton, Bedfordshire
LU2 8DL, U.K.
Email: David.Rawson@beds.ac.uk

Lee Weigt

Smithsonian Institution
Washington, DC, USA
Email: weigt@si.edu

Abstract

During the last decades DNA-based methods have revolutionized almost all areas of biological research. While DNA isolation techniques are continuously being improved, the impact and importance of adequate pre-DNA-isolation treatment are still largely underestimated. In the present review, we present some guidelines on how to organize specimen and tissue preservation in the field for optimized subsequent molecular analyses. Recommendations are given on how to set up a collection plan and sampling strategy, how to gather information on the environment, habitat and taxa to be collected, and how to deal with legal issues. Furthermore, we review currently used field tissue storage methods and their efficiency for different types of samples and organisms, taking into account the available resources and the intended use of the sampled material. We also make suggestions about logistics, precautions, and safety as well as on how to carry out field-work and how to prevent contamination. When collecting specimens (vouchers) and parts of specimens (DNA, tissue) both the short-term and long-term preservation of the samples and their subsequent storage in natural history collections must be guaranteed. Checklists of documentation essentials and equipment for collection trips are appended.

Key words: DNA, collection, silica gel, documentation, storage

1. Introduction

During the last decade, DNA-based analyses have radically influenced nearly all areas of biological research and most strongly influenced our understanding of evolutionary mechanisms, population dynamics, phylogenetic relationships, and systematics. While DNA isolation techniques are continuously being improved and standardized during the past few years, related protocols of voucher compilation, issues of documentation and tissue collection prior to DNA isolation have widely been neglected. The aim of the present chapter is to give some guidelines for streamlining, optimizing and standardizing pre-DNA treatments of sampled specimens.

Streamlining will become increasingly important, as DNA-based analyses have not only become an essential part of fundamental research but also hold the potential for fast, standardized and cheap species identification and comparison for rapid biodiversity assessments.

Even conservative guesstimates stress that the vast majority of the Earth's biodiversity is still unknown and undescribed. Knowledge of species diversity and sufficient capacity for its rapid assessment are crucial for tackling numerous research questions, including the impact of global change and conservation considerations. It has often been postulated that global warming will lead to massive waves of species declines and extinctions. Yet, for the most diverse groups of organisms the extent of such changes will remain speculative as no baseline data on current diversity are available. The importance of species diversity for ecosystem services and function may be paramount but at present can only be addressed for a restricted set of model organisms, or by subsuming several species as "functional groups". In evolutionary biology, patterns and mechanisms of species-rich adaptive radiations will only be understood once complete inventories of the radiations have been made. However, our knowledge about the true extent of biodiversity will stay fragmentary unless traditional methods for organism identification and description are complemented by more sophisticated techniques to allow increased speed and capacity.

To help accelerate and standardize species inventories by means of mechanical or electronic systems, new methods like DNA barcoding, DNA taxonomy, and e-taxonomy have been proposed. DNA barcoding, first suggested by Hebert *et al.* (2003) involves the comparison of a short pre-defined stretch of the DNA of unknown organisms to a database of sequences from the same DNA region from verified reference specimens for identification (for recent reviews see Hajibabaei *et al.*, 2007; Valentini *et al.*, 2009; Fazekas *et al.*, 2009; Chase & Fay, 2009; for plants, see also CBOL Plant Working Group, 2009). The method allows for fast, cheap, standardized, automated species identification and has the potential to flag new and undescribed species. Attempts to establish DNA barcoding for all organisms on a highly coordinated world-wide scale are in progress (*e.g.*, CBOL (<http://www.barcoding.si.edu/>), BOLD (<http://www.barcodinglife.org/>)). Once the techniques are firmly established and become a routine application, they will assist and greatly accelerate biodiversity assessments and species inventories. However, standardized procedures are required.

Historical background

First protocols for plant DNA isolation from small tissue samples became established in the 1980s (*e.g.*, Dellaporta *et al.*, 1983; Rogers & Bendich, 1985; Doyle & Doyle 1990) and have been improved since for different groups of organisms and numerous applications. By now, hundreds of DNA isolation protocols can be found in the literature, many of which merely represent slight modifications of existing standard procedures (see Weising *et al.*, 2005 for an extensive survey of plant DNA extraction methods). Furthermore, various commercial DNA isolation kits are now on the market and manufacturers proclaim rapid and efficient isolation of genomic DNA with high yield. However, the impact of adequate pre-DNA-isolation treatment is most often underestimated; even though the state of knowledge has progressed in this area. For example, we know now that treating the sampled tissues with certain fixatives (*e.g.* alcohol, formalin) or poisons (*e.g.* mercurichloride, arsenic) can greatly decrease the success rates of subsequent molecular studies, while novel DNA-protecting/preserving measures are available that make use of, *e.g.*, inert beads and trehalose. Furthermore, next-generation sequencing technologies enable us to perform "environmental" or mixed-sample sequencing, with a strong impact on current collection strategies, but not always for the global good (some "second-generation" procedures are tolerant of sheared or small DNA fragments).

For earlier work on specimen collection and tissue preservation strategies for molecular projects and biorepository issues, the reader should also refer to the excellent reviews of Dessauer & Hafner (1984), Simione (1992), Guarino *et al.* (1995), Dessauer *et al.* (1996), Prendini *et al.* (2002), Hanner & Gregory (2007) and ISBER (2008).

2. Before you go - pre-expedition preparations

Before embarking on a collection trip one has to

- set up an adequate collection plan/sampling strategy and organize the logistics
- gather ample information on the environment, habitat and taxa to be collected from the literature and other sources
- find out if collection permits are required (also consider permits for transport, export and import) and obtain permit(s) (see *e.g.* Convention on Biological Diversity, www.cbd.int; Anonymous, 2002 and CITES, www.cites.org). Each country may have its own legislation!
- determine and test the most suitable field tissue storage method for the samples. "Optimal" and "best" is not always the same (*e.g.* in remote areas with limited labour liquid nitrogen tanks are not feasible)
- prepare your collecting protocol

2.1. Collection plan/Sampling strategy

The optimal strategy to collect biological specimens for molecular analyses is mainly determined by the aims of the particular project. However, the decision of how many individuals and populations should ideally be sampled also depends on logistical issues such as financial support, team size, and the locally available resources. The optimal sampling strategy is often a compromise between scientific needs and financial constraints. Nature conservation issues may become a limiting factor as well. To reduce possible negative impacts on any wild plant, animal or fungal populations, sampling designs should be clearly defined and analysed prior to field collecting.

The ideal scenario to capture the maximum genetic diversity of a species under investigation would include sampling of as many individuals as possible over an area as wide as possible, without endangering the species or population (Groves 2003; Neel & Cummings 2003). For reasons outlined above, this is most often not possible or even desirable, especially as the molecular technique to be used will often limit the amount of genetic screening that is possible. Nevertheless, more than one individual per taxon should definitely be sampled even for phylogenetic studies, because a single individual does not represent the genetic diversity of a species or population (though it is preferable to none for some studies). Genetic diversity depends on inherent aspects, such as breeding system and population size, but it is also conditioned by biotic and abiotic factors of the environment. The differences in environmental conditions at different geographic locations are likely to impose different selection pressures on populations and thereby promote genetic differentiation. The availability of only a single individual per taxon will also limit the opportunities to discover problems associated with misidentifications, cryptic species, or related issues.

Recommendations given in the literature on how to collect plant genetic resources mainly deal with crop species and their wild relatives (*e.g.*, Marshall & Brown 1975; Guarino *et al.*, 1995; Singh *et al.*, 2006). For population level analyses, Marshall & Brown (1975) proposed the capture of at least one copy of 95% of all alleles that occur at frequencies greater than 5% in the target population. To achieve this, the authors estimated that the minimum number of randomly chosen individuals per population to be sampled should be 30 (outbreeders) or 59 (inbreeders) while the Center for Plant Conservation in the USA recommends the sampling of between 10-50 plants per population (Falk & Holsinger, 1991). Singh *et al.* (2006) stressed that between 5 and 12 samples for some wild wheat species would be needed to obtain a standard error equal to 10% of the diversity in the population of the species. However, the exact value depends on the species. So far, published recommendations are based on the investigations of only a few species and no generalities can be proposed. Knowledge is especially scarce in tropical regions, where data about animal or plant population structure are rarely available!

To capture the genetic diversity within a species, the more information that collectors have at hand, the better is their decision-making with regard to sampling. However, collectors are increasingly working against a background of rapid population loss and relatively meagre resources. Therefore, in the absence

of better advice, a good start would be to sample individuals from five populations from across the geographical range of the taxon (see Falk & Holsinger, 1991). Obviously, the fewer individuals or populations sampled, the less genetic diversity is likely to be captured. Selection of individuals or populations to be collected should follow economic (distance from base, and time for collection) as well as eco-geographical criteria. In essence, there is no problem in collecting within a population until an obvious barrier to genetic exchange (likely to lead to genetic isolation) is encountered. It would then be advisable to keep samples from either side of this barrier separate. However, care should be taken in regions where past barriers, e.g. glaciation, can easily be overlooked. This could lead to an underestimation of the present-day genetic diversity, when only one population from a restricted area is collected. One has also to consider that some species occur in fragmented habitats, like forests (at least in Europe), rivers, moors etc. In plants, the nature of barriers will depend on the pollen and fruit/seed dispersal strategy of the species - in animals it is dependent on means of migration and availability of past and extant migration routes. Most of the dispersal will usually be local. As a practical approach, and when there is insufficient information on dispersal of the targeted species, the boundary between two adjacent populations could be arbitrarily established as the absence of individuals between them over a certain distance. However, one has to keep in mind that there will be considerable differences between species in this respect. With sufficient sampling and geo-referencing of all samples, the data can help to determine, post-facto, where interesting groupings occur, and thereby help to direct future sampling efforts.

Collectors also need to gather information on other biological characteristics of the targeted species. In some cases knowledge may already exist about intraspecific morphological variation, breeding system, ecological specialisation and distribution patterns, and assumptions can then be made about patterns of gene flow and the numbers of individuals and populations that should be sampled. For instance, outcrossing, wind-pollinated woody perennial plant species usually have a high proportion of their gene diversity within populations. Consequently, fewer populations may have to be sampled from these species as compared with, e.g., selfing annuals where a high proportion of the total gene diversity is usually found between populations (Hamrick *et al.*, 1995). Similarly, highly fragmented distribution patterns are often indicators for high levels of genetic differentiation between the isolated populations. In general, one should always attempt to collect the broad diversity of a species or population. For large populations in a uniform landscape, it may be advisable to sample at regular intervals along transects.

Before embarking on a field trip, a **collecting protocol** should be set up to ensure that all collectors or collector teams will sample with comparable efforts, independent of time and location. This becomes critically important if collection efforts and/or occurrence data need to be quantified. The data should be recorded in a way that is as objective as possible and will be easy to comprehend several decades from now. Full documentation allowing for verification and re-sampling of the material is a crucial requirement for any collection (for examples see Table 1).

Working protocols must include the locality – this is the singular most important information, without it any other information is of lesser value. Protocols should also include columns for taxon-specific information (see also chapters on taxa oriented methods further in this manual), for DNA data that will be entered at a later stage (see Table 1), and for other kinds of annotations. In some cases (especially in tropical countries) it may be necessary to collect duplicate vouchers because local authorities may request one set of specimens to be kept in the country of origin.

In summary:

- Before planning a collection trip one should bear in mind the questions being asked, the budget that is available for the project, the rarity of the species to be collected, and the ease/likelihood of future collecting opportunities.
- A well-defined sampling strategy has to be set up prior to the collection trip. Most importantly, it must be estimated how many populations/individuals need to be sampled to capture the inherent genetic diversity. In addition, the ultimate uses of the samples beyond the immediate project aim need to be considered. Not all specimens collected need to be analyzed immediately, but an important factor is the cost associated with long-term storage.
- A collection protocol needs to be established prior to going into the field and changes need to be annotated as necessary.

Data	Example	Comments	Obligatory
Name of Expedition	"Greece, Kykades 14.- 20.6.2009"		Yes
Country	"Canada"		Yes
Date	"15.10.2000"		Yes
Coordinates	"40° 22' 5"N 44° 2' 49"E"	as precise as possible	Yes
Location	"Vayots Dzor province, mainroad to south Armenia, W of Yeghegnadzor, SE of crossroad to Erechgnadzor"		Yes
Location description	"slope S of river", "pine forest", "fresh water lake"	precise information is helpful	Yes
Altitude	"1050 m s.m."	sometimes GPS is not very accurate - indicate this	Yes
Collector/ collection team	"Ch. Brown"	indicate if you collected in a team	Yes
Collection strategy	"Plot sampling of 12 individuals per population", "transect along an east-west"	be as precise as possible	Yes

	gradient of xxx km/miles", "all catches of trap 10 between 11-12 pm on 6 th of June 2009",		
Tissue ID	B GT 0003256	One unique identifier or code for each individual tissue. For population samples combine a unique identifier of the locality with one of the taxon	Yes
Tissue type	"Leaf", "Root", "Seed", "Leg", "Toe", "Blood"	Indicate if mixed tissue types have been collected, if possible contamination/ symbiosis/infection has been detected and special post collection treatments needs to be carried out	Yes
Relation tissue to voucher	"tissue and voucher from the same in situ individual", "tissue and voucher from the same in situ population"		Yes
Pre-preservation	"Anaesthesia", "Fixatives",	Chemicals used prior to tissue preservation	Optional
Tissue preservation	"Silica gel", "Alcohol", "Air dried", "Lyophilised"	The preservation/fixation of the tissue material	Yes
Transportation	"cooled throughout", "continuously dry", "evaporated during transport"	Rapid climatic changes support DNA degradation and might necessitate different laboratory treatments (e.g. usage of DNA repair kits)	Optional
Place of tissue deposit	Botanic Garden and Botanical Museum Berlin-Dahlem/D		Yes
Place of voucher deposit	Royal Botanic Gardens, Kew/GB		Yes
Notes	"female/male", "heavily grazed meadow"	Additional information of potential interest	Yes

Table 1. Example of a data collection sheet for DNA specific documentation.

2.2. Gathering information on the taxon to be collected

Local and regional floral and faunal listings, checklists, monographs, and databases are useful references in order to find detailed descriptions and information on where potentially to find and how to differentiate between related taxa. Further platforms that should be screened are the EDIT specimen and observation explorer for taxonomists (<http://search.biocase.org/edit/>) as well as the websites of the Global Biodiversity Information Facility (<http://www.gbif.org>). Flora Europaea (now available on CD) is the primary reference for the European flora. Euro+Med PlantBase (<http://www.euromed.org.uk/>) as well as the website at the Royal Botanic Gardens, Kew (<http://www.kew.org>), and Index Herbariorum (<http://sciweb.nybg.org/science2/IndexHerbariorum.asp>) are also useful sources of information. A detailed compilation of genera and families of flowering plants is provided by Kubitzki *et al.* (from 1990). The Guide to Standard Floras of the World (Frodin, 2001) gives an overview of available floras all over the World. For animals there might be similar literature available and proper homework should be done in advance.

Specific instructions on where, when, and how to get the specific organisms of interest can be obtained from experts or from people being familiar with the localities and/or the taxa. Precise information about localities where a particular taxon can be found may also be obtained from genetic resource centres, natural history associations, governmental agencies, species monitoring projects (for rarities), eco-geographic surveys (occasionally available), inventories (national and local), natural history collections (which give a historical perspective of the distribution), chorological accounts in botanical and zoological journals and distribution maps in revisions. However, often data might need to be verified from a number of sources especially when they are old. Sometimes there is a large variation between species as to what is known about their geographical distribution and their known populations. Local botanists and zoologists as well as ecologists might have a more detailed knowledge and may also be able to assist. Frequently, collections are made in an opportunistic way at a particular (perhaps remote) site, and more than one taxon is sampled. However, one should always know what to expect and what not to expect (e.g. species assemblages, phenology) when collecting with a specific method in a specific habitat at a specific time.

Information on putative diseases or pests that might infect the targeted species may also be useful. Collection time has to be kept in mind as well; flowering time or breeding season may differ within or between species and this can affect the sampling strategy. The same is true for animals with strong seasonal activity (e.g. many insects) – which only emerge as imago at a certain season each year.

In summary:

- Get ample information about your taxon prior to going out in the field to optimize collection success.

2.3. Collecting with permission

Collecting organisms - be they plants, animals or microorganisms in soil or water samples - must be in accordance with national and international legal aspects. Unauthorised collection can damage populations of native species, leading to potentially adverse effects and may have serious legal consequences.

Be aware that in several countries you need to apply for permissions (including collecting, export, CITES, and import permits, phytosanitary certificates containing the identification and description of the purpose of the tissue, etc.) several months before you go out in the field. Plan a minimum of 6 months ahead. Often cooperation with local scientists is mandatory to receive permissions - so try to establish contacts well in advance. Here the Index Herbariorum may be a good guide to localize botanists (<http://sciweb.nybg.org/science2/IndexHerbariorum.asp>). In some countries you must visit official authorities personally prior to going out in the field. Consider this in your schedule.

The following aspects should be considered in the context of doing legal collections:

- Information about how to collect legally can be obtained from institutes and/or official administrations. To find the relevant addresses in your country of interest contact the national CBD focal points (<http://www.cbd.int/countries/>).
- Permission from the land-owner/manager of the site/national park authorities and, in the case of protected species, the relevant government authority must be obtained.
- Permissions (permits) should preferably be in your hands before starting your travel.
- Permission should cover voucher specimens, tissue material and DNA of as broad a range of species (including those targeted) as possible.
- Obtaining permission can take a long time. General collection permits are often much more difficult to obtain than specific ones.
- Check whether target species are listed in international agreements or directives that give them special status. Of particular note are:
 - ✓ CITES (<http://www.cites.org>)
 - ✓ European Council Regulation (EC) No. 338/97 incl. Annexes http://ec.europa.eu/environment/cites/legis_wildlife_en.htm).
 - ✓ The Bern Convention (<http://www.ecnc.nl/doc/europe/legislat/bernconv.html>).
 - ✓ Habitat Directive (http://europa.eu.int/comm/environment/nature_conservation/eu_nature_legislation/habitats_directive/index_en.htm).

Contact the national custom authorities if specimens are to be moved between the EU and other countries. You will probably need both, an export permit from the country of origin and an import permit from your own country or place of residence.

In summary:

- Do not collect without permissions (collecting, exporting, importing, transporting).
- Plan well ahead as it is often time consuming to get the necessary permits.
- Contact local scientists with knowledge of and experience with the national or local administrative organisations. In some countries such contacts are mandatory.

2.4. Methodological considerations

Specific methodologies exist for sampling environmental, soil, bacterial, fungal, and algal specimens, and we will not focus on those here as most world-wide collection efforts tend to focus on major plant and animal groups.

2.4.1. Tissue collecting for plants

The best tissue for DNA analyses of plants is a piece of leaf, either from leaf buds or very young leaves as they feature many cells with high DNA content. Be aware that this does not account for the surrounding bud scales which are often lignified and may contain high amounts of secondary compounds for protection against predators. If no buds are available then tissue material of young leaves should be collected. For plants with pruinose or hairy leaves the surface (epidermis) sometimes has to be removed (e.g. Boraginaceae) as the silica on the leaf surfaces interacts with many DNA isolation kits (silica binds the DNA). Hard leathery leaves with few stomata as well as succulent leaves will not dry properly in silica gel as the stomata close after removal from the plant and the DNA in the mesophyll will be degrading fast during the slow tissue drying process. This often is the case for tropical or Mediterranean plants. In such cases, the leaves have to be cut into small stripes or pieces before their preservation in silica gel to ensure fast drying processes throughout the DNA containing tissue.

If leaves are soft and juicy or even succulent the DNA content per square centimetre is low in comparison to the vacuole content. This often causes low yields in DNA extraction. If this is the case, either larger amounts of leaf material have to be collected - then the tissue has to be dried fast since tissue with high water content is subject to fast degradation - or other plant parts should be considered for collection. Sepals and petals of the flowers as well as fruits feature larger cells with anthocyanins, carotinoids, flavons, flavonols or other secondary compounds in the vacuole or the chromoplasts, and/or starch and sugar in the amyloplasts. Using these tissues for DNA extraction will usually provide less DNA per cubic centimetre due to the enlarged cells, and purifying

the DNA might be more problematic as compared with leaf material. Nevertheless, Lin & Ritland (1995) reported high yields and good PCR amplification of DNA preparations from petals of several species. Thus, it may be worth trying petals as an alternative source of DNA. Alternatively, soft and juicy or succulent leaf parts may be directly put into saturated NaCl-CTAB buffer in the field (Rogstad, 1992). Pollen has rarely been used for DNA isolation (e.g. Simel *et al.*, 1997) though featuring only a haploid chromosome set which is sometimes advantageous for subsequent analyses.

Seeds are the life preservation stage for plants. In seeds, DNA is usually well-preserved in the long term, but accessibility may be difficult if seeds are surrounded by a large endosperm. Several groups have reported successful DNA isolation from seeds of various plant species (e.g. Wang *et al.*, 1993; Krishna & Jawali 1997; Kang *et al.*, 1998; von Post *et al.*, 2003). For large seeds, the endosperm should be removed prior to DNA extraction and only the embryo (which contains high amounts of DNA) should be used for isolation. For larger DNA yields it may be desirable to germinate seeds prior to DNA extraction; however, attention has to be paid to potential fungal contamination. This can, to some extent, be prevented by washing the seeds in a hypochlorite-solution prior to germination on sterilized media. Each seed represents a single individual; therefore, seeds should not be pooled prior to DNA extraction as this then presents a multi-individual community.

In general it is not recommended to collect lignified plant material for DNA extraction as lignin also hampers extraction efficiency. DNA isolation from wood is principally possible (e.g., Dumolin-Lapègue *et al.*, 1999; Deguilloux *et al.*, 2002), and some DNA isolation kits are especially designed for wood and lignified plant material. However, these DNA extractions can often be tricky, requiring large amounts of primary material and usually resulting in low yields. If only lignified stem material is available, or routine collection of leaf material is difficult, it is recommended to scratch off the bark and collect the cambium. For example, we obtained good yields of well-amplifiable DNA from cambium and cortical tissues of *Macaranga* trees from SE Asia (Weising, unpublished results). Thorns and spines should not be used for DNA extraction as the DNA content is usually too low. If you collect freshwater or marine plants, be very careful to remove epiphytes which often cover the leaf surfaces. As most plant species are associated to mycorrhizal fungi and some to rhizobia it is also not recommended to collect roots as DNA samples for plants. Try to avoid tissue that might be host to parasites (e.g. mildew) or other potential contaminants. If specific PCR primers are used for subsequent analyses such material can still be appropriate. However, potentially contaminated material should neither be used for restriction fragment analyses nor for any PCR assays with unspecific, arbitrary primers.

2.4.2. Tissue collecting for animals

Vertebrate DNA can be obtained from blood, and from a large variety of other tissues, including muscle, heart, liver, kidney, testes, bone, nail, embryonic tissue from placentas or eggs, pulp of feathers, skin and hair follicles. The mitochondrial DNA (mtDNA) can even be obtained from single hair shafts (Wilson *et al.*, 1995;

Gilbert *et al.*, 2007). Non-invasive samples (Smith & Wayne, 1996) such as hair, feather, foot pads, buccal or skin cell (swabs), faeces, urine, moulted skins, fish scales or fin clippings can all be useful for molecular genetic analysis, but a wide variety of problems can be encountered and appropriate solutions have to be found with such kind of material (for a recent review see Beja-Pereira *et al.*, 2009). However, invertebrate (terrestrial as well as aquatic) diversity is so great that generalities about tissue and extraction methods are very difficult to make. For minute organisms, more than one specimen can often constitute the tissue sample. For larger organisms various body parts can be selected, including legs, abdomen, feet, muscle biopsy etc. Care should be taken to avoid known problematic tissues, e.g., tissues rich in muco-polysaccharides, “slime” and hardened exoskeletons, guts and associated gut contents.

For sampling in micromammals, the Institutional Animal Care and Use Committee (IACUC) recommends ear punch, toe clipping and tail clipping. The ear punch method involves punching a hole or making a notch in the ear. Ear punch samples collected on animals do not require the use of anaesthesia or analgesics, but the ear punch must be disinfected between animals. Toe clipping involves removal of the distal phalange bone of one or more limbs. Tail clipping involves amputating a minute portion of the distal tail. A pair of sterile sharp scissors or scalpel can be used for this procedure and must be disinfected in between uses. After taking the sample, it should be either frozen or transferred to a sterile vial containing a minimum of 70% alcohol, or DMSO/EDTA/salt buffer (Seutin *et al.*, 1991).

For sampling in amphibians and reptiles we refer to chapter 20.

Bird blood can be collected from the jugular vein (right side of the bird's neck), brachial/ulnar vein (wing vein) or medial metatarsal vein (leg vein) using a hypodermic needle or butterfly needle, and a syringe, depending on the size of the bird and the amount of blood to be collected. In general, it is safe to collect 0.3-0.6 ml of blood per 100 g of body mass from living birds. However, it is always advisable to collect the minimum amount of blood necessary for the investigation. For some investigations blood spots (FTA, see chapter 1.5) are sufficient. The blood should immediately be transferred from the syringe to a sterile vial containing EDTA solution (e.g. purple top) and this should promptly be refrigerated then frozen when possible. More information on sampling in birds is available in chapter 21 of this manual.

Fish in the field are best euthanized in tricaine methane sulphonate. Care should be taken to avoid changes to acidic pH at high concentrations of the solute (see protocols on tricaine use, Alparma Animal Health (2001) and Brown (2003)). Fish are frequently sampled using muscle biopsy from the right side of the body (left side preserved intact for photodocumentation and morphological examination whenever possible), right eye removal, right side pectoral fin clips and occasionally gill material. Very small larvae and juveniles are sometimes dissected in half, with the caudal end being sacrificed for molecular analyses. Tissue explants can either be held dry in sealed vials along with, but separated from a moist tissue pad at 0-4°C underneath melting ice, or in cryoprotectant solution (L-15 medium, 10% Fetal Bovine Serum (FBS), 125 mM sucrose, 10%

DMSO, for further information see Moritz & Labbe 2008). More information on sampling in fish is available in chapter 22 of this manual.

Tissues that might contain parasites or other potential contaminants, such as gut contents, should be avoided whenever possible. One can get around contamination problems with specific PCR primers, but when generic fish primers are used on fish samples that included gut contents from fish that eat other fish, it is entirely possible to get both the predator and the prey amplified.

2.5. Tissue/DNA collection techniques

→ Remember that when collecting tissue/DNA from voucher specimens.

Water (at any temperature) and temperature (depending on moisture) cause the highest DNA degradation. *Warm and moist is bad. Cold and dry is good.*

Certain analysis techniques demand certain collecting techniques.

Certain collecting techniques are advantageous under certain climatic conditions.

For optimal results, it is recommended to use one of the following four strategies of tissue and DNA preservation in the field:

- **Freezing**
- **Fast drying**
- **Storage in liquid media**
- **DNA isolation in the field**

The “gold standard” is to immerse all specimens/tissues immediately into vapor-phase liquid nitrogen (VPLN) upon collecting using dry-shippers or cryotanks in the field. Everything short of this represents some sort of compromise. It should be noted that freezing can decrease yields of mitochondrial DNA if this is the focal point – but if genomic DNA with just some mtDNA is desired, freezing will produce adequate quantities. Many of the compromises described below are either necessary or acceptable, or both. Depending on how many compromises are introduced, the samples might not subsequently be amenable to protein, RNA, genomic or other studies. Ancient DNA studies frequently take advantage of samples that have undergone significant degradation, yet are still amenable to *e.g.* mtDNA analysis. Taking large liquid nitrogen tanks or dry ice to the field could result in logistical obstacles that could compromise the collection effort. If any of the alternative collection techniques described below would enable orders of magnitude more samples to be collected in perfect conditions for most mitochondrial, chloroplast and nuclear DNA work, then the choice about how to collect is obvious.

The rapid drying of plant tissues with desiccating agents was first suggested by Liston *et al.* (1990) and Chase & Hills (1991). At present, **silica gel** is the most common fast drying procedure for plant collecting (*e.g.* Cliquet & Jackson, 1997). It is especially recommended in temperate regions, for plants which are non-succulent, non-woody, with a non-waxy epidermis. The leaf material is collected in paper bags (preferably tea bags as these allow evaporation) along with at least 10 times the weight of dry silica gel. The silica gel must remain dry during the

whole storage process. It should be exchanged when the colour of the moisture indicator dye changes (2-3 times; approximately every 6-24 hours, depending on the tissue). Under humid conditions the use of screw-capped vials for storing the tea bags may be preferable as these effectively exclude external moisture.

Dried samples are easy to handle, require no cooling devices in the field, and can be stored for years at room temperature under desiccated conditions. Problems may arise if the drying process is not fast enough, *e.g.*, in xeromorphic plants with a fleshy mesophyll and a thick, leathery and highly cutinized and waxy epidermis. Such leaves tend to close their stomata after first contact with silica gel, considerably slowing down the drying process with a negative influence on the quality and quantity of DNA retrieval. Problems of this kind can be circumvented by cutting the leaf tissue into smaller pieces before placing it into the paper bag (see also point 2.4.1 above).

An alternative method of desiccation involves the crushing of the leaf tissue onto FTA paper, which is a commercial medium initially developed for long-term storage of blood spots. **FTA cards** are patented by Whatman to simplify the handling and processing of nucleic acids under ambient temperatures (Smith & Burgoyne, 2004) and are suitable for both plant and animal tissues. FTA cards facilitate sample collection in remote locations and simplify sample transportation. According to the manufacturer, virtually any type of organismic material can be used and a variety of configurations are available to meet specific requirements. We recommend using the FTA method for juicy tissue. The FTA card contains chemicals that lyse cells, denature proteins and protect nucleic acids from nucleases as well as from oxidative and UV damage. The released nucleic acids are entrapped in the fiber matrix and remain immobilized and stabilized for transport, immediate processing or long-term storage at ambient temperature. The amount of DNA that can be stored on an FTA card is limited. According to the manufacturers, FTA cards rapidly inactivate microorganisms, including blood-borne pathogens, and prevent the growth of bacteria. Up to now, 20 years of experience for DNA storage on FTA cards exist but the DNA elution efficiency has been much improved only recently. DNA released from FTA cards proved to be a suitable substrate for PCR-based methods (Mas *et al.*, 2007), whereas restriction enzyme applications were less satisfactory because of low yields (Gemeinholzer, unpublished information). Continuous efforts by the company to overcome this problem are in progress. Contamination is one of the biggest problems when using FTA cards, which have to be handled with special care. Special storage and transportation equipment is available from the manufacturer.

Another substance, not commonly used for fast drying specimens for scientific purposes yet but patented as desiccant, *e.g.* for drying of biomass, is **Zeolite**. It is a silicate made from equal parts of silicon tetroxide and aluminum tetroxide which might hold some potential for very rapid drying (Silva *et al.*, 2007). However, to date none of the authors of the present survey has any experience with Zeolite.

Tissue collection **in liquid** media can be advantageous if fast drying or freezing in the field is not possible. In plants, however, early work has shown that treatments with different types of organic solvents like ethanol, methanol, or

formaldehyde are unsuitable and result in DNA degradation after a few days (Doyle & Dickson, 1987; Pyle & Adams, 1989). Nevertheless, in later studies the successful use of 95% or absolute ethanol to preserve leaves from various plant species was reported (Murray Pitas, 1996; Flourney *et al.*, 1996). For example, Flourney *et al.* (1996) showed that leaf tissue of spinach, juniper and broccoli gave good yields of high molecular weight DNA after almost one year of storage in ethanol, provided that a proteinase was included in the DNA extraction buffer. Rogstad (1992) described the preservation of small pieces of leaf tissue in NaCl-saturated solutions of cetyltrimethylammonium bromide (CTAB) at room temperature. This technique has been used quite often since then, and has been effective in our hands for *Suaeda*, *Salicornia* and other genera with succulent species of the Chenopodiaceae, as well as Bromeliaceae. However, samples should be processed as soon as possible after returning to the laboratory, and a CTAB-based DNA isolation protocol (*e.g.*, Doyle & Doyle, 1987) should be applied. For animal tissue, storage in ethanol is most advisable. The higher the alcohol concentration the better, absolute alcohol is best. The ratio of ethanol to the sample volume should be about 3:1 (Seutin *et al.*, 1991; Presnell *et al.*, 1997). Alternatively, animal tissues can be stored in salt-EDTA-DMSO solutions that also hamper degradation processes, than however care has to be taken concerning subsequent DNA extraction as many kits are based upon silica (salt) binding membranes not determined for the salt buffer solution.

In some instances, logistical problems in the field, or problems with permits make it nearly impossible to transport tissues. To circumvent these problems, Nickrent (1994) suggested to prepare a raw extract using a standard CTAB DNA extraction buffer in the field, and to store the homogenized and filtered extract at ambient temperature until returning to the laboratory for completing the isolation procedure. A more recent alternative is the use of automated **field DNA extractions**. Several companies sell an instrument capable of taking a 96-well plate of digested tissues (for which you need a small incubator/shaker) and turning it into a plate of extracted, archivable DNA using magnetic beads in about 30 minutes – on a robotic platform that will fit into a case for many commercial airlines, weighs less than 45 kg, and runs on standard power.

If you extract DNA in the field or store tissue in vials, be aware that qualitative differences between different vial manufacturers exist. It is important to prevent evaporation, *e.g.* during exposition of the vials to low air pressure in planes. One should also be aware that cryo-tubes are designed for contraction during cooling processes, but might not be the best choice for short-term storage above room temperature.

In general, we strongly recommend testing the planned tissue preservation strategy and DNA extraction methods on your group of organisms well before going to the field. Especially in plants, DNA extraction can be tricky because of the frequent presence of diverse polysaccharides, polyphenols and other secondary compounds that may severely hamper molecular analyses (for a review, see Weising *et al.*, 2005). Optimize your technique before large scale collecting in remote areas. While considering the different options for tissue collection, also think beyond your own study to other potential uses of the material.

Silica gel is made of hygroscopic sodium silicate which is non-toxic, non-flammable, non-reactive and stable with ordinary usage; however, it might be irritating to the respiratory tract, may cause irritation of the digestive tract, and dust from the beads may irritate the skin and the eyes, so precautions for handling should be taken. Most often silica gel is pre-mixed with a visible indicator of the moisture content. Previously cobalt chloride (CoCl_2) was added, which causes the indicator to change from blue to pink when hydrated. Cobalt chloride is toxic and may be carcinogenic - only handle with gloves! Recently, the indicator has been substituted by the less dangerous ammonium iron sulphate ($\text{NH}_4\text{Fe}(\text{SO}_4)_2$) which causes the gel to change from orange (anhydrous) to colourless (hydrated). Crystalline silica powder or silica dust are colourless, have a higher hygroscopic capacity than silica gel and need to be mixed with some moisture indicator, too. Crystalline silica dust can cause silicosis and should only be used with face masks or handled under a laboratory hood or laminar flow. Once silica gel is saturated with water, the gel can be re-used after desiccation. This can be achieved by heating to 120°C (250°F) for two hours or even using a frying pan). It is not recommended to use a microwave oven as too high temperatures can lead to melting processes. If silica gel is to be reused, care must be taken to ensure that no fragments of previously dried tissues are carried over.

2.6. Logistics, precautions and safety

If possible, make a prior visit to the site to confirm the identity of the taxa to be sampled and to choose an adequate season for collecting. Such a pre-visit also provides an opportunity to collect additional voucher specimens in a different life stage, to study maps of the area and to set up a rough timetable for the collecting trip. Detailed climatic data and recent weather reports (particularly important when collecting in mountainous areas) are available from the internet for most places in the world. Check the area for accommodation and service stations, particularly in remote regions. Think through contingency plans in the event of an emergency and carry appropriate telephone numbers with you. Where telephone signal coverage is limited, radio communication may be necessary. Do not collect all by yourself in isolated areas. Local guides can provide invaluable help in finding your way and avoiding problems of any kind. Before you leave, give your itinerary to someone who will take care and appropriate action if regular pre-arranged contact is lost.

Check beforehand if electricity, gas, or any other equipment you need is available on the site.

Concerning safety in the field, literature on possible health hazards associated with the collection and handling of post-mortem zoological material does exist (Irvin *et al.*, 1972), also including a checklist of diseases mainly related to collecting samples from vertebrates. Be aware you might need vaccination (e.g. hepatitis), especially for collecting animal blood.

3. In the field

On arriving at a collecting site, it is important to first estimate the number, size and distribution of populations of the species under consideration. Any collection is started by filling out the general comments in the collection sheet (who, when, where). A GPS should be used for proper geo-referencing (see also chapter 4). Extra batteries should be brought along, and backups be done if electronic storage of data is the only record. Otherwise, GPS measurements should be recorded in a pocketbook.

Samples are usually identified by morphological characters, and photographed prior to tissue sampling and preparation of a voucher. If this is going to be time-consuming, then care must be taken to minimize degradation of the samples in the interim. DNA degradation starts immediately and the tissue sample designed for DNA analysis should be secured as fast as possible, *e.g.*, by adding silica gel. Be aware that voucher specimens can be very tolerant to conditions that the DNA is not. Depending on the storage process, several changes or iterations might be necessary. For example, the silica gel (for drying plant tissue) or ethanol (for conserving animal tissue) might need changing once or several times after the initial preservation (see also above).

At least one voucher specimen per population should be kept for reference, but frequently vouchers of all specimens turn out to be valuable or necessary. When morphological diversity within the population is large, several individuals should be sampled. Keep a record about which DNA sample is directly associated with the voucher. This cross link is very important for documentation purposes. In case DNA is taken from the same population but not from the actually vouchered individual, then this has to be noted down accordingly. Mixed collections are to be avoided. For some (especially large-sized) animals it is not permitted or otherwise impossible to make a voucher. In these cases, an e-voucher, *e.g.* a photo, should be prepared instead. As herbarium vouchers accompanying the DNA sample serve as evidence for the identification of a sample, they should ideally be taken from a fertile individual, displaying flowers or fruits. Characters that are likely to be lost after processing should be captured, *e.g.* by providing a description on the specimen label or by creating an e-voucher. These characters may include habit, flower or fruit colour, smell, and the presence and colour of sap.

Individuals from populations should be sampled as randomly as possible. Whatever method is used (*e.g.* transect, random), biased sampling (the selection of individuals on the basis of appearance, ease of collection, etc.) should be avoided. Material should be checked for pathogens, fungi or other organisms on the surfaces to avoid contamination.

For collecting plant tissue in silica gel, the specimen is put into paper bags, preferably tea bags, and put in a zip-lock bag or a screw-capped vial with dry silica gel. Bags are then folded and stapled, and seams checked for potential leakage. Each bag is labelled individually with unique identifiers being traceable to the voucher specimen as well as site information, collection date, collector, collection techniques, etc. (see Table 1). On tea bags, labelling with pens or

pencils is most advisable. It is recommended also to label the zip-lock bag. In general, several tea bags can be placed into one zip-lock bag; however, attention has to be paid to the silica gel which must be dry during the whole storage process. During the first days of storage, the silica gel will therefore have to be changed at certain intervals.

A permanent marker should be used for labelling collection tubes or vials. Information on the tube should be precise and reduced to a minimum. Markers should be checked for staying permanent in contact with ethanol and salt solution. The same labelling should be applied to the voucher and tube if the tissue is derived from the same specimen. The unique ID number on the tube must refer to a database where additional information can be found. Filling and labelling vials or at least printing labels prior to field work may substantially save time.

A critical source of potential error is placing tissues into the wrong tube, or multiple tissues into the same tube. This can be avoided by having two working boxes – one that contains the empty (or pre-filled) tubes and another to where the labelled tubes are being transferred after the sample has been added. The tube's identification number and sample ID should be verified in the database.

Much care needs to be taken to avoid sample-to-sample contamination between handling subsequent specimens. Tweezers, scissors, scalpels, etc. used to collect or fragment tissue, should be rinsed shortly in alcohol after handling each individual specimen. Sterilization of instruments in certain intervals, *e.g.* by flame, bleach treatment or use of 96% alcohol is an important precaution to combat contamination.

Samples and chemicals are best stored in a cool, dark, dry place to minimize chemical reactions, and (UV) light exposure. Solutions used (anaesthesia, fixative, CTAB solutions etc.) and the duration of the treatment should be entered in the "tissue preservation" field of the collection spreadsheet in the database.

Before moving to another field site, it is recommended to clean and sterilise all field equipment (clothes, plastic holding jars/bottles/plastic ware) to prevent disease transmission and to minimize cross-contamination of localities. Also check clothing and shoes for attached seeds or fruits before leaving a collecting site. Collectors can unwittingly transfer organic material from one population of a species to another. With regard to plant seeds, this could lead to undesirable out-crossing events in certain narrow endemic species. Human-dispersed biota might also become a serious pest at another locality, or lead to hybridisation with closely related species resulting in loss of genetic integrity of the populations affected.

In the case of higher vertebrates, extra care should be taken because many health hazards for humans are associated with the handling of post-mortem material, like blood. One should also be aware that the plant and animal parts touched during collecting may be poisonous. Care should be taken about irritant hairs; gloves should be worn wherever appropriate.

Particularly when collecting material from rare species at sites close to public areas, attracting attention should be avoided by inconspicuous behaviour. Heavy

trampling around the collecting site, potentially drawing attention to rare plants, is to be avoided as well.

It is advisable to check and complete the field notes after each collection day. Even minor details may be of later interest. The collection database should be updated as soon as possible.

3.1. Standard of work

In zoology, sampling methods and strategies can be very diverse, depending on the taxa under investigation, ranging from large terrestrial mammals, either nocturnal or diurnal, to flying birds, aquatic vertebrates and many different invertebrates. In botany, sampling aquatic plants is different from sampling succulent land plants, and different secondary compound compositions may demand different collecting techniques. It is therefore highly important to develop standard protocols for each of the processes that must apply to each particular type of fauna and flora when working in the field. To make the collecting of samples as efficient, representative, reliable and homogeneous as possible one may not allow too much space for improvisation. This is especially true if the collection procedure needs to be repeated for one reason or the other. As exaggerated sampling will have a negative impact on fauna and flora, it is one's obligation to make sure that not more samples than absolutely necessary are processed. Before going out to the field, it is therefore highly recommendable to establish written protocols that describe all processes in detail, always based on the existing bibliography and on previous successful experiences.

4. Transportation of samples and arrival at the laboratory

Air and ground carriers have been changing their regulations and requirements for transportation of ethanol, liquid nitrogen, nitrogen dry shippers and dry ice frequently in recent years. Knowledge of current procedures, labelling requirements, etc., will help to avoid catastrophic sample loss due to delays and unexpected storage periods *en route*. Samples should be brought to the laboratory as fast as possible, and under as stable conditions as possible. Try to maintain control/ownership of your specimens. It is recommended to accompany one's specimens personally rather than sending specimens via mail as they might get lost. It is advisable to obtain information about the reliability of mail shipments in the respective countries beforehand. Sometimes it is possible to contract parcel post insurance; however, if the parcel is lost, most often the value is irrecoverable. Sending specimens via ocean freighter from one continent to another is not recommended as long transportation times have a potentially negative effect on the specimens' DNA quality. If vials are used for transportation, care should be taken that lids are tightly closed, vials don't get squeezed, and changes in air-pressure and temperature won't affect the samples. Sometimes it is advisable to wrap cling-film or Stretch-Tite around the lids of vials before the transport to avoid evaporation. We recommend taking the samples in the cabin when travelling by plane, since temperature and air pressure are more constant there. If silica gel is used, the corresponding material safety data sheet should be carried along if questioned at borders.

Back to the laboratory, samples should be checked and transferred to stable conditions for short, medium or long term storage as soon as possible. Care should be taken about documentation, and missing information about transport and final destination be added.

5. Deposition of material in natural history collections

It is mandatory to guarantee both short-term and long-term preservation of the collected specimens to deposit material in natural history collections. The scientific institutions that will receive the material must therefore ensure that there is sufficient space and budget available to correctly house and maintain the specimens for the long-term. As the samples collected in the field have only been prepared in a provisional way, additional handling and data entry will be necessary once they are deposited in a research collection. In the case of tissue samples, permanent and safe physical space in, *e.g.*, freezers and cryo-vats must be available and accessible. One should be aware that, as a general rule, most natural history collections are only willing to store (tissues and/or DNAs from) vouchered and well documented material.

Once incorporated into a national collection, voucher specimens may be examined by many researchers over time. If the country of origin placed restrictions on the use of voucher material in the collection (or export) permit, such as stipulating that vouchers may not be used for third-party DNA extraction or not to be sent on loan to another institution, then these restrictions need to be noted on the specimen itself (and ideally also in the management system of the collection housing the specimen; compare Savolainen *et al.*, 2006).



Fig. 1. A. Out in the field (Siberia, Altai region) for DNA collection; B. Taking samples in the field; C. Sampling marine organisms; D. Example on how specimens (here *Leuciscus leuciscus* (Linnaeus, 1758)) are photographed before taking tissues; E. Vials of different types; F. Taking tissue samples from a wire; G. Laboratory equipment if tissue is taken in the lab; H. Barcode labelled specimen and the corresponding database;. (Picture A by N. Enke; B by A. Camacho, C. by Panglao Marine Biodiversity Project 2004; D by M. Rawson; E. by G. Droege; F & H. by I. Rey; G. by G. Droege and H. Zetsche.

6. References

- ALPHARMA ANIMAL HEALTH 2001. MS222 - tricaine methane sulphonate. *Technical Bulletin* 5.
(<http://www.europharma.no/fiskehelse/datablad/bedovelse/MS222.pdf>).
- ANONYMOUS 2002. Bonn Guidelines on Access to Genetic Resources and Fair and Equitable Sharing of the Benefits Arising out of their Utilization. Secretariat of the Convention on Biological Diversity. Montreal, Quebec, Canada: 20.
(<http://www.cbd.int/doc/publications/cbd-bonn-gdls-en.pdf>)
- BEJA-PEREIRA, A., OLIVEIRA, R., ALVES, P.C., SCHWARTZ, M.K. & LUIKART, G. 2009. Advancing ecological understandings through technological transformations in noninvasive genetics. *Molecular Ecology Resources* 9: 1279-1301.
- BROWN, C. 2003. Fish and Amphibian Euthanasia. Cornell Centre for Animal Resources and Education. CARE306.01.
(<http://www.research.cornell.edu/care/documents/SOPs/CARE306.pdf>).
- CBOL PLANT WORKING GROUP 2009. A DNA barcode for land plants. *Proceedings of the National Academy of Sciences* 106: 12794-12797.
- CHASE, M.W. & HILLS, H.H. 1991. Silica gel: an ideal material for field preservation of leaf samples for DNA studies. *Taxon* 40: 215-220.
- CHASE, M.W. & FAY, M.F. 2009. Barcoding of Plants and Fungi. *Science* 325: 682-683.
- CLIQUET, S. & JACKSON, M.A. 1997. Comparison of air-drying methods for evaluating the desiccation tolerance of liquid culture-produced blastospores of *Paecilomyces fumosoroseus*. *World Journal of Microbiology and Biotechnology*, 13 (3): 299-303.
- DEGUILLOUX, M.F., PEMONGE, M.H. & PETIT, R.J. 2002. Novel perspectives in wood certification and forensics: dry wood as a source of DNA. *Proceedings of the Royal Society London B* 269: 1039–1046.
- DELLAPORTA, S.L., WOOD, J. & HICKS, J.B. 1983. A plant DNA miniprep: version II. *Plant Molecular Biology Reporter* 1: 19-21.
- DESSAUER, H.C. & HAFNER, M.S. 1984. Collections of frozen tissues: value, management, field and laboratory procedures, and directory of existing collections. Association of Systematics Collections publication, University of Kansas, Lawrence.
- DESSAUER, H.C., COLE, C.J. & HAFNER, M.S. 1996. Collection and storage of tissues. In: HILLIS, D.M., MORITZ, C. & MABLE, B.K. (Eds.). *Molecular Systematics*. Sinauer Associates, Sunderland, MA, 2nd Edition: 29-47.
- DOYLE, J.J. & DICKSON, E.E. 1987. Preservation of plant samples for DNA restriction endonuclease analysis. *Taxon* 36: 715-722.
- DOYLE, J.J. & DOYLE, J.L. 1990. Isolation of plant DNA from fresh tissue. *Focus*, 12: 13-15.

- DUMOLIN-LAPÈGUE, S., PEMONGE, M.H., GIELLY, L., TABERLET, P. & PETIT, R.J. 1999. Amplification of oak DNA from ancient and modern wood. *Molecular Ecology* 8: 2137-2140.
- FALK, D.A. & HOLSINGER, K.E. 1991. *Genetics and Conservation of Rare Plants*, Centre for Plant Conservation, New York: 225-237.
- FAZEKAS, A.J., KESANAKURTI, P.R., BURGESS, K.S., PERCY, D.M., GRAHAM, S.W., BARRETT, S.C., NEWMASER, S.G., HAJIBABAEI, M. & HUSBAND, B.C. 2009. Are plant species inherently harder to discriminate than animal species using DNA barcoding markers? *Molecular Ecology Resources* 9: 130-139.
- FLOURNOY, L.E., ADAMS, R.P. & PANDEY, R.N. 1996. Interim and archival preservation of plant specimens in alcohols for DNA studies. *BioTechniques* 20: 657-660.
- GILBERT, M.T.P., TOMSHO, L.P., RENDULIC, S., PACKARD, M., DRAUTZ, D.I., SHER, A., TIKHONOV, A., DALÉN, L., KUZNETSOVA, T., KOSINTSEV, P., CAMPOS, P.F., HIGHAM, T., COLLINS, M.J., WILSON, A.S., SHIDLOVSKIY, F., BUIGUES, B., ERICSON, P.G.P., GERMONPRÉ, M., GÖTHERSTRÖM, A., IACUMIN, P., NIKOLAEV, V., NOWAK-KEMP, M., WILLERSLEV, E., KNIGHT, J.R., IRZYK, G.P., PERBOST, C.S., FREDRIKSON, K.M., HARKINS, T.T., SHERIDAN, S., MILLER, W. & SCHUSTER, S.C. 2007. Whole-Genome Shotgun Sequencing of Mitochondria from Ancient Hair Shafts. *Science* 317: 1927-1930.
- GROVES, C. 2003. *Drafting a conservation blueprint: A practitioner's guide to planning for biodiversity*, The Nature Conservancy. Island Press, Washington: 457 pp.
- GUARINO, L., RAO, V.R. & REID, R. 1995. *Collecting plant genetic diversity. Technical guidelines*. CAB International, Wallingford, UK: 768 pp.
- HAJIBABAEI, M., SINGER, G.A.C., HEBERT, P.D.N. & HICKEY, D.A. 2007. DNA barcoding: how it complements taxonomy, molecular phylogenetics and population genetics. *Trends in Genetics* 23: 167-172.
- HAMRICK, J.L., GODT, M.J.W. & SHERMAN-BROYLES, S. L. 1995. Gene flow among plant populations: Evidence from genetic markers. In: HOCH, P.C. & STEPHENSON, A.G. (Eds). *Experimental and Molecular Approaches to Plant Biosystematics*. Missouri Botanical Garden Press, St. Louis: 215-232.
- HANNER, R.H. & GREGORY, T.R., 2007. Genomic biodiversity research and the role of biorepositories. *Cell Preservation Techniques* 5: 93-103.
- HEBERT, P.D.N., CYWINSKA, A., BALL, S.L. & DEWAARD, J.R. 2003. Biological identifications through DNA barcodes. *Proceedings of the Royal Society London B* 270: 313-321.
- IRVIN, A.D., COOPER, J.E. & HEDGES, S.R. 1972. Possible health hazards associated with the collection and handling of post-mortem zoological material. *Mammal Review* 2: 43-54.

- ISBER. 2008. Best practices for biorepositories: Collection, storage, retrieval and distribution of biological materials for research. *Cell Preservation Techniques* 6: 1-58.
- KANG, H.W., CHO, Y.G., YOON, U.H. & EUN, M.Y. 1998. A rapid DNA extraction method for RFLP and PCR analysis from a single dry seed. *Plant Molecular Biology Reports* 16: 1-9.
- KRISHNA, T.G. & JAWALI, N. 1997. DNA isolation from single or half seeds suitable for random amplified polymorphic DNA analyses. *Annals of Biochemistry* 250: 125-127.
- KUBITZKI, K. (Ed.) 1990. *The families and genera of vascular plants*, Springer, Berlin - Heidelberg, Germany.
- LIN, J.-Z. & RITLAND, K., 1995. Flower petals allow simpler and better isolation of DNA for plant RAPD analyses. *Plant Molecular Biological Reports* 13: 210-213.
- LISTON, A., RIESEBERG, L.H., ADAMS, R.P., DO, N. & ZHU, G. 1990. A method for collecting dried plant specimens for DNA and isozyme analyses, and the results of a field experiment in Xinjiang, China. *Annals of the Missouri Botanical Garden* 77: 859-863.
- MARSHALL, D.R. & BROWN, A.H.D. 1975. Optimum sampling strategies in genetic conservation. In: Frankel, O.H & Hawkes, J.G. (Eds). *Crop genetic resources for today and tomorrow*. Cambridge University Press, Cambridge: 492 pp.
- MAS, S., CRESCENTI, A., GASSÓ, P., VIDAL-TABOADA, J.M. & LAFUENTE, A. 2007. DNA cards: determinants of DNA yield and quality in collecting genetic samples for pharmacogenetic studies. *Basic and Clinical Pharmacology and Toxicology* 101: 132-137.
- MORITZ, C. & LABBE, C. 2008. Cryopreservation of goldfish fins and optimization for field scale cryobanking. *Cryobiology* 56: 181-188.
- MURRAY, M.G. & PITAS, J.W. 1996. Plant DNA from alcohol-preserved samples. *Plant Molecular Biology Reports* 14: 261-265.
- NEEL, M.C. & CUMMINGS, M.P. 2003. Genetic consequences of ecological reserve design guidelines: an empirical investigation. *Conservation Genetics* 4: 427-439.
- NICKRENT, D.L. 1994. From field to film: rapid sequencing methods for field-collected plant species. *BioTechniques* 16: 470-475.
- PRENDINI, L., HANNER R. & DESALLE, R. 2002. Obtaining, storing, and archiving specimens and tissue samples for use in molecular studies. In: DESALLE, R., GIRIBET, G., & WHEELER, W. (Eds). *Techniques in molecular systematics and evolution*. Birkhauser Verlag, Basel: 407 pp.
- PRESNELL, J.K., HUMASON, G.L. & SCHREIBMAN, M.P. 1997. *Humason's Animal Tissue Techniques*. Johns Hopkins University Press, 5th ed: 572 pp.
- PYLE, M.M. & ADAMS, R.P. 1989. *In situ* preservation of DNA in plant specimens. *Taxon* 38: 576-581.

- ROGERS, S.O. & BENDICH, A.J. 1985. Extraction of DNA from milligram amounts of fresh, herbarium and mummified plant tissues. *Plant Molecular Biology* 5: 69-76.
- ROGSTAD, S.H. 1992. Saturated NaCl-CTAB solution as a means of field preservation of leaves for DNA analyses. *Taxon* 41: 701-708.
- SAVOLAINEN, V., POWELL, M.P., DAVIS, K., REEVES, G. & CORTHALS, A. (Eds) 2006. *DNA and Tissue Banking for Biodiversity and Conservation: Theory, Practice and Uses*. Kew Publishing, Royal Botanic Gardens Kew & IUCN: 168 pp.
- SEUTIN, G., WHITE, B.N. & BOAG, P.T. 1991. Preservation of avian blood and tissue samples for DNA analyses. *Canadian Journal of Zoology* 69: 82-90.
- SILVA, B., COOK, C. & LEE, S.B. 2007. Evaluation of Zeolite as a substrate for Collection and Storage of DNA. Abstract accepted and poster at the 2007 American Academy of Forensic Sciences meeting, February 2007, San Antonio, TX.
- SIMEL, E.J., SAIDAK, L.R. & TUSKAN, G.A. 1997. Method for extracting genomic DNA from non-germinated gymnosperm and angiosperm pollen. *BioTechniques* 22: 390-394.
- SIMIONE, F.P. 1992. *Cryopreservation manual*. Nalge Company, Rochester, New York: 25 pp.
- SINGH, M., CHABANE, K., VALKOUN, J. & BLAKE, T. 2006. Optimum sample size for estimating gene diversity in wild wheat using AFLP markers. *Genetic Resources and Crop Evolution* 53: 23-33.
- SMITH, L.M., & BURGOYNE, L.A. 2004. Collecting, archiving and processing DNA from wildlife samples using FTA® databasing paper. *BMC Ecology*, 4.
- SMITH, T.B., & WAYNE, R.K. 1996. *Molecular Genetic Approaches in Conservation*. Oxford University Press, US: 483 pp.
- VALENTINI, A., POMPANON, F. & TABERLET, P. 2009. DNA barcoding for ecologists. *Trends in Ecology and Evolution* 24: 110-117.
- VON POST, R., VON POST, L., DAYTEG, C., NILSSON, M., FORSTER, B.P. & TUVESON, S. 2003. A high-throughput DNA extraction method for barley seed. *Euphytica* 130: 255-260.
- WANG, G.-L., WING, R.A. & PATERSON, A.H. 1993. PCR amplification from single seeds, facilitating DNA marker-assisted breeding. *Nucleic Acids Research* 21: 2527.
- WEISING, K., NYBOM, H., WOLFF, K. & KAHL, G. 2005. *DNA fingerprinting in plants. Principles, methods and applications*. 2nd edition. CRC Press, Taylor and Francis Group, Boca Raton, FA: 472 pp.
- WILSON, M.R., POLANSKEY, D., BUTLER, J., DIZINNO, J.A., REPLOGLE, J. & BUDOWLE, B. 1995. Extraction, PCR amplification and sequencing of mitochondrial DNA from human hair shafts. *Biotechniques* 18: 662-669.

7. Appendices

Appendix 1: Top Ten List – DOs and DON'Ts

1. Try to do what is BEST – NOT what is EASIEST – This starts with tissue sampling for later DNA analysis. Try to get the tissue/DNA preserved in the best state as early in the pipeline as possible so that degraded DNA is not what enters the biorepository.
2. Strive for the GOAL: Specimen vouchered in an accessible collection, tissue and/or DNA extract in an accessible biorepository, sequences in GenBank, all metadata available/included. ****ANY MISSING PIECE REDUCES THE VALUE****
3. DO your homework – do you know: what to expect? What to do with it when you get it? How to transport? How to record (what) data?
4. DON'T collect, export, import or transport specimens, tissues, or DNAs without the necessary official permits.
5. DON'T put off metadata documentation until later – it is harder, takes significantly longer to do so, and usually ends up less complete and accurate when postponing it.
6. Do realize the difference (in time, resources, necessary partnerships, etc) between building a reference library of vouchered, high-quality specimens, tissues, DNAs and sequences and just collecting and barcoding to get a quick identification of something you are not going to study any further.
7. Do recognize the limitations of compromising or taking shortcuts on easier/quicker/cheaper methods – use best practices.
8. Do AVOID sample-to-sample contamination.
9. Do ASK FOR HELP or advice if not sure about the best way of how to proceed.
10. OPTIMIZE short- and long-term preservation of the collected specimens.

Appendix 2: Checklist of possible equipment for collection trips

Chemicals and their storage

- 95% (> 70%) ethanol (DO NOT SUBSTITUTE WITH ANY OTHER TYPE OF ALCOHOL)
- DMSO salt buffer
- Saturated NaCl-CTAB buffer
- Distilled water (or deionized water)
- Various plastic jars/bottles (with watertight cap) for transporting chemicals
- Paper envelope which is bleach free
- Silica gel
- FTA paper
- Cling-film or Stretch-Tite for vial wrapping is sometimes advantageous during transport

Capture/storage equipment

- Waterproof plastic jars/bottles or Tupperware
- Plastic Zip-lock bags (various sizes)
- Paper bags
- Scissors
- Scalpel
- Tweezers
- Vials or Microtubes (screw cap with O-ring) – one for each individual sampled (2 ml or various sizes)
- Pipette or medicine dropper – for filling microtubes with solutions

Miscellaneous

- Fine point sharpie markers
- Micron archival ink pens
- Pencils
- Labels

Chapter 8

Sampling arthropods from the canopy by insecticidal knockdown

by

Andreas Floren

Department of Animal Ecology and Tropical Biology, Biocenter
University of Würzburg, Am Hubland, D-97074 Würzburg, Germany
Email: floren@biozentrum.uni-wuerzburg.de

Abstract

Insecticidal knockdown or canopy fogging is an easy-to-apply method to explore the canopy habitat, which harbours an abundant and diverse fauna of arthropods but which is still largely neglected in research. The method is sufficiently developed that a large proportion of the canopy fauna can be collected semi-quantitatively without causing much spatiotemporal disturbance. This requires the use of natural pyrethrum diluted in a paraffin-like carrier substance. Natural pyrethrum is highly specific to arthropods and quickly destroyed in sunlight without leaving persistent toxic substances in the ecosystem. The large dependence of the fogging method on the weather conditions are more than just compensated by the faunistic data allowing a tree specific analysis of the diversity, structure and dynamics of arboreal communities. Today, fogging produces more than descriptive data but is used in experimental research, like the biodiversity exploratories established in Germany, which aim at investigating the relation between biodiversity and ecosystem functioning.

Key words: Fogging, community, natural pyrethrum, pyrethroids

1. Introduction

I remember how astonished I was when I heard in a lecture about forest ecology at the beginning of my study how little we still know about the functioning of forest ecosystems and how far we still have to go before we might be able to use such complex ecosystems in a sustainable way. Evidence for this comes from the regularly occurring gradations of phytophagous or saproxylic insects, which cause enormous economic damage every year. How is this possible in a country with such a long history in forest research (Küster, 1998) I thought? Today, after 18 years of forest research I think part of the answer can be found in the canopy, a habitat that has simply been forgotten in the past.

One can say that the basics of modern canopy research lies in tropical rain forests where species diversity shows a maximum (Stork *et al.*, 1997; Linsenmair *et al.*, 2001; Basset *et al.*, 2003a). This was demonstrated by Erwin's work on canopy arthropods and his estimation of global species richness (Erwin, 1982). He applied the canopy fogging method, which was until then largely unfamiliar (Southwood, 1961; Southwood *et al.*, 1982), to individual trees of a lowland rain forest focusing on beetles in his analysis. From his data he concluded that global species richness must be much higher than the assumed two million species of plants and animals. His two-page paper caused a reorientation of biodiversity research, which focused on tropical forests for the next two decades.

Approximately since 10 years it is known that also trees in the temperate zone harbour a diverse and abundant fauna of arthropods. For example, in 705 fogging samples from individual tree crowns in Europe the number of free living arthropods varied between some hundred and 40.000 specimens (Floren, own data). Extrapolating these numbers to a single hectare of mixed deciduous European forest resulted in a conservative estimation of at least 1 million arthropods living in the canopy (Floren, 2008). These numbers alone suggest that the canopy fauna is of large importance for ecosystem processes and can not be neglected when analysing biotic interactions, energy fluxes etc., although this is still often praxis (Ellenberg *et al.*, 1986; Floren & Schmidl, 2008).

New and adopted methods were required and developed during the last years (Basset *et al.*, 2003b). Probably most often used are eclectors, flight interception traps and canopy fogging. The advantage of the fogging lies first in a semi-quantitative collection of arthropods that move on leaf and branches and second in a much better chance to assign the collected species to a particular tree allowing to picture the tree specific fauna with hitherto impossible accurateness (Sprick & Floren, 2007; 2008). The results of the different methodical approaches are difficult to compare because eclectors and flight interception traps collect only few specimens per day and need to be installed several months in order to get a representative faunistic sample (e.g. Floren & Schmidl, 2003; Müller *et al.*, 2008).

2. The operating mode of the fogging machine

As its very name indicates, insecticidal knockdown uses an insecticide as a killing agent, which is applied in the tree crown by a special fogging machine.

The machine itself is rather simple and easy to handle: a fuel-air mixture is ignited in a combustion chamber generating a gas column in the resonator pipe, which oscillates ca. 90 times per second. The insecticide is injected at the end of the pipe and dispersed into fine droplets of less than 10 micrometers (Fig. 1). Because the fog is warm and expels with high velocity it raises high enough to penetrate the canopy of temperate European trees.

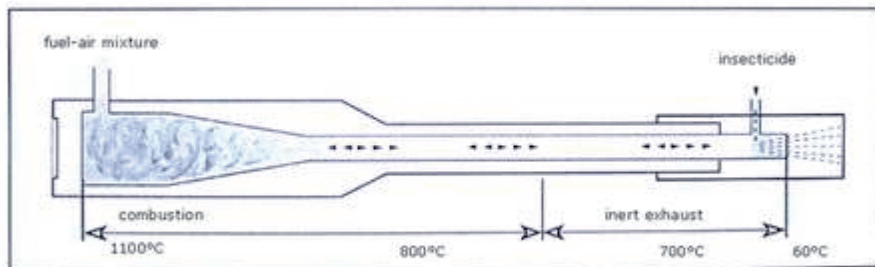

Fig. 1. The fogging machine (here an SN-50, operating manual SN-50, Swingtec GmbH, Germany) and its mode of operation.

The fogging machine is very loud (even when a noise protection device is used) and ear muffs are a must for anyone. Moreover, the machine is getting hot during fogging and often the burned patterns on the forearms of student helpers document their participation at a fogging project.

A one millimeter diameter of the nozzle through which the insecticide is injected produces a thick fog (Fig. 2) without depleting the fuel tank too quickly, allowing fogging several trees. During fogging the machine is usually held upwards. This, however, prevents a continuous fuel supply finally resulting in a disquietingly operating machine until it extinguishes. If this occurs, the expelled fuel-oil mixture inflames at the hot exhaust.

2.1. Insecticide and carrier substance

The insecticides used in fogging studies are mostly synthetical pyrethroids (e.g. Permethrin), which derive structurally from pyrethrins the main components of natural pyrethrum (NP). The first pyrethroids synthesized were photosensitive and broken apart by sunlight quickly. Therefore, pyrethroids became economically successful only after the development of photostability. Pyrethroids are contact poisons and characterised by a high knockdown – but a low knockout capacity. They were designed to replace organochlorine pesticides, organophosphates and carbamates, which are toxicologically and ecologically much more hazardous (Fromme, 2005). They persist in the ecosystem for several weeks but do not accumulate in the food web (Forth *et al.*, 2005).

Chemically, pyrethroids are esters derived from chrysanthemic and pyrethroic acids and an alcohol (Schulz *et al.*, 1993, Forth *et al.*, 2005). Due to the quick metabolisation of pyrethroids synergists are added as stabilizers and effect

enhancers, like Piperonylbutoxid (PBO), which inhibits the enzymatic metabolism in the arthropod. PBO itself is not toxic for insects and toxicity for mammals is low (Perkow & Ploss, 2007). The insecticide is usually diluted in diesel oil, which also contains synthetic additives serving as a carrier substance. Highly raffinated white oil can be used instead (for example Essobayol 82). The oil also causes the good visibility of the fog allowing to visually controlling the effectiveness of the fogging (Fig. 2).

From an ecological point of view, the negative implications of synthetic pyrethroides (next paragraph) can be avoided by using NP as an insecticide. NP is an old insecticide known for several thousand of years. In the medieval times it was known as Persian- and later as Dalmatian insect powder. Its characteristic properties: it is highly specific to arthropods, lipophilic, has a low vapor, and is quickly destroyed in sunlight due to its photosensitivity. It is only little poisonous to endothermic organisms and does not affect groundwater but it is toxic to fish. Main components are Pyrethrines (ca. 40%), Cinerin (ca. 10%) and Jasmolin (ca. 5%) (Schulz *et al.*, 1993). NP is extracted from various species of dried chrysanthemums (*Tanacetum cineraifolium* (Trevir.) Sch.-Bip. and *T. coccineum* (Willd.) Grierson. (Asteraceae)). They are cultivated and harvested on a grand scale in East-Africa. The price depends on the world market but is significantly higher than the price for synthetic pyrethroids (a 16 kg drum around 1500 €).

3. Effectiveness of natural pyrethrum on arthropods and endotherms

Pyrethroids are highly effective neurotoxins. The mechanism of action requires direct contact with the arthropod and is based on the blockage of sodium movement into nerve cells via inhibition of the enzymes adenosine triphosphate and acetylcholinesterase and the gamma-aminobutyric acidA receptor (Katz *et al.*, 2008). NP is highly specific to arthropods and possesses a high knockdown capacity while simultaneously having only a low knockout capacity. Furthermore, NP is highly repellent and used to antagonize hidden living arthropods. Pyrethroids do not or little affect plant pathogenic mites and well protected scale insects (Herve, 1985). Resistance to pyrethroids was observed after widespread application in the field and is based on an overproduction of esterases and an increase of mixed function oxidase activity (Khambay, 2002; Schröder *et al.*, 2009). In humans dermal absorption over the integument is poor. Pyrethroids are most effective when inhaled but quickly destroyed by hydrolases, enzymes that are lacking in arthropods. Pyrethroids are not stored in body tissue. Acute exposure causes reddening and irritations of skin, mucosa and the respiratory passages (Forth *et al.*, 2005). Pyrethroids may cause contact allergies (Fromme, 2005). The central nervous system might be affected from chronic exposure (Erikson & Frederiksson, 1993). Using synthetic pyrethroids requires therefore the abundance of safety measures, like wearing a respirator.



Fig. 2. Applying the fogging in the field (Photos by A. Floren).

4. Dosage of the insecticide and duration of the fogging

The great dependence of the fogging method on the weather conditions is problematic. Fogging cannot be carried out during rain, when there is too much dew or strong air currency. Generally, the best time is shortly after sunrise or before sun set when there is no thermal up wind. Due to this, fogging is rarely possible during the day. Attention should be paid that some groups of arthropods are more active in late warm afternoon, what may affect the results. Depending on the local conditions fogging is applied between three to ten minutes. In order to guarantee full impact of the insecticide, the exposure time of the fog in a tree crown should be at least three minutes.

Most trees in Europe reach heights of 30 to 40 meters, which could be reached by the fog under favourable conditions (Fig. 2A, B). However, such heights are not reached when air currencies prevent the fog from rising vertically. Given such conditions, fogging should be performed in the tree crown (Fig. 2D), from large ladders (Fig. 2C), or if necessary from a larger distance so that the fog can slowly travel to the tree tops. Pointing the fogging machine along another tree trunk may serve the expelling fog to ascent a few meters higher.

A 1% concentration of the actual insecticide is sufficient to guarantee a high knockdown effect (Adis *et al.*, 1998). Very quickly, small soft skinned arthropods come down, like wasps (Hymenoptera), various groups of Diptera and Psocoptera. Spiders try to escape at their silky thread, only to end up in the collecting sheets. Larger beetles and grasshoppers can be heard dropping down still after one and a half hour following fogging. Therefore, an insect dropping time of two hours should be allowed before all specimens are collected with a fine brush and a kitchen shovel and stored in 70% ethanol. A concentration less than 1% will only numb robust arthropods temporally and they recover quickly, indicating that fogging can also be used to collect living arthropods (see Paarmann & Kerck, 1997). As some arthropods run hectically around after dropping down, the collecting sheets should be suspended so that specimens skid to the centre (Fig. 2).

Regularly it is criticized that the arthropods, obtained by fogging, are not preserved in an adequate way, because all are stored in ethanol. However, the necessity to process all samples immediately (usually several samples a day) make it impossible to treat different groups of arthropods in different ways.

Furthermore, some of the arthropods are too small to be visible and can only be sorted in the lab using a stereomicroscope. This is the only way to guarantee that all specimens will finally reach the specialist. The storage in ethanol is therefore the only feasible way when specialists are not on site to pick their favourite groups personally.



Fig. 3. Due to the high knockdown capacity of natural pyrethrum the 'insect rain' starts immediately after fogging. The fogging of this oak tree resulted in more than 40 000 arthropods (Photo by A. Floren).

5. The study area, installation of collecting sheets and tree selectivity

The ground vegetation beneath the study trees must be cleared from high vegetation. Ideally, the collecting sheets should be suspended preventing soil arthropods from entering the sheets. Thus one can avoid later discussions whether ecologically interesting species were in fact sampled from the canopy. For the same reason the collecting sheets should be cleaned after usage.

A word about the collecting sheets: while collecting funnels were round or rectangular and suspended on ropes installed above the ground at the beginning (Erwin, 1983; Stork, 1987; Floren & Linsenmair, 1997), I am using only stable plastic sheets (mainly pieces of 4 x 5 meter), which are easy to transport and quickly mounted (Floren & Schmidl, 2003). Their plain surface prevents arthropods from getting caught with their tarsal claws. The use of large plastic sheets is not only quicker but makes it also easier to cover most of the crown projection (80-90% can be achieved mostly). This is desirable in order to get a reliable subsample of the arboreal fauna. However, many studies still use only few square meters, losing most of the dropping specimens and therefore a lot of valuable information. At the sides of hills and mountains or in savannahs where wind is coming up quickly after having performed the fogging, the suspended collecting sheets must be fixed on the ground in order to prevent them from being turned upwards thereby losing all the arthropods. This method is preferred to

weighting the collecting sheets with stones or pieces of wood because in this case contamination with soil arthropods can occur.

In temperate forests tree selectivity is achieved by simply sparing out branches from neighbouring trees and exact positioning of the collecting sheets beneath the study tree. This is quite important because species abundances often allow inferring on tree specific association (Floren & Gogala, 2002; Sprick & Floren, 2007, 2008). Guaranteeing tree specificity can be a larger problem in tropical forests, however, where several species of trees can grow within a few meters. In order to exclude collecting arthropods from different neighbouring trees or trees of the higher canopy that may partly cover the crown of the study tree, I stretched out a large cotton cloth above the study tree the day before fogging in previous studies (Floren & Linsenmair, 1997). This approach has proven very efficient but the amount of work is large. Alternatively, the search time for suitable tree species is much higher and can usually be carried out only with the help of a botanist.



Fig. 4. Fogging a young tree by using a large cotton sac. (Photo by A. Floren).

The fogging can also be used to collect the arthropods from young trees or bushes. This requires to carefully installing the collecting funnels beneath the tree without causing disturbance. A cotton sac is then quickly put on the plant and the fog blown inside for a few seconds from below (Fig. 4). After shaking the tree the arthropods can be sampled a few minutes later.

6. Disturbance generated by fogging

Fogging was considered to be a mass destructive method for a long time. This negative label can be adjusted when the fogging experiment is applied professionally, including the usage of natural pyrethrum. After being applied to the tree, the fog mixes with the higher air and is quickly blown away by the wind so that already a few minutes after the application, nothing indicates that a fogging experiment was performed. During inversions, which are sometimes observed, the fog can be pushed downwards again. Such situations can look ghastly and although no harm emanates from the NP, people might feel threatened. The disturbance caused by the fogging is spatiotemporally limited and the effect of the insecticide decreases quickly with increasing distance from the study tree; already in hundred meters distance from the place of fogging specimens recover quickly (Floren & Schmidl, 2003).

The question how quickly tree specific communities recover after fogging has not gained much attraction. The few results available show a large variability; for example Stork (1991) collected only 20% of the original number of specimen after re-fogging a tree in Borneo, an effect that might be caused by the persistent insecticide, however. On the other hand approximately the same number of specimens was collected in a re-fog 10 days after the initial fog in a forest in Peru (cited after Stork & Hammond, 1997). In a more comprehensive study Horstmann *et al.* (1999) found that the re-colonization of fogged trees by small Hymenoptera in a lowland rain forest of Borneo was still incomplete after periods of 7-19 month. Generally, re-fogging data vary largely indicating that the rearrangement of communities is largely unpredictable (Floren, 2003, 2008). In contrast, communities of arboreal arthropods in temperate regions with their pronounced seasonality seem not to be distinguishable from those collected in the following year.

Due to high visibility of the fog one should bear in mind to inform the local fire brigade in order to prevent a needless move out as I had experienced a few times. As there is no fire brigade in tropical regions it is all the more important to inform the people living in the surrounding area about the project and the harmless of the fog.

7. Comparability of fogging investigations

Adis *et al.* (1998) published recommendations for the standardisation of fogging experiments arguing for better comparability of data. One can assume, however, that fogging, if applied properly, produce comparable data independent whether it was carried out in the tree or from the ground or what type of collecting sheets were used. More important is the underlying question of the study. For example, are data on seasonal effects comparable with those on stratification? How did the local weather conditions affect the quality of the data etc.? Comparison of absolute numbers of arthropods (like specimens per square meter) are more difficult to interpret because species abundances depend on small scale factors, which are difficult to measure, like microclimatic conditions, differences in habitat structure etc. Furthermore, such comparisons require the consideration of tree

specific parameters like crown size, crown volume, percent leaf cover, diameter of trunk in breast height etc. Leaf cover, is of particular importance. It can be measured as the relative proportion of leaf area against the sky (Floren & Linsenmair, 1998). The standardised number of arthropods (SA) is then:

$$SA = (\text{arthropods/sqm}) * 100/\text{rel. proportion of leaf cover.}$$

A canopy community is not sampled completely by insecticidal knockdown. Indispensable failures derive from arthropods drifting away during their way down or which miss the sheets, specimens that skitter away or those that remain on the leaf or in bark crevices. One can assume to collect another 5 to 20% of arthropods when the collecting sheets remain in place until the other day (Floren & Schmidl, 2003). It must also be mentioned that fogging does certainly not sample arthropods living in epiphytes or in suspended soils, like detritus accumulations, ferns etc. (Yanoviak *et al.*, 2004).

8. Which groups of arthropods are sampled reliably?

It is not surprising that fogging collects mainly arthropods that live free in the tree, while endophytic species are undersampled (mainly species of the voluminous wooden body – stem, branches and bark – and small species that stay in bark crevices or in flowers etc.). Mites, Collembola and Thysanoptera vary greatly between fogged trees and they are certainly much more numerous than reflected in the fogging samples (references in Floren & Schmidl, 2008). As fogging is not the most appropriate method of trapping these groups, I do not consider them in community level analysis.

Time and again the question comes up whether fogging samples also large animals, like stag beetles or fast flying insects. The answer is yes, there are good-flying insects in the samples, like horseflies (Diptera), but it is not known whether they are collected quantitatively. Fogging does not sample large butterflies, simply because they are rarely found in the crowns, while small moth can be quite numerous. In this context one should consider that a fogging experiment is a brief operation and that the sampled part of the canopy is rather small reducing the chance to collect less frequent specimens.

9. Concluding remarks

Insecticidal knockdown makes it possible to collect arboreal free living arthropods in a semi-quantitative way, allowing characterising tree specific communities in their diversity, structure and dynamics. In this respect fogging is unique. Although arthropod abundance in the trees is high one can just ask as well why species do not reach even higher numbers. For example, common species, like phytophagous *Rhynchaenus fagi* (Curculionidae, Coleoptera), can be collected with more than 3000 individuals per tree, but in relation to all leaf of an individual tree this number is comparatively low, too.

While fogging was used to collect and to characterise the arboreal fauna of different trees during the last years (references in Floren & Schmidl 2008) it is applied today also in experimental research, for example to analyse

recolonisation dynamics, in predator exclusion experiments or to analyse changes in canopy communities after manipulation of resources (<http://www.biodiversity-exploratories.de>).

Following the recommendations given in this paper we can assume that canopy fogging produces a representative picture of the canopy assemblage. In Europe this requires to fog between 5 and 10 trees per tree species and arthropod groups in most cases. Tables summarising the advantages and disadvantages of insecticidal knockdown have been already published (Adis *et al.*; 1998 Stork & Hammond 1997; Basset *et al.*, 2003b). Therefore, I do not want to add another list but make the following general remarks:

- Fogging is a highly effective method of collecting canopy arthropods but one can make the best of the data only when the whole community of canopy arthropods is sampled. By doing so a surprisingly high efficiency is achieved as demonstrated by a study of canopy spiders in a SE-Asian lowland rainforest, where different forest types could be distinguished by singletons alone by using advanced statistical methods (Floren & Müller, submitted).
- One should avoid false expectations. Insecticidal knockdown is not universally applicable but has, as any other method, its pros and cons. It allows a quick characterisation of the canopy community but can not replace other approaches like selective searching for *e.g.* cryptic or endophytic species.
- Finally, it should be noted that due to the large dependence on the weather conditions a fogging experiment can not be forced and field work is more unpredictable than applying different methods.

10. Acknowledgements

This work is a summary of many years of field work and I would like to thank all involved students and colleagues. Special thanks go to Peter Sprick for valuable comments. I also would like to thank Rudy Jocqué for discussing different aspects of the MS and one anonymous reviewer for his helpful comments.

11. Recommended references

- ADIS, J., BASSET, Y. FLOREN, A., HAMMOND, P.M. & LINSENMAIR, K.E. 1998. Canopy fogging of an overstorey tree - Recommendations for standardization. *Ecotropica* 4: 93-97.
- BASSET, Y., NOVOTNY, V., MILLER, S.E. & KITCHING, R.L. 2003a. Arthropods of tropical forests: Spatiotemporal Dynamics and Resource Use in the Canopy. Cambridge University Press, Cambridge: 474 pp.
- BASSET, Y., NOVOTNY, V., MILLER, S.E. & KITCHING, R.L. 2003b. Methodological advances and limitations in canopy entomology. *In*: BASSET, Y, NOVOTNY, V., MILLER, S.E., & KITCHING, R.L. (Eds.). *Arthropods of tropical forests*. Cambridge University Press, Cambridge, 474: 7-16.
- ELLENBERG, H., MAYER, R. & SCHAUERMANN, J. 1986. *Ökosystemforschung, Ergebnisse des Sollingprojekts 1966-1986*. Eugen Ulmer, Stuttgart: 507 pp.
- ERIKSON, P. & FREDERIKSSON, A. 1993. Neurotoxic effects of two different Pyrethroids, Bioallethrine and Deltamethrine, on immature and adult mice. *Toxicology and Applied Pharmacology* 107: 78.
- ERWIN, T.L. 1982. Tropical Forests: Their richness in Coleoptera and other arthropod species. *The Coleopterist Bulletin* 36(1): 74-75.
- ERWIN, T.L. 1983. Beetles and other insects of tropical forest canopies at Manaus, Brazil, sampled by insecticidal fogging. *In*: SUTTON, S.L., WHITMORE, T.C. & CHADWICK, A. C. (Eds). *Tropical rainforest: ecology and management*. Blackwell Scientific Publications, Oxford: 59-75.
- FLOREN, A. 2003. Diversity and distribution of Diptera in the canopy of primary and disturbed SE- Asian lowland rain forests. *Studia Dipterologica* 10: 367-379.
- FLOREN, A. 2008. Abundance and ordinal composition of arboreal arthropod communities of various trees in old primary and managed forests. *In*: FLOREN, A. & SCHMIDL, J. (Eds). *Canopy arthropod research in Europe*. Bioform, Nürnberg, 576: 279-298.
- FLOREN, A. & GOGALA, A. 2002. Heteroptera from beech (*Fagus sylvatica*) and silver fir (*Abies alba*) trees of the primary forest reserve Rajhenavski Rog, Slovenia. *Acta Entomologica Slovenia* 10: 25-32.
- FLOREN, A. & LINSENMAIR, K.E. 1997. Diversity and recolonisation dynamics of selected arthropod groups on different tree species in a lowland rain forest in Sabah, Malaysia with special reference to Formicidae. *In*: Stork, N.E., ADIS, J.A. & DIDHAM, R.K. (Eds). *Canopy Arthropods*. Chapman & Hall, London: 344-381.
- FLOREN, A., & LINSENMAIR, K.E. 1998. Diversity and recolonisation of arboreal Formicidae and Coleoptera in a lowland rain forest in Sabah, Malaysia. *Selbyana* 19: 155-161.
- FLOREN, A. & SCHMIDL, J. 2003. Die Baumkronenbenebelung - Eine Methode zur Erfassung arborikoler Lebensgemeinschaften. *Natur und Landschaft* 35: 69-73.

- FLOREN, A., & SCHMIDL, J. 2008. Introduction: Canopy arthropod research in Europe. *In: FLOREN, A. & SCHMIDL, J. (Eds). Canopy Arthropod Research in Central Europe*, Nürnberg: 13-20.
- FORTH, W., HENSCHLER, D. & RUMMEL, W. 2005. Allgemeine und spezielle Pharmakologie und Toxicologie, 9th edition. Urban & Fischer, München, Jena.
- FROMME, H. 2005. Umweltmedizinische Hintergrundinformationen zu Pyrethroiden. Pages 25 in Bayerisches Landesamt für Gesundheit und Lebensmittelsicherheit. Bayerisches Landesamt, Oberschleißheim.
- HERVE, J.J. 1985. Agricultural, public health and animal health usage. *In: LEAHEY, J.P. (Ed.). The Pyrethroid insecticides*. Taylor and Francis, London, Philadelphia : 230 pp.
- HORSTMANN, K., FLOREN, A. & LINSEMAIR, K.E. 1999. High species-richness of Ichneumonidae from the canopy of a Malaysian rain forest. *Ecotropica* 5: 1-12.
- KATZ, T.M., MILLER, J.H. & HEBERT, A.A. 2008. Insect repellents: historical perspectives and new developments. *Journal of the American Academy of Dermatology* 58: 865-871.
- KHAMBAY, B. 2002. Pyrethroid insecticides. *Pesticide Outlook* 13: 49-54.
- KÜSTER, H. 1998. Geschichte des Waldes: von der Urzeit bis zur Gegenwart. C.H. Beck Verlag, Kempten.
- LINSEMAIR, K.E., DAVIS, A.J., FIALA, B. & SPEIGHT, M.R. 2001. Tropical Forest Canopies: Ecology and Management. Kluwer Academic Publishers, Dordrecht.
- MÜLLER, J., BUßLER, H. , GOßNER, M. , RETTELBACH, T. & DUELLI, P. 2008. The European spruce bark beetle *Ips typographus* in a national park: from pest to keystone species. *Biodiversity and Conservation* 17: 2979-3001.
- PAARMANN, W. & KERCK, K. 1997. Knockdown efficiency of natural pyrethrum and survival rate of living arthropods obtained by fogging in Central Amazonia. *In: STORK, N.E., ADIS, J. & DDIDHAM, R.K. (Eds). Canopy arthropods*. Chapman and Hall, London: 67-81.
- PERKOW, W. & PLOSS, H. 2007. Wirksubstanzen der Pflanzenschutz- und Schädlingsbekämpfungsmittel. Parey, Stuttgart.
- SCHRÖDER, G., PÖLITZ, B., WOLFF, C. & KRÜGER, B. 2009. Möglichkeiten der gezielten Bekämpfung von Pyrethroid-resistenten Rapsglazkäferpopulationen - Ergebnisse von Ringversuchen mehrerer Bundesländer. *Gesunde Pflanzen* 61: 19-30.
- SCHULZ, J., SCHMOLDT, A. & SCHULZ, M. 1993. Pyrethroide: Chemie und Toxikologie einer Insektizidgruppe. *Pharmakologische Zeitschrift* 15: 1141-1156.
- SOUTHWOOD, T.R.E. 1961. The number of species of insect associated with various trees. *Journal of Animal Ecology* 30: 1-8.
- SOUTHWOOD, T.R.E., MORAN, V.C. & KENNEDY, C.E.E. 1982. The assessment of arboreal insect fauna: comparisons of knockdown sampling and faunal lists. *Ecological Entomology* 7: 331-340.

- SPRICK, P. & FLOREN A. 2007. Canopy leaf beetles and weevils in the Bialowieza and Borecka forests in Poland (Col., Chrysomeloidea, Curculionoidea). *Polskie Pismo Entomologiczne* 76: 75 -100.
- SPRICK, P. & FLOREN, A. 2008. Phytophagous beetles of trees – a study based on fogging samples from primeval forests of Poland, Romania and Slovenia (Col., Chrysomeloidea, Curculionoidea). *In: FLOREN, A. & SCHMIDL, J., (Eds). Canopy Arthropod Research in Central Europe*. Bioform Verlag, Nürnberg 576: 225-260.
- STORK, N.E. 1987. Arthropod faunal similarity of Bornean rain forest trees. *Ecological Entomology* 12: 219-226.
- STORK, N.E. 1991. The composition of the arthropod fauna of Bornean lowland rain forest trees. *Journal of Tropical Ecology* 7: 161-180.
- STORK, N.E., ADIS, J. & DIDHAM, R.K. (Eds). 1997. *Canopy arthropods*. Chapman & Hall, London: 567 pp.
- STORK, N.E. & HAMMOND, P.M. 1997. Sampling arthropods from tree-crowns by fogging with knockdown insecticides: lessons from studies of oak tree beetle assemblages in Richmond Park (UK). *In: STORK, N. E., ADIS, J. and DIDHAM, R.K. (Eds). Canopy Arthropods*. Chapman & Hall, London: 3-26.
- YANOVIK, S.P., WALKER, H. & NADKARNI, N.M. 2004. Arthropod assemblages in vegetative vs. humic portions of epiphyte mats in a neotropical cloud forest. *Pedobiologia* 48: 51-58.

Chapter 9

Soil and litter sampling, including MSS

by

Teresa Domingo-Quero

Depto. de Biodiversidad y Biología Evolutiva,
Museo Nacional de Ciencias Naturales (CSIC),
José Gutiérrez Abascal, 2, E-28006 Madrid, Spain

Miguel Ángel Alonso-Zarazaga

Depto. de Biodiversidad y Biología Evolutiva,
Museo Nacional de Ciencias Naturales (CSIC),
José Gutiérrez Abascal, 2, E-28006 Madrid, Spain.
E-mail: zarazaga@mncn.csic.es

Abstract

Soil is defined, and its components, structure, types, pedogenic regimes and classifications are briefly described. Rhizosphere and MSS (mesocavernous shallow stratum) are summarized and their importance emphasized. A diagnosis of the soil fauna is given and its representative groups recorded, these being divided for practical reasons into microfauna and macrofauna. Conservation issues are briefly addressed. Sampling methods are reviewed in a comprehensive treatment, and divided into field procedures and laboratory techniques. The field methods described are: direct sampling, sifting, pitfall traps, MSS traps, slope boring and hand collecting. Laboratory methods treated are: filtering, flotation, decantation, elutriation, flotation-centrifugation, and use of Berlese-Tullgren funnels, Moczarski eclectors and Baermann funnels. Recommendations on the construction of different traps, conservation, transport and preservative preparation are also given.

Key words: mesocavernous shallow stratum, trapping, field methods, laboratory methods, conservation

1. Introduction

1.1. Definition and components

Soil, at a global scale, is a complex natural film discontinuously covering the Earth's surface that is not underwater. As with most living things, soils start, develop, mature, age and either disappear or fossilize. The peculiar chemistry of the constant presence of large quantities of water impede the formation of soils, although moderate to high quantities of water do not stop the formation of particular kinds of soils, but soil formation is never completely finished under water. Soil can also be defined as an interface between the four main components: minerals, water, air and organic matter (either living or dead), or in other words, the lithosphere, the hydrosphere, the atmosphere and the biosphere.

This mixture of gas, liquid and solid (a three-phase system) has a structure, which varies depending upon several factors: the nature of the original rock(s); their mineral component(s); the porosity of the structure and the ability of these pores to absorb gas and liquid components; the climate where the soil is developing; the biota inhabiting it; and the time all these factors have been interacting. Or in other words, its history (*pedogenesis*).

Soils are absent in some parts of the terrestrial environment: ice caps and perpetually frozen peaks. Even on bare rocks, bacteria, lichens and mosses start the gradual transformation into soil: this is called *primary succession*. Sooner or later, depending upon these factors, a complex community will develop in this growing soil (Lomolino *et al.*, 2006).

Once a soil, even if primary (*protosoil*), has been established, the further development will depend not only in the kind of protosoil, but also on climate, surrounding vegetation and time. This *secondary succession* will lead to the establishment of *climax* vegetation. The formation of a soil includes chemical processes, such as weathering of the bedrock and alluvial deposits, oxidations and reductions, hydrolysis, chelation or solution of ions, hydration, interactions with organic substances (rotting, humus formation), and physical processes (erosion), like freezing, thawing, leaching, wetting, drying, and different kinds of transportation and depositions. The biota will also help: the organisms mix soil materials and create pores that allow the lower layers to be affected by the other factors; some of them (*e.g.* plant roots, bacteria and fungi) produce substances that are freed to interact with the other soil components. The net of roots and hyphae keep the stability of soils, and create an irregular system that also stores organic matter.

Over all these factors, the main ruler is *time*. None of these processes will take place if not enough time is allowed for them to act, and for all the factors to interact. Interrupted soil forming processes will start again on the new basis created by the disturbance. These processes may be very fast or take millions of years, until a mature soil is formed.

The soil is important because of this interaction between its abiotic and biotic components, because of its action as a substratum of wild plants and crops, conveying the nutrients for the upper trophic levels in the life pyramid, and because its biota are a fundamental part of the unknown biodiversity.

The science of studying soils is known as Soil Science, and has two main branches: Edaphology (the influence of soil in living things, including man's uses - agriculture and related disciplines) and Pedology (study of soils in natural environments), although this distinction is denied by some schools.

1.2. Structure of soils

Soil is composed of layers (*horizons*). Every layer has its own peculiarities in the proportions and characteristics of the three phases. From bottom to top, the soil becomes less and less similar to the original parent rock, and the signs of interaction with the atmosphere, the hydrosphere, and most of all, the biosphere, become more and more evident.

Typically, a mature soil must have four horizons, which are separated according to colour, structure (form and aggregation of grains, porosity), texture (proportion of clay, silt and sand), consistency, rhizosphere, pH and some other characters (Fig. 1). These are called by using letters, from top to bottom, O, A, B, C. Sometimes the bedrock or parent rock in the bottom is called horizon R. Usually they are easily separable by sight and by texture.

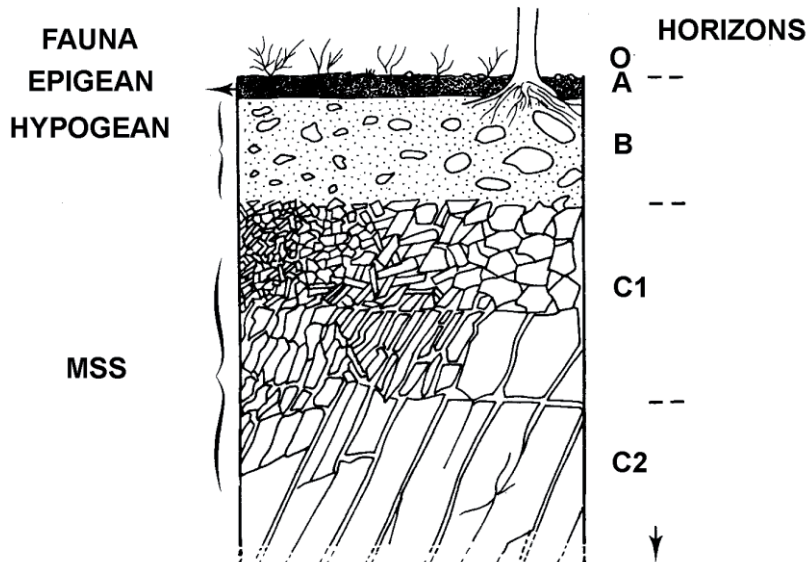

Fig. 1. Soil horizons and associated fauna (redrawn from Juberthie *et al.*, 1980b).

- **Horizon O.** This is a horizon composed of organic matter which is not yet decomposed (raw humus). It corresponds to litter in the usual meaning of this word in biology. Mineral matter is almost absent. For some authors, this layer is not a part of soil in fact, since it does not show clearly any of the processes leading to soil formation. It is usually divided into two subhorizons (from top to bottom): O₁ and O₂. The first has vegetal remains that can be recognized by sight (pieces of leaves, etc.); in the second, recognition is not immediately possible.
- **Horizon A.** This is the top layer of the “true” soil. It is usually darker in colour than lower horizons, because of the accumulation of humus (the stable colloidal, uniform, dark substance resulting from chemical transformation of the raw humus, the general organic matter of soil). This humus helps to buffer soil pH, retains water, increases the soil capability of storing nutrients, and sticks mineral grains together, thus improving the texture and structure of soil, among other valuable properties. Horizon A is also poor in clay and sesquioxides, and is where most of the biological activity takes place, so most of the organisms are concentrated here.
- **Horizon B.** This is the intermediate layer of the soil, usually containing concentrations of clay and minerals of elements like iron or aluminium, or a little organic material which arrives from above by leaching. Consequently, it is usually reddish or brownish. It is also called the “illuviated” horizon because it receives materials from above by filtering (illuviation) through horizon A.
- **Horizon C.** This is a horizon which is little affected by processes occurring in the soil, showing a poor development from the parent rock that lies below, being sometimes just a layer of (sometimes boulder-like) fragmented rock on top of it.

In some classifications, horizons D, E and P are also recognized.

The horizons B and C are also united, from a biological point of view, by the MSS (“milieu souterrain superficiel” (Juberthie *et al.*, 1980a, b) or “mesocavernous shallow stratum” (Ashmole *et al.*, 1990), also called less often “superficial underground compartment” (Juberthie & Delay, 1981) or “shallow subterranean compartment” (Howarth, 1983)) with caves and void subterranean spaces below (lava tubes, etc.). This MSS is a network of cracks and crevices, mostly in C₁, acting as corridors between the upper and the lower horizons, and into the caves, a kind of living highway for exchange of biota both horizontally and vertically, subject to seasonal temperature changes.

Another particular structure in the soil is the *rhizosphere*. This is defined as the region of soil that is immediately adjacent to and affected by plant roots, forming a boundary layer between roots and the surrounding soil (Cardon & Whitbeck, 2007). It is the interface where roots and their secretions (usually hormone-like, called *exudates*, e.g. strigolactones, or *allelochemicals*, which prevent other plants’ roots from growing), microorganisms, soil, nutrients and water interact. The soil not affected by the rhizosphere is called *bulk soil* and is poorer in organic matter and biota. Larger organisms tend to concentrate in the

rhizosphere, where they can find food easily, since the exudate attracts microorganisms and smaller fauna, and favours the growing of fungal mycelia. Plant root growth (and thus the increase of the rhizosphere) is facilitated by the burrowings of earthworms.

The rhizosphere and MSS are intimately linked, since the crevice system tends to be occupied by roots even at very great depths, and root feeders may follow them downwards.

1.3. Soil types

Soil being a complex entity, it is not surprising to learn that there are many types. However, two major factors (climate and parent rock) around the globe produce four main *pedogenic regimes*, giving rise to four major types of *zonal soils*:

- **Podzolization.** This occurs where temperatures are cool and precipitation is abundant. Even with substantial plant growth, microbial activity is inhibited causing *humus* to accumulate in the upper horizons and its soluble components to be leached to lower horizons. Illuviation also reduces cations in the soil, and acidifies it. The typical forests on these soils are coniferous forests, or sometimes deciduous temperate forests.
- **Laterization.** This happens where temperatures are warm and precipitation is heavy. In these circumstances, microbes quickly break down all organic matter, and there is no time for *humus* to accumulate. Oxides of iron and aluminium precipitate to form a hard bricklike red layer (laterite). Cations are leached with heavy rainfall, leaving behind a hard, poor and infertile soil if the tropical cover forest is cut.
- **Calcification.** This process develops in arid grasslands and shrublands with a cool to hot climate, but with a very scanty precipitation. Cations are not leached out, but they precipitate in the lower levels as a calcium carbonate rich layer (this, if uncovered, forms a rocklike layer named *caliche*). If there is enough rain, cations and other nutrients are mobilized upwards and distributed in the soil, which is highly prized for agriculture.
- **Gleization.** This is the typical process occurring in waterlogged areas, e.g. in cold and wet polar regions. The water table is very high, preventing decomposition, and accumulating acidic organic matter. Below this layer, usually a layer of bluish-grey clay (*gley*) appears, containing partially reduced iron (FeO). Nutrients are scarcely available, so the vegetation is grassy and sparse.

However, certain rock types (e.g. gypsum, serpentine or limestone) or peculiar soil conditions (like extreme acidity, or salt) may form *azonal soils*, which can appear interspersed anywhere between the main kinds and its varieties.

1.4. Classifications

There is no single classification of soils. Since the original classification of the father of edaphology, Vasilij V. Dokučaev around 1880, many systems have

been proposed. Of those still in use, some put special emphasis on the pedogenetic processes and some on the recognizable features of the soils, so these classifications are not equivalent. The most used are:

- **The French Soil Reference System.** The “Référentiel pédologique français” is based on pedogenesis (Baize & Girard, 2009) and widely used in French territories and former colonies.
- **USDA Soil Taxonomy.** This is a descriptive system based on soil morphology (Soil Survey Staff, 1999), which allows the use of identification keys (in English or Spanish) to name a soil (Soil Survey Staff, 2006). It is mostly used in the USA and surrounding areas, but it has also been adapted to other countries.
- **The FAO system.** Originally envisaged as a legend to its famous *Soil Map of the World*, it is a worldwide system, which underwent an important improvement (FAO, 1988) and includes no climatic criteria. This system was replaced in 1998 with the *World Reference Base for Soil Resources* (WRB), which is now the only international standard system adopted by the International Union of Soil Sciences (IUSS Working Group WRB, 2007).

However, many countries have developed their own classification systems, suitable to their own pedological units.

2. The soil fauna

2.1. Groups, size and distribution

Soil fauna is abundant, rich and diverse. High numbers of individuals and species belonging to all terrestrial phyla can be found here (Rotifera, Annelida, Mollusca, Tardigrada, and most of all, Nematoda and Arthropoda).

Usually Arthropoda show the highest diversity, although there are accounts showing that they are probably equalled, if not surpassed, by the Nematoda (far less studied and understood). Representatives of all the arthropodan subphyla and of all of their terrestrial classes can be found in the soil: Cheliceromorpha (scorpions, pseudoscorpions, spiders, harvestmen and mites, and other rarer groups), Crustacea (amphipods and woodlice), Myriapoda (centipedes, millipedes, and rarer groups), and Hexapoda (insects and close allies). The latter are very well represented in the soil with the orders of entognathous hexapods (considered by some to be three classes different from insects: Collembola, Protura and Diplura), and 20 out of the 26 orders of ectognathous hexapoda (true insects) (Greenslade, 1985, with the addition of Mantophasmatodea).

Nevertheless, apart from taxonomic classifications, some other kind of classifications based upon horizontal distribution or body size can be more useful for soil fauna. This classification on body size has widespread repercussions on sampling and study of the different groups. Most authors (e.g. Wallwork, 1970) (Fig. 2) differentiate three size classes: micro-, meso- and macrofauna.

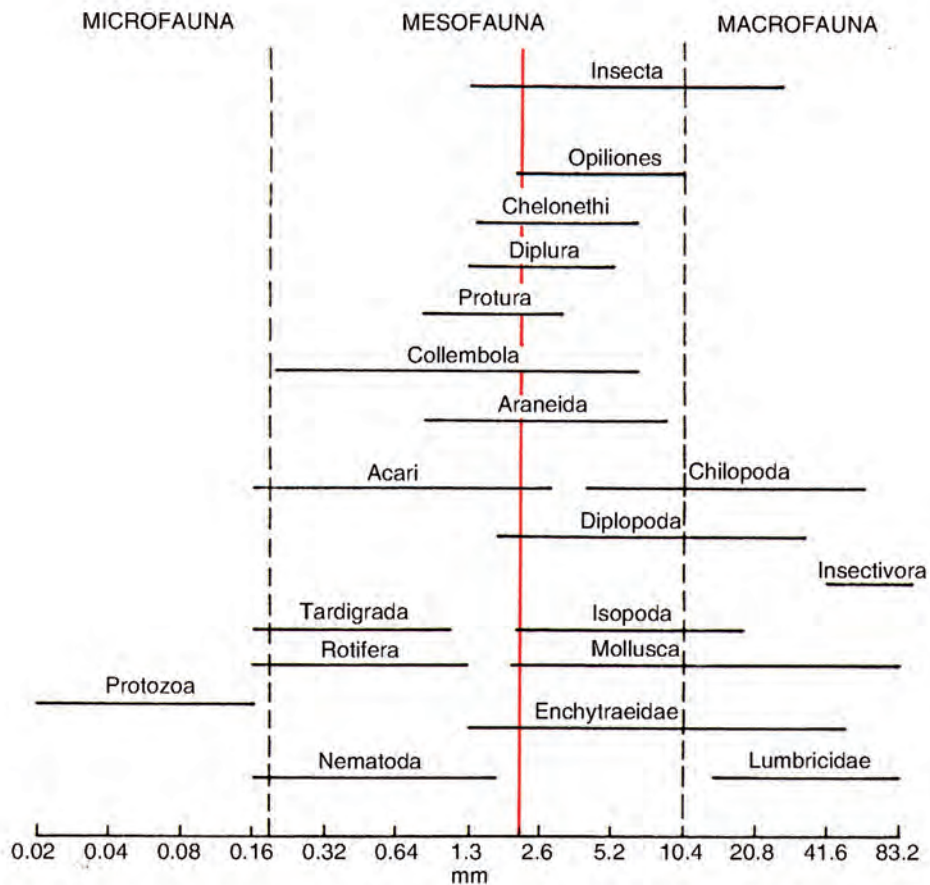

Fig. 2. Size classes in soil fauna groups, according to Wallwork (1970), modified to show the 2 mm boundary (red line).

However, there is a fundamental division in the sampling methods for microfauna and the other two groups (which will be referred to as macrofauna in the following): separating specimens under 2 mm and substratum components in the field is very difficult, when not impossible. So usually the methods intended to collect microfauna under 2 mm (Nematoda, Tardigrada, Collembola, Acari, etc.) the size of which is equal or less than the soil grain, are '*blind*'. This small size does not allow the collector to make a separation of the sample into its faunal and non-faunal components *in situ*, so it must be carried "as it is" to the laboratory and processed there (see *Laboratory extraction methods*). The collector is then compelled to extract an *in toto* sample of the soil under research (containing litter, rhizosphere parts, mycelia, sifted soil, etc.) and to carry it to the laboratory.

If, however, the target is the macrofauna (earthworms, macroarthropoda, etc.), the researcher can usually separate faunal and non-faunal elements *in situ*, and carry to the laboratory only the desired specimens.

Other factors affecting the sampling are:

- **Size of the animals.** Usually, the larger the body size of the target animals, the wider the area and the bigger the sample that must be taken;
- **Dispersion of populations.** The more disperse the populations of the target animals, the wider the area to be sampled;
- **Horizontal distribution.** Usually there is a general tendency to think of two separate behavioural guilds: *epigean* (*epiedaphic*) vs. *hypogean* (*hypoedaphic*, *endogean*, *subterranean*) faunal components (the first as walkers or crawlers on ground surface, the last either as burrowers or diggers under the surface, or as crevice or cave dwellers). But this difference is blurred by the existence of both daily and seasonal vertical migrations. They are very important in places where the diurnal and nocturnal temperatures are extremely different, or where wet and dry seasons alternate. Depending upon the sampling targets, precautions must be taken to avoid, estimate or measure these impinging factors. It must not be forgotten that soil also acts as a *refugium* for animals that feed or perch above ground (mostly at night). *Hypogean* elements can be divided into those living buried (usually either burrowing or moving along crevices), those which are true soil dwellers (*edaphobionts*, *edaphobites*), and those living in underground spaces much larger than their own size, like tunnels, caves, lava tubes, etc. (*troglobionts*, *troglobites*). In some groups, like Arthropoda, the adaptations shown by either of these two *hypogean* guilds are quite different; it is also relatively common to find *edaphobionts* invading (and being collected in) the habitats of the *troglobionts*, but not the reverse. Other authors (e.g. Jennings, 1985) distinguish between *endogean* and *hypogean* elements, being the first those “pertaining to the biological domain immediately beneath the ground surface *i.e.* in the soil or plant litter” and the second, those “pertaining to the domain below the endogean, including the dark zone of caves”. As mentioned above, these differences are not essential.

2.2. Importance and conservation

Edaphic flora and fauna are very important for life on Earth. The living component of soil is the one carrying out the numerous functions taking place in it, among them, the recycling of nutrients. For a good functionality of the soil, its fauna must be appropriately conserved.

Moreover, from an anthropocentric point of view, the edaphic fauna performs some of the commonly called “nature services”. For example, predators (spiders, ground beetles, etc.) are fundamental to keep possible pests under control in agrosystems (Goehring *et al.*, 2002, Duan *et al.*, 2004). They have even been used in developing integrated control strategies against pests (Juen & Traugott, 2004), or in measuring the success in restoring prairie ecosystems (Peters, 1997), tropical forests (Jansen, 1997), riverside forests (Williams, 1993) or coastal vegetation (Longcore, 2003), among others.

At the same time, some species play a key role in ecosystems. For example, dung beetles (Scarabaeinae) are the primary decomposers par excellence. If for

any reason their abundance decreases in a prolonged way, the decomposition rate of the organic matter will decrease as well (Klein, 1989). As a consequence, nutrient recycling in the soil will become slower, soils will become impoverished and plant communities will become fragmented; with some other unpredictable imbalances appearing as well (Goehring *et al.*, 2002).

Unfortunately, negative factors affecting the soil fauna are numerous: fires, desertification, erosion, abusive agricultural management, urbanization, contamination with pesticides and heavy metals, etc. These disruptions may cause serious imbalances in soils and provoke an irreversible loss of biota. Because of this, we must pay much attention to the high species- and community-richness inhabiting soil, if we want to conserve the terrestrial ecosystems.

Nevertheless, there is great ignorance of the taxonomy and the biology of many soil groups of taxa. For example, there is information about only 10% of the microarthropodan populations in soil and only a 10% of its species have been formally described (André *et al.*, 2002). To overcome this impediment, we must increase the effort to study the edaphic fauna, among other things.

3. Sampling methods

When a biological inventory is to be done, the first assumption that must be made is that it is not possible to collect all the species that are present in the target area (for example, Gotelli & Colwell, 2001), even more when the study focus on hyperdiverse and poorly known taxonomic groups (Colwell & Coddington, 1994).

This impediment may oblige evaluation of the collected samples and relativization of the observed richness to be able to make meaningful comparisons. Keeping this in mind, it will be very useful to undertake sampling in a methodical way and to quantify the invested effort.

Soil zoology has tried for a long time to find a sampling method that allows collection of the greatest fraction of fauna as possible. However, there is now a growing general agreement that a method allowing a good sampling of one community of species may fail for other communities (Southwood & Henderson, 2000). Thus sampling protocols combining different methods must be established if maximal efficacy of sampling is to be achieved.

The selection of the methods most suitable to the objectives must be exhaustive when trying to delimit the inventory, both taxonomically and in relation to soil horizons. Thus, the order of decision should be first the horizons and then the taxonomical or functional groups to be studied and after this, a second decision on the most suitable sampling methods is to be reached, taking into consideration the other factors affecting sampling, like body size of the target group and its distribution (see above).

With all this in mind, the next sections will treat in order the most general methods first (allowing the capture of a wider set of taxa), following with those

specifically fitted to sample particular horizons (MSS samplings), and ending with the most usual extraction techniques to be done in laboratories.

3.1. Field techniques

This section includes the methods used to collect in the field the target fauna or to collect the 'blind' soil samples to be carried to the laboratory for extraction.

3.1.1. General field techniques

These general field techniques allow the capture of a wide set of taxa. Even if the research sampling is focused in a very specific group of animals, it is desirable and highly recommended to use some of these as a tool for 'completing' the inventory.

Direct sampling

This is the basic sampling method. The researcher will locate and capture the target fauna searching for the specimens in their habitat by eyeing the ground, turning stones, searching among litter, digging around plant bases, etc. This method usually allows the capture of macrofauna only. As an exception, smaller individuals may be collected with magnifying glasses and brushes.

This method allows the sampling of the upper horizons of the ground. However, it can also be used when sampling underground inside caves, etc. In this case, it is convenient to introduce some plant matter at the first visit, and check it for specimens in subsequent visits.

In any case, direct sampling is essential if a reliable inventory, containing at least 80% of the species present in the target area, is to be realised. It allows the inclusion of the species that cannot be collected under other protocols in the inventory, which is thus completed with the rarest species, the most difficult to collect just by chance. The collecting success using this method is heavily dependent on the collector's experience and training (pers. obs.).

When using this kind of sampling, special attention must be paid to the collecting habitats. This valuable information must be included in data labels, together with other data, such as locality, date, altitude, etc. This will increase the knowledge about the biology of the target taxonomic group and will raise the probability of collecting the rare species.

Even in this kind of sampling, it is convenient to use sampling units in a systematic way, measuring allotted time, sampled area, energetical effort and other factors that may influence the results. In many studies, the unit of effort measurement is a search of 15 min. However, trained collectors should estimate whether more units are needed to give a satisfactory result of the biodiversity of the target area. If there is a suspicion that a single unit is not enough, sampling with a different number of units should be previously carried out to ascertain the most profitable set. A previous estimation of the aggregation of the populations may be also important for design (Zhou & Griffiths, 2007).

Sifting methods

Usually, sifting methods are used for the study of epigeal and litter macrofauna. A sample of litter and the first centimetres of soil is sifted using sieves of different mesh, so that two (or more) fractions are obtained *in situ*; a finer one, smaller than the mesh used and a larger one. Either of both fractions can be discarded if they are of no interest for the research; the grosser fraction can be checked *in situ* to notably reduce the volume of material to be carried to the laboratory, as the finer one usually is. Sifting thus allows the separation of the macro- and the microfauna.



Fig. 3. Winkler-Wagner elector ready to be used in the field (© MNCN; photographer: Manuel Sánchez-Ruiz).

One of the usual devices used for this purpose in entomological research is the Winkler-Wagner elector (Fig. 3), described for the first time by Holdhaus (1910). In the case of extraction of microfauna, it is usually coupled with the Berlese-

Tullgren method or with the Moczarski eclector (see below the section *Laboratory extraction methods*). In summary, a Winkler-Wagner eclector is a funnel in strong cloth like sailcloth or similar, ca. 80 cm in length, 30 cm in diameter in the widest opening and 10 cm in diameter in the opposite opening. This narrow opening must have some kind of tight closing device, like a cord or rope to be tied around. The wider opening is circled with a metal ring and a handle at right angles (more or less like a frying pan) fit to be held with the left hand. Some 25 cm below the wider opening, a second ring with another handle will be placed, but this will have inside a flat steel sieve with a mesh as required (usually 2 mm). The handle should be prepared to be held with the right hand (beware left-handed people of swapping handle orientation in both rings!). Handles should make an angle of ca. 80°. The procedure entails placing a sample of soil and litter in the upper part of the Winkler-Wagner eclector and, while keeping the upper ring still, the second ring will be vigorously shaken. After a given time for this treatment, the upper gross fraction that did not pass through the sieve will be placed on a light colour (white, pale yellow, cream) cloth under the sun and extended with the hands to create a thin layer. Specimens fleeing from heat and drying will be directly detected and caught by using fine brushes, forceps, entomological aspirators, or the hands. The fine fraction can be treated in the same way, placing it on the opposite side of the cloth under the sun. Otherwise, the finer fraction can be placed in a dark plastic bag to be transported to the laboratory, where an adequate extraction method will be selected and applied to it. Sample sizes are dependent of the above mentioned factors: Longino *et al.* (2002), in a survey of ants in a tropical forest, extracted samples of 6 l each and sifted them using the Winkler-Wagner eclector, while they collected 1.7 l samples to be directly placed in Berlese-Tullgren funnels in the laboratory. Anderson & Ashe (2000) recommend for obtaining leaf litter beetles the sifting of litter until 4.5 l of fine fraction is obtained and transported to the laboratory, where it could be divided into 3 equal portions of 1.5 l each, and placed in separate Berlese-Tullgren funnels or Moczarski eclectors. For other types and methods of use, Besuchet *et al.* (1987) can be consulted.

Pitfall traps

Purpose and design

Pitfall traps are containers buried with their rims level with the ground surface (Fig. 4). They are gravity collectors and used in general for sampling the epigeal fauna, walking or crawling on the ground surface. However, they have also been used to sample hypogean fauna, placing them inside caves or excavations in slopes (Fig. 5). Although they are purpose-built for macroarthropodan collecting, they allow collection of a wider set of taxa belonging to different trophic levels and habitats. They have been used with success in monitoring the small mammal, amphibians and reptile diversity in temperate and tropical forests (*e.g.* Santos-Filho *et al.*, 2008; Lehmkuhl *et al.*, 2008; Lima & Junca, 2008), with appropriate modifications.

Pros and cons

Pitfall traps have been used in a wide variety of studies because of their obvious, numerous advantages. They are cheap, simple to construct, use and maintain, and provide an efficient relation between number of captures and invested field collecting effort. Even so, they show several constraints, based on the fact that the obtained data do not have to reflect the actual structure of the sampled communities (Fabricius *et al.* 2003). Although this inconvenience is also shown by many other sampling methods, the generalized use of pitfall traps makes that their disadvantages take on special significance. According to Topping & Sunderland (1992), almost 40 % of the studies that used pitfall traps did not take into account this constraint in their interpretation of results, and therefore they obtained erroneous conclusions based on the absolute values of the captures.

It has often been mentioned that pitfall traps measure “surface activity”, a complex parameter in which size, activity and abundance interact, so that these traps, in fact, do not sample the faunal composition of a site (M. Morris, pers. comm.).

Some authors (*e.g.*: Luff, 1975; Topping & Sunderland, 1992) have looked at the factors causing biases and at the measure in which these distort the collecting. Thus, for example, Mommertz *et al.* (1996) point out that the factors affecting efficiency of pitfall traps can be divided in:

- **Those related to the trap characteristics.** These are: diameter, material, preservatives and baits, disturbance.
- **Those related to the sampled habitat.** These are: composition, structure and properties of the soil.
- **Those related to the specific characters of the target species.** These are: body size, activity, “capturability”.

The next section will study how trap design (container depth, rim diameter, preserving liquids and baits used, distance among trap units, etc.) can affect the efficiency of collecting, since these are the only factors (*i.e.*, first type) the researcher can modify according to his/her needs.

Variety in design

As mentioned above, the efficacy of this method depends of many factors, among these the design and the disposition in the field of the pitfall trap units (Weeks & McIntyre, 1997). Consequently, there are as many design as studies. When very particular objectives are pursued, these designs may even become very specific: *e.g.*, time-sorting traps, directional traps or ramp traps.



Fig. 4. Pitfall trap from outside, ready to work, showing its rim flush with the ground surface and ethylene glycol solution inside (© MNCN; photographer: Antonio Sánchez-Ruiz).

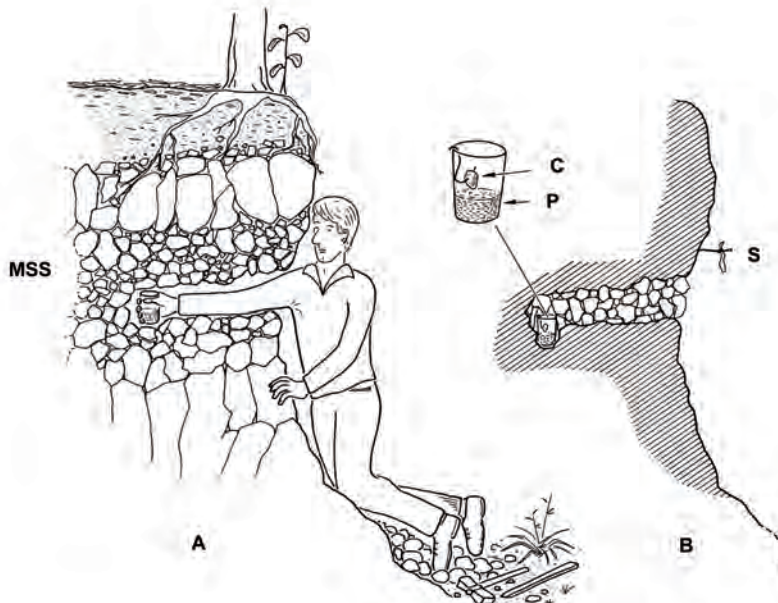

Fig. 5. Trapping by slope boring (redrawn from Machado Carrillo, 1992). A. Placement of the trap in the MSS after making a hole in the slope. MSS = mesocavernous shallow stratum. B. Final position of trap after blocking the hole. C = cheese for bait. P = preservative. S = signal for retrieving the trap.

Trap units can be disposed in different kinds of arrays depending upon the hypothesis to be tested. A usual one is difference in attractant or repellent efficiency, or interferences. They can be arranged in rows along a transect, or in square plots, or in other ways, changing trap diameter, number, spacing and layout as variables. Descriptions of complex arrays can be found elsewhere (e.g. Collett, 2003).

However, pitfall traps have also been modified for its use in answering more complicated questions:

- **Directional traps.** An array separated with drift fences to sample either a larger area or the direction of animal movement (upon design) (Hossain *et al.*, 2002; Juen & Traugott, 2004).
- **Time-sorting traps.** A complex array inside a box where a timing device exposes to the collecting funnel one container every so often. It is used in ecological studies of soil fauna activity (Blumberg & Crossley, 1988) (Fig. 6).

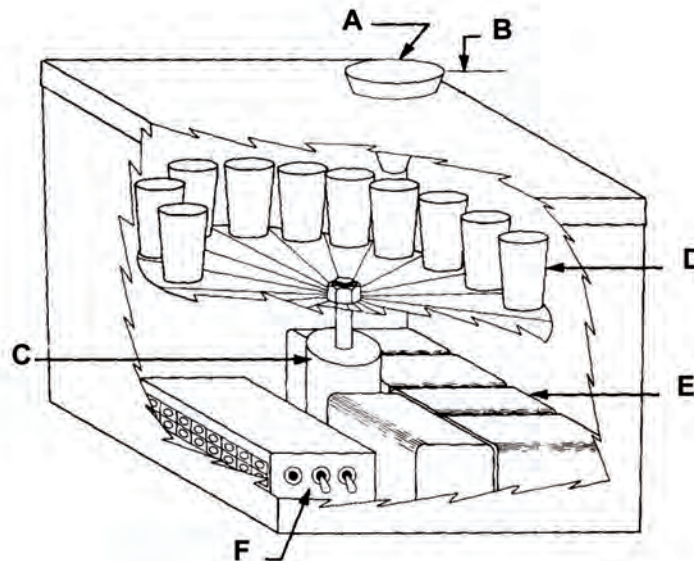

Fig. 6. Diagram of a time-sorting trap, redrawn from Blumberg & Crossley (1988). A = funnel. B = ground surface. C = rotary stepping solenoid. D = containers. E = batteries. F = timing circuit.

- **Barber trap.** Originally, this was a stone-covered and grill-baited pitfall. Barber tested different preservatives and discarded those containing acetic acid and ethanol, because of their deterring effects. He used Galt's solution mixed with ethylene glycol or glycerine, or ethylene glycol alone (Barber, 1931). In subsequent years, this term has been used for any kind of pitfall trap, but particularly for uncovered pitfall traps with three elements: an outer large receptacle, an upper wide funnel and an inner container with preservative (Fig. 7).

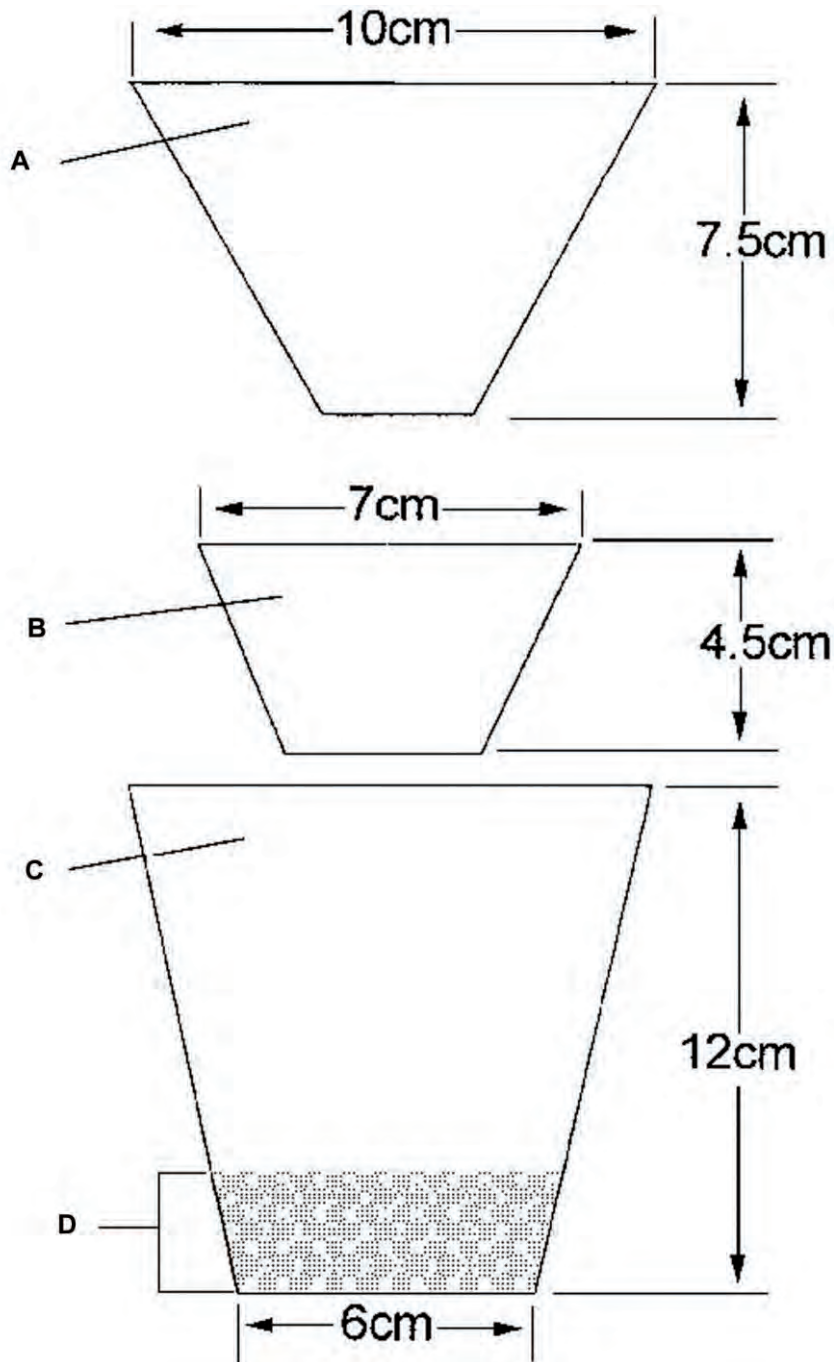

Fig. 7. Uncovered Barber style trap, according to Weeks & McIntyre (1997). A = funnel. B = inner container. C = outer container. D = preservative.

- **Ramp pitfall trap.** Used for sandy, stony or hard substrata where no digging is advisable. The trap is placed on the substratum and has ramps climbing to the rim (Bouchard & Wheeler, 2000).
- **Special-purpose traps.** There are several types. Perhaps the most well known is the Nordlander trap, originally designed for capturing weevils (Nordlander, 1987) and later used for capturing ants (Higgins & Lindgren, 2006).

Materials, shapes and collecting perimeter

Collecting containers are usually made of plastic nowadays, this being a very resistant material, although glass is also used when it is desirable to avoid climbing species from escaping from the trap, plastic being usually less polished than glass. Other authors use aluminium (Bellocq *et al.*, 2001). When the design uses a receptacle where the collecting container is fitted in, other materials can be selected for the former, like metal (Bess *et al.*, 2002) or PVC (Collett, 2003), but in the case of inverted truncated cone containers (beaker cups), it is best to use another of the same kind (Witmer *et al.*, 2003). Usually the containers are deeper than wide at rim, but the contrary is also found in the literature (Bellocq *et al.*, 2001; Bellocq & Smith, 2003).

Almost all the studies use containers with a circular section, but sometimes they can have other kind of section (square, for example, in Bellocq *et al.*, 2001). However, even if trap diameter is used as a token of their overall size (even if it is not the same along non-cylindrical containers, it is to be understood as rim diameter), the most influential dimension for capture efficiency is rim perimeter.

In the examined literature, the diameter of the container ranged between 18 and 210 mm (Collett, 2003; Verdú *et al.*, 2000, respectively). Although most of the works do not justify the use of any specific diameter, most of the studies usually used traps with a diameter between 70 and 115 mm. However, Collett (2003) expressly recommends traps of 18 mm in diameter to avoid flooding during storms while still capturing the largest arthropods. Majer (1978) recommends this diameter as well, for the same reasons, and uses a digging method minimizing the so-called '*digging-in effect*' (see below). However, this rim diameter, which can be enough for large arthropods in cold or temperate areas, may be grossly inadequate, *e.g.*, for the largest walking beetles in warm and tropical areas.

Installation, layout and distance between trap units

Traps are placed by digging or drilling a hole of the appropriate depth and width in the selected ground. The container is placed inside the hole and the ground around is fitted to the container rim. It is convenient to interfere as little as possible in the soil qualities (physical, chemical, structural) around the trap unit, not only during the installation, but also when collecting the sampling results, avoiding excessive trampling. Traps must be handled with care (Ruano *et al.*, 2004), avoiding preservative spillage and soil and litter destructuring by trampling



Fig. 8. Placement of inner beaker cup container with killing-preserving liquid inside an outer similar container (© MNCN; photographer: M.A. Alonso-Zarazaga).

and repeated digging (Goehring *et al.*, 2002). Most of these problems are avoided by using an outer receptacle (Fig. 8) for the container (Witmer *et al.*, 2003, Thomas & Marshall, 1999, Weeks & McIntyre, 1997). The receptacle will serve to keep the soil in place when the container is being extracted, saving time during container replacement and rim levelling. In places where trap flooding by rain is frequent, this receptacle can be prepared to act as a water drainage system (Collett, 2003). The 'digging-in effect' is the disturbance in the collecting efficiency of a trap after the installation. To avoid this undesirable effect, some time must be allowed to go by, before reliable samples may be collected. This period fluctuates between one (Gibb & Hochuli, 2002) and two weeks (Collett, 2003). Data obtained from samples collected during this period must be carefully considered.

In most studies, a lid is placed some 3-5 centimetres above the rim of each trap unit. This will prevent the evaporation of preservative and the entrance of water and debris (Bess *et al.*, 2002), but it also acts as an attracting shelter for specimens (pers. obs.). The lid may consist of a white plastic plate (Borges & Brown, 2003) or a small tin roof (Mommertz *et al.*, 1996) or a ceramic tile (Bess *et al.*, 2002) separated from the ground by small pieces of wire, nails, etc., or of a handier one, just a stone enough large to cover the rim with the underside rather flat, placed on three smaller ones (Domingo-Quero *et al.*, 2003). It is always convenient to use topped traps, unless the lid may hinder the capture of the target group somehow (for example, Orthoptera).

Traps may be placed single or in arrays, functioning as a single complex trap. There are many criteria about the layout of the traps, either as units or as arrays. Some authors plead for a random placement (Goehring *et al.*, 2002; Mathews *et al.*, 2004; Witmer *et al.*, 2003), or in linear transects (Borges *et al.*, 2005), in the corners of predetermined plots (Bellocq *et al.*, 2001) or in specific layouts (Juen & Traugott, 2004; Perner & Schueler, 2004).

Another parameter influencing as well the abundance, the richness and the composition of the collected fauna is the distance between traps or arrays. Thus the election of a particular distance must avoid interferences and maximize the efficiency of each trap unit. Many authors do not pay much attention to this point; however, some use or recommend a minimum separation of 7.5 (Bellocq *et al.*, 2001), 10 (Samu & Lövei, 1995; Bess *et al.*, 2002), 20 (Longcore, 2003), 25 or even 30 m (Albajes *et al.*, 2003). Although these distances may be adequate for the sampling of many macroarthropods, distances can be reduced or widened according to the presumed size of the feeding or foraging area of the target fauna.

Sample preservatives

Traps can be set dry (*live traps*) without preservative or bait, making at least a bottom hole for drainage. They are suitable for trapping living animals, but they must be tended frequently (every 24 h or less), since animals may attack each other, or may escape, or in some cases, trapped females may attract big numbers of males overflowing the trap. They are also used in arrays as a control trap unit.

Usually, traps are provided with a killing-preserving agent (usually a liquid) and called *wet traps* or *kill traps*. There are many killing-preserving agents: water, salt water, vinegar, ethanol, propylene glycol, ethylene glycol, Turquin's liquid, etc., in different purity degrees (see Appendix). All of them present pros and cons, since any single compound may result attractive for some taxonomic groups and repellent for some others. However, in general it is advisable to use some kind of killing-preserving agent, since in its absence the animals may escape or attack each other, taking into consideration the hazardous effect of most preserving agents (Weeks & McIntyre, 1997) (see Appendix). Apart from the preservative selected for the sampling, some drops of liquid detergent should be added. This additive acts as a wetting agent by reducing the surface tension, favouring the sinking of the captured specimens and avoiding thus their escape. On the other hand, several killing-preserving agents, among those considered to be more suitable, can be used at the same time. Borges (1992) recommends the simultaneous use of three of these (5% formalin, vinegar and Turquin's liquid) to capture a wider diversity of epigeal arthropods in the Azores. In arrays or pilot tests, a dry trap may serve as a test control unit.

Baits

Depending upon the kind of study and the target group, the use of some particular type of bait or attractant may be suitable. For example, for the sampling

of coprophagous or necrophagous animals, respectively a bait of excrement or of some kind of carrion (meat, squid, etc.) should be used. Other matters may also be used as attractants, like cantharidine (for some beetles), rotting fruit (for flies) or heavily scented cheese (for pitfalls placed inside caves or lava tubes) (García *et al.*, 2001), or specific feromones, among others. Attractants may be solid (and then usually placed in the middle of a wide mesh grill on top (Fig. 9) or hanging from this point, or liquid and mixed with the preservative. Some preservatives may act either as attractants or repellents for different groups of animals, and thus bias the results.



Fig. 9. Dung-baited uncovered pitfall trap for collecting coprophagous beetles (© MNCN; photographer: Jorge M. Lobo).

Sampling period and frequency

Sampling periods and frequencies should be established after analysing the results of a pilot study. To increase the collecting probability, the most favourable periods for the target fauna should be selected.

The sampling frequency will be determined by the objectives and by the project budget (*e.g.*, Marshall *et al.*, 1994). For studies in hot and dry places, collecting frequencies above once per week will allow the use of killing-preserving agents with a high evaporation degree (like ethanol or water). However, selecting frequencies below once per week will oblige to use mixtures containing liquids with a low evaporation rate (for example, ethyleneglycol or propyleneglycol) (Bess *et al.*, 2002). In the consulted literature, sampling frequency fluctuates between daily and monthly, being the most usual a collecting frequency of once every 1-2 weeks (*e.g.*, Albajes *et al.*, 2003). Weekly collectings are most versatile, materials will not decompose and enough time is allowed for mending any kind of wear in the traps, usually meteorological, animal- or human-made, etc.

Recommendations

Several experimental works (Weeks & McIntyre, 1997; Borges, 1992; Borges *et al.*, 2005) have not yet got to a single solution regarding the selection of trap size, distance and killing-preserving agent to use with pitfall traps. Even so, if the target is a complete inventory of the arthropodan fauna of an area, it is very convenient to use them combined with others. The most advisable point is to do

a pilot study before starting the project sampling. This study may give important information leading us to replace a single trap with an array (or the contrary) or a simple trap design with a more complex one, or may allow for a test of different preserving agents and collecting frequencies. However, from our experience, we recommend the following:

- 1) Use killing-preserving liquid if the sampling is not a 'capture-mark-recapture' design.
- 2) Different killing-preserving agents can be used in different trap units within the same trap array, provided the distance is enough to avoid interferences, in the same locality. Samples will be evaluated separately and will give useful information on the efficiency of the different agents used.
- 3) Standard containers with screw tops are most useful. They can be prepared in the adequate number and with the needed amount of preservative in the lab and carried to the field, where the lids will be used to cover the replaced containers and the new containers will be immediately placed instead, fitting the rims and letting them working with minimal disturbance.
- 4) In the laboratory, samples will be carefully filtered with a sieve of small mesh, avoiding the loss or deterioration of the specimens. Distilled water will be used to drag the preservative agent, and after that samples will be rinsed, placed in clean containers, with a definitive preservative liquid (usually 70° ethanol), and properly labelled.

Pitfall traps are also very useful in combination with other kinds of traps (e.g. Malaise traps, yellow pan traps, etc.) to give a most complete inventory of the fauna of a given area, as requested in ATBIs. They can be placed in different layouts (e.g., Basset *et al.*, 2004).

3.1.2. Specific sampling methods

These methods are aimed at obtaining specimens of precise horizons, communities or taxa. In this chapter, we will deal only with the active and passive sampling of the MSS, i.e., the fauna of the lower part of horizon B and of horizon C. It can be done in an active (collecting by hand samples out of these deep horizons) or passive manner (using MSS traps).

Active sampling

Active sampling can be done by quick digging to the sampling depth or by turning big stones or rocks using levers, at a depth of 20-30 cm or more. Both activities are very hard and the latter is risky of injuries as well, and must be undertaken by several people. The samples should be taken from the bottom of the turned stone (by brushing) as well as from the hole. This method yields mostly hypogean microfauna. A large amount of substrate must be collected to make sure that there is enough sampled material for the study. The fauna can be separated *in situ* by flotation (Marshall *et al.*, 1994), using water, a (better light-coloured) plastic bucket, a mug-like jar and a fine meshed sieving system or a paper filter. The procedure is as follows: fill $\frac{3}{4}$ of the bucket with water; drop the

sample into the water and stir carefully; as the specimens tend to float, the supernatant will be recovered with the mug and filtered. Once fixed by washing with 70% ethanol (and perhaps re-filtering), the material will be carried to the laboratory to be studied under the binocular.

Passive sampling

Passive sampling of the MSS include the use of vertical traps (here called *MSS traps*) and slope boring. They are aimed at obtaining edaphobionts from the MSS. In the first case, the method adopted here is a slight modification of that devised by García *et al.* (1997).

Construction of the MSS trap

The trap is made of several pieces (Fig. 10):



Fig. 10. Assembled main components of a MSS trap (© MNCN; photographer: M.A. Alonso-Zarazaga).

- **Component A.** A PVC tube 150 mm in inner diameter and 600 mm in length (of the grey kind used for pipes); its widest part is to be considered the upper rim.
- **Component B.** A resistant plastic container ca. 150 mm in diameter and ca. 1 l of capacity.
- **Component C.** Strong nylon thread or wire (not too thin).

- **Component D.** A PVC plug, of those prepared to plug pipes of 150 mm in diameter (to fit into component A).
- **Component E.** An eyebolt with eye as wide as to put a forefinger through.

Step 1: Take component A and delimit a zone between 250 and 450 mm below top rim.

Step 2: Drill holes 15 mm in diameter following a regular pattern (6-8 vertical rows around) (Fig. 11). Make sure that no burrs or other irregularities project inwards. If so, erase them with emery board.



Fig. 11. Detail of holes drilled along middle part of component A of a MSS trap (© MNCN; photographer: M.A. Alonso-Zarazaga).

Step 3: Cut transversally component B at a distance of 110 mm from bottom (better use an electric saw). Do not leave burrs or other irregularities on the rim. Erase them with a file or emery board and give the rim a slant inwards.

Step 4: Make two small opposite holes 20 mm below rim of component B, adjusted to diameter of component C.

Step 5. Make a handle in component B by using 450 mm of component C, passing the ends of the thread or wire through the holes from the outside to the inside. Place stopping knots in the inner part of component B. This handle will allow extraction of component B from within component A by pulling the handle out.

Step 6: Test that component B fits along component A and glides smoothly from bottom to top and back. Detect any irregularity in component A or B and erase them (Fig. 12).

Step 7: Screw component E in the center of the outer side of component D.



Fig. 12. Top view of component B placed in the bottom of component A of a MSS trap with handle up in pulling position (© MNCN; photographer: Miguel A. Alonso-Zarazaga).

Installation of the MSS trap

Be sure to carry all the components, plus some strong plastic bags or similar, a container with 200 ml of a hypersaturated salt water solution and some drops of washing-up liquid (killing-preserving agents, see Appendix), some strong nylon thread or elastic bands, and a soil drill 150 mm in diameter. Protecting gloves, a tape measure and a lever may also be useful.

Step 1: Find a suitable place in the area to be sampled. Drill a hole 150 mm in diameter and 550 mm deep into the ground. Try to avoid extreme disturbance of soil, digging with a spade is to be discarded. Use hand or power (electric, motor) drills. In extremely loose soil, like volcanic ones, a lever may suffice. Work may be hard and extracting stones in the drill path by hand every so often is commonplace.

Step 2: Once the hole is finished, introduce component A in it. It must stick out some 50 mm, so that the holes drilled in this component will be located between 20 and 40 cm in depth. This will be the sampled horizon. Make sure that the ground around the trap fits closely its neck.

Step 3: Pour the killing-preserving agent into component B.

Step 4: Descend component B to the bottom of component A, taking care of not spilling, its handle up (Fig. 12). Make sure that the rim of component B lies below the level of the lower holes around.

Step 5: Plug component A with component D to avoid contamination with surface fauna. Cover with a strong plastic bag or similar and tie it with nylon thread or elastic bands around the projecting end of component A, to waterproof it.

Step 6: Cover the top of the trap with vegetal matter, stones, litter or sand and gravel, depending upon the surroundings. Conceal it as well as possible.

Step 7: Make a precise note or sketch of the position of the trap (to be sure to find it later) and write down the date of installation.

Collecting the results

The MSS traps are functional over long periods of time. No collecting should be done before one month, even better three months. These traps have a “*maturation time*” after their setting, while the soil around the trap recovers its normality. During this maturation time, number and diversity of the captures will increase to a normal level. This time will be shorter or longer depending upon how “traumatic” for the soil the installation of the trap has been. These traps should be exploited during a long period of years to have a real inventory of the edaphobiont fauna moving through the MSS in a certain area.

After accessing the trap, the top will be carefully cleaned, and the bag and the plug removed, avoiding the drop of debris inside the trap. Putting a hand inside, the component B will be held by its handle, and carefully extracted. Some meters away from the trap, the killing-preserving agent will be filtered with a gauze (adding more fresh water if needed) and the captures placed in 70° ethanol. Component B will be cleaned and new killing-preserving agent will be placed. The trap will be reset as mentioned above for a new collecting period.

These traps can be flooded by heavy rain making the water table to raise close to surface, in which case most of the captures will get lost. The captured specimens may need a long wash with distilled water to get rid of salt encrusting.

Other measures can be used in constructing this kind of traps upon availability of the components, but inner diameter of component A must allow for an arm to go in. Rows of holes can be made at different depths depending upon the upper and lower depths of the MSS in a particular area for a proper sampling; however, care must be taken that the rim of component B does not lie higher than the lower holes. Anyway, deeper traps (more than 600 mm) are not advisable because of the difficulties in grasping the handle of component B and extracting it or in placing it well in the bottom.

Slope boring

This method lies in making a hole of an adequate size in a bank or slope, preferably in fresh cut ones because of public works. A suitable depth must be selected (usually 60-80 cm), always above the parent rock. A hole where an arm can be introduced has to be horizontally drilled. Natural cavities at the appropriate depths can also be used. Normal pitfall traps can be placed inside the hole (Fig. 5A).

Some attractant pieces (strongly scented cheese is very appropriate) can be dispersed inside the small tunnel or hung inside the pitfall trap, and the opening will be carefully closed and concealed (Fig. 5B). Some days later, the area will be carefully brushed out or specimens picked up by hand or aspirator first, around the trap, and this will be extracted later. A passive approach may use also baited

ramp pitfall traps, instead of normal ones. Replace the bait and the preservative, and conceal the opening again.

3.2. Laboratory extraction methods

Sampling very small animals (*microfauna*) has the disadvantage that they cannot be separated in the field. In this case, carrying samples to undergo a laboratory extraction is obligatory. According to the nature of the methods, two kinds of extractions are to be distinguished: mechanical or passive methods, and dynamical or active methods. On the other hand, samples can be manually separated under the binocular. This is a quite unusual method since it takes up too much time, however, it may help us to evaluate the efficiency of other methods, since this is very variable, and target taxon and target horizon dependent (Southwood & Henderson, 2000).

3.2.1. Mechanical or passive methods

They are based on physical principles and sample organisms do not move. The commonest are filtering, flotation, decantation, elutriation and flotation-centrifugation. Separation protocols are very variable, since every research team tends to modify them in order to adjust them to their particular needs.

Filtering

This technique may be used in combination with those mentioned below. It is used separately when the difference between the body size of the specimens and the soil grains is very wide. In the laboratory, the sample is usually suspended in water to help the filtering process. Successive filtering can be done through a series of sieves descending in mesh size and ending in a paper filter, separating thus size fractions. Motorized sieve shakers can be found in the commerce and piled in descending mesh size.

Flotation

Is a widely used technique when the specific gravity of the fauna and of the soil grains is very different. Different liquids can be used as suspension media: solutions of 25% magnesium sulphate, of sodium chloride, of 75% of zinc chloride, of sucrose or directly heptane (Southwood & Henderson, 2000). Sometimes it is needed to do a pretreatment of the soil sample if it is too clayey, by gently shaking in solutions of sodium citrate (200 g/L) or sodium oxalate (saturated solution), or if heavily clayey, with a solution of sodium hexametaphosphate (50 g) and sodium carbonate (20 g) in 1 l of water, and placed in a vacuum desiccator under reduced atmospheric pressure until desiccation, before resuspending in the flotation medium. The basic heptane protocol is as follows: Put the sample in a cylinder with flat stopper and add 1 l of 50% ethyl alcohol and 10 ml of heptane. Replace stopper and invert cylinder without shaking. Allow the heptane to rise. Repeat inversion twice. Allow the cylinder to stand for 4 h. The sediment will settle. Decant the heptane

supernatant layer into a sieve. Rinse the sieve with 95% ethanol to remove the heptane and wash the sample into a sorting dish.

Decantation

This technique lies in washing the sample several times filtering the supernatant with a 63 μm meshed sieve. It is mostly used for specimens able to go through a sieve of 1 mm mesh, mostly soil nematodes. There are several variants of this technique (Southwood & Henderson, 2000). They are considered to be less efficient than other methods, such as elutriation.

Elutriation

This technique lies in separating the organisms by washing the sample in a constant current of water. Thus the specimens, floating more or less, are swept and later filtered, while the sediment, being heavier, is kept in the bottom of the device. This method is able to process a large amount of sample in a short time. It has been used to separate pauropods and springtails but is often used to separate soil nematodes in slightly modified devices (Southwood & Henderson, 2000). The **soil washing** technique uses a washing apparatus (Fig. 13) made of a stack of two sieves (a coarse one on top of a medium one) placed over a settling can. This can has a pivoted lateral drainage that allows floating animals to pass into the Ladell can, which has a 0.2 mm fine phosphor-bronze sieve in the bottom. Its lower opening is immersed in the drainage tank, so that the water level in the tank is always slightly above the sieve of the Ladell can. When water is poured over the sample placed in the upper sieve, specimens are filtered: large animals are caught in the coarse sieve, medium sized animals in the medium sieve and small animals (depending upon mesh size) are washed to the Ladell can sieve, where they can be recovered.

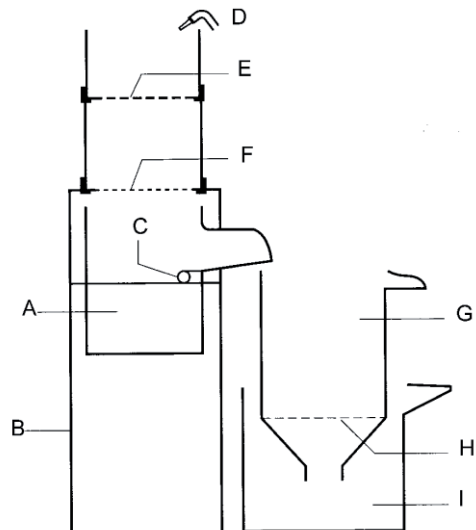

Fig. 13. Soil-washing apparatus, redrawn from Southwood & Henderson (2000). A = Settling can. B = Stand. C = Pivot. D = Nozzle of hose. E = Coarse sieve. F = Medium sieve. G = Ladell can. H = Fine phosphor-bronze gauze. I = Drainage tank.

Specifically for Nematodes, two different and widely used elutriators have been designed: the Oostenbrink and the Seinhorst elutriators.

Flotation-centrifugation

As a previous technique to this, decantation and elutriation should be used to obtain an extract of the sample. The technique in itself lies in centrifuging this extract in a saturated salt or sucrose gradient, allowing thus a final purification. This technique is not much used because it can process only a few samples at a time, but it is the election technique to extract soil nematoda and water bears in inventory studies (Coleman *et al.*, 2004).

3.2.2. Dynamic or active methods

They are based on the migration of the sample organisms as a response to the alteration of the physicochemical conditions of their environment. The most common methods are the Berlese-Tullgren funnel, the Moczarski eclector and the Baermann funnel.

Berlese-Tullgren funnel

This technique was devised for dry samples. It was originally designed by Berlese (1905) with a hot water jacket to heat the sample and posteriorly modified by Tullgren (1918) by eliminating the jacket and adding a bulb on top. After this basic design, other authors have developed more sophisticated devices, like the horizontal extractor, the high gradient extractor and the Kempson extractor (Southwood & Henderson, 2004). All of them are based in the negatively phototropic and positively geotropic behaviour of the soil fauna, which migrates downwards to fall in a collector container. The Berlese collector (Fig. 14) consists of a funnel with smooth inner surface, a lab tripod to keep it upright, a sieve fitting inside the funnel (mesh size 2 mm), a container with the appropriate killing-preserving liquid (usually 70% ethanol, added or not of up to 25% ethylene glycol; hypersaturated salt water can also be used) and a top. The sample is carefully placed in the sieve on a piece of paper and extended, then the sieve is placed inside the funnel and the debris on the paper added, the collecting container is placed below and the top covering the sieve. If the organisms sampled tend to die quickly because of drying, the environmental gradient must be soft, and the top may consist of a square gauze (square side longer than sieve or funnel diameter) with four lead weights, each sewn in one corner, and placed flat on the sieve rim; the sample will dry under the environmental conditions (Berlese model). If they are more resistant, the environmental gradient can be made harder by using a conical metal top with a light bulb inside (Tullgren model). This bulb will be on during the whole extraction process and its intensity will be determinant of the desiccation speed. These funnels can be placed in arrays and bulb tops can be powered with a single

battery or socket. It is particularly good at collecting mites, small myriapods and insects (mostly springtails and microcoleoptera) and minute spiders. According to the target fauna, the researcher can introduce particular modifications. Recca & Rapoport (1975) commented on the efficiency related to mesh size in temperate areas, observing that a 2.3 mm mesh collects only 70% of the total soil fauna, recommending instead a 4 mm mesh to be near the optimum size for collecting most of the fauna.



Fig. 14. Berlese collector formed by a sieve, a funnel, a holder and a plastic container with preservative. Leaded gauze is not shown. (© MNCN; photographer: Teresa Domingo-Quero).

Moczarski eclector

This eclector is constructed in a similar way to the Winkler-Wagner one and is widely used in temporary labs in the field (Fig. 15) or in closets in hotel rooms while travelling. The main difference with Berlese/Tullgren funnels is that the extraction is by desiccation of the sample through the surrounding cloth, and not with an external energy source drying the sample from top to bottom. It is made of a strong cloth (sailcloth or similar), two equal square frames in wood or aluminium (ca. 38 cm), one strong hook and a (usually square) sieve of 2-3 mm mesh fitting the size of the frames. Both frames are sewn with a band of fine mosquito netting cloth. The upper frame is provided in each angle with one string, all four tied at their free end to the base of the hook. One funnel-like piece

is sewn by uniting four pieces of sailcloth cut like isosceles triangles, whose base must fit once sewn 38 cm, the longer side of the triangles being ca. 1 m.



Fig. 15. Array of MoczarSKI electors in place at a field station in Mont Nimba (Guinea). (© and photographer: Didier VandenSpiegel).

The four apices are cut and sewn round to allow its placement around the mouth of a collecting jar with preservative, placing previously a metal ring around the outside to force the opening of the cloth funnel to be smaller than that of the jar. The jar can be fastened under the funnel by placing an elastic band around the funnel apex and the jar. Four similar triangles will be sewn by their bases to the upper frame, being kept free on their sides, and can be united with a string under the hook, forming a hood, or conversely, they can be sewn by their sides and attached under the hook by a string, so it can be pulled up and down and fitted externally to the upper frame. The sieve will be placed on the lower frame and hold with small twisted plastic-coated wires. The sample will be placed on the sieve, and the elector hung in a closet bar or similar. For a more sophisticated device and other details, Wheeler & McHugh (1987) can be consulted.

Baermann funnel

This technique is devised for wet samples. The original model consisted of a glass funnel full of water, with a sieve at midlength, where the sample, wrapped in a gauze, is deposited (Fig. 16). A later modification is the addition of a lamp heating the water, which accelerates the separation process.

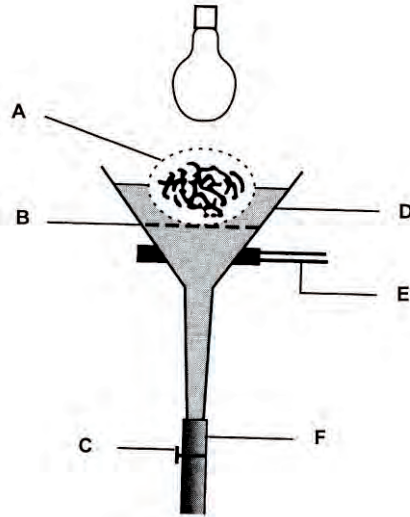

Fig. 16. Baermann funnel, redrawn from Southwood & Henderson (2000). A = muslin wrapped over sample. B = sieve. C = pinchcock. D = water. E = funnel stand. F = rubber tubing.

This technique is recommended for the extraction of animals extremely sensible to desiccation. It works well for the separation of nematodes and rotifers, but it is less advisable for that of water bears.

4. Recommendations

Sample conservation and transport

Care must be taken with the particular needs of each group for preservation and/or conservation for their later study. Most of the samples will be adequately kept in 70° ethanol at room temperature. However, with animals that must arrive alive to the laboratory, some special precautions must be taken, like trying to keep the samples in a fresh place or in a cool box and process them at once, when the laboratory is reached. If the processing should have to wait, the samples ought to be kept in a refrigerator (ca. 5°C) until this moment. If in the field the temperature and humidity conditions are unbearable for the fauna being collected, the quick use of a cool box is absolutely necessary.

Anderson & Ashe (2000) recommend the use of cotton cloth bags for the transport of samples to the lab, and processing them before 24 h of their collection, not exposing them to extreme variations of temperature and humidity. In general, processing in laboratory after field collection of the samples must be carried as soon as possible (Marshall *et al.*, 1994).

Another general recommendation the authors of these lines have made above is repeated here: the importance of pilot studies to help finely tune the parameters of the collection.

5. Acknowledgements

We want to thank here Dr Michael G. Morris (Dorchester, UK) for his careful linguistic correction and some valuable suggestions on our draft.

6. Recommended references

- ALBAJES, R., LÓPEZ, C. & PONS, X. 2003. Predatory fauna in cornfields and response to imidacloprid seed treatment. *Journal of Economical Entomology* 96(6): 1805-1813.
- ANDERSON, R.S. & ASHE, J.S. 2000. Leaf litter inhabiting beetles as surrogates for establishing priorities for conservation of selected tropical montane cloud forests in Honduras, Central America (Coleoptera; Staphylinidae, Curculionidae). *Biodiversity and Conservation* 9: 617-653.
- ANDRÉ, H.M., DUCARME, X. & LEBRUN, P. 2002. Soil biodiversity: myth, reality or conning? *Oikos* 96(1): 3-24.
- ASHMOLE, M.J. & ASHMOLE, N.P. 1987. Arthropod communities supported by biological fallout on recent lava flows in the Canary Islands. *Entomologica Scandinavica Supplementa* 32: 67-88.
- ASHMOLE, N.P., ASHMOLE, M.J. & OROMÍ, P. 1990. Arthropods of recent lava flows on Lanzarote. *Vieraea* 18: 171-187.
- BAIZE, D. & GIRARD, M.-C. (Eds). 2009. *Référentiel pédologique 2008*. Association française pour l'étude du sol. INRA. Éditions Quae, Paris: 480 pp.
- BARBER, H.S. 1931. Traps for cave-inhabiting insects. *Journal of the Elisha Mitchell Scientific Society* 46: 259-266.
- BASSET, Y., MAVOUNGOU, J.F., MIKISSA, J.B., MISSA, O., MILLER, S.E., KITCHING, R.L. & ALONSO, A. 2004. Discriminatory power of different arthropod data sets for the biological monitoring of anthropogenic disturbance in tropical forests. *Biodiversity and Conservation* 13: 709-732.
- BELLOCQ, M.I. & SMITH, S.M. 2003. Convergence in arthropod assemblages with various restoration approaches for Canadian deciduous forests. *Journal of Insect Conservation* 7: 99-109.
- BELLOCQ, M.I., SMITH, S.M. & DOKA, M.E. 2001. Short-term effects of harvest technique and mechanical site preparation on arthropod communities in jack pine plantations. *Journal of Insect Conservation* 5: 187-196.
- BERLESE, A. 1905. Apparecchio per raccogliere presto ed in gran numero piccoli Artropodi. *Redia* 2: 85-89.
- BESS, E.C., PARMENTER, R.R., MCCOY, S. & MOLLES, M.C.JR. 2002. Responses of a riparian forest-floor arthropod community to wildfire in the middle Rio Grande Valley, New Mexico. *Environmental Entomology* 31(5): 774-784.

- BESUCHET, C., BURCKHARDT, D.H. & LÖBL, I. 1987. The "Winkler/Moczarski" eclector as an efficient extractor for fungus and litter Coleoptera. *The Coleopterists Bulletin* 41(4): 392-394.
- BLUMBERG, A.Y. & CROSSLEY, D.A.JR. 1988. Diurnal activity of soil-surface arthropods in agroecosystems: Design for an inexpensive time-sorting pitfall trap. *Agriculture, Ecosystems and Environment* 20: 159-164.
- BORGES, P.A.V. 1992. The relative efficiency of formalin, vinegar and Turquin in pitfall traps on an Azorean pine woodland area. *Boletim da Sociedade Portuguesa de Entomologia* 1 (Suplemento 3): 213-223.
- Borges, P.A.V., Aguiar, C., Amaral, J., Amorim, I.R., André, G., Arraiol, A., Baz, A., Dinis, F., Enghoff, H., Gaspar, C., Ilharco, F., Mahnert, V., Melo, C., Pereira, F., Quartau, J.A., Ribeiro, S.P., Ribes, J., Serrano, A.R.M., Sousa, A.B., Zur Strassen, R., Vieira, L., Vieira, V., Vitorino, A. & Wunderlich, J. 2005. Ranking protected areas in the Azores using standardised sampling of soil epigeal arthropods. *Biodiversity and Conservation* 14: 2029-2060.
- BORGES, P.A.V. & BROWN, V.K. 2003. Estimating species richness of arthropods in Azorean pastures: the adequacy of suction sampling and pitfall trapping. *Graellsia* 59(2-3): 7-24.
- BOUCHARD, P. & WHEELER, T.A. 2000. Design for a low cost, covered, ramp pitfall trap. *The Canadian Entomologist* 132: 387-389.
- CARDON, Z.G. & WHITBECK, J.L. (Eds). 2007. *The rhizosphere: an ecological perspective*. Elsevier Academic Press, Burlington, San Diego, London: 212 pp.
- COLEMAN, D.C., CROSSLEY, D.A. & HENDRIX, P.F. 2004. *Fundamentals of soil ecology. Second Edition*. Elsevier Academic Press, Burlington, San Diego, London: 408 pp.
- COLLETT, N. 2003. Short and long-term effects of prescribed fires in autumn and spring on surface-active arthropods in dry sclerophyll eucalypt forests of Victoria. *Forest Ecology and Management* 182: 117-138.
- COLWELL, R.K. & CODDINGTON, J.A. 1994. Estimating terrestrial biodiversity through extrapolation. *Philosophical Transactions of the Royal Society of London (B)* 345: 101-118.
- DOMINGO-QUERO, T., ALONSO-ZARAZAGA, M.A., SÁNCHEZ-RUIZ, A., ARAUJO ARMERO, R., NAVAS SÁNCHEZ, A., SÁNCHEZ MORENO, S., GARCÍA BECERRA, R., NEBREDÁ, M., SÁNCHEZ RUIZ, M., FONTAL CAZALLA, F. & NIEVES-ALDREY, J.L. 2003. Inventariando la biodiversidad en el Parque Nacional de la Caldera de Taburiente (La Palma, Islas Canarias, España): Novedades científicas. *Graellsia* 59(2-3): 46-68.
- DUAN, J.J., HEAD, G., JENSEN, A. & REED, G. 2004. Effects of transgenic *Bacillus thuringiensis* potato and conventional insecticides for Colorado Potato Beetle (Coleoptera: Chrysomelidae) management on the abundance of ground-dwelling arthropods in Oregon potato ecosystems. *Environmental Entomology* 33(2): 275-281.

- FABRICIUS, C., BURGER, M. & HOCKEY, P.A.R. 2003. Comparing biodiversity between protected areas and adjacent rangeland in xeric succulent thicket, South Africa: arthropods and reptiles. *Journal of Applied Ecology* 40(2): 392-403.
- FAO. 1988. *FAO/UNESCO Soil Map of the World: revised legend, with corrections and updates*. Food and Agriculture Organization of the United Nations, Rome. World Soil Resources Report 60: 119 pp.
- GARCÍA, R., DOMINGO, T. & SÁNCHEZ, A. 2001. Contribución al conocimiento de la fauna cavernícola del Bejenado (La Palma, Islas Canarias) *Vulcania* 5: 39-49.
- GARCIA, R., GOVANTES, F. & MARTIN, M. 1997. *Conceptos de Espeleología Volcánica Canaria*. Ed. Cabildo de Santa Cruz de La Palma, Santa Cruz de La Palma : 118 pp.
- GIBB, H. & HOCHULI, D.F. 2002. Habitat fragmentation in an urban environment: large and small fragments support different arthropod assemblages. *Biological Conservation* 106: 91-100.
- GOEHRING, D.M., DAILY, G.C. & ŞEKERÇIOĞLU, Ç. 2002. Distribution of ground-dwelling arthropods in tropical countryside habitats. *Journal of Insect Conservation* 6: 83-91.
- GOTELLI, N.J. & COLWELL, R.K. 2001. Quantifying biodiversity: procedures and pitfalls in the measurement and comparison of species richness. *Ecology Letters* 4: 379-391.
- GREENSLADE, P.J.N. 1985. Pterygote insects and the soil: their diversity, their effects on soils and the problem of species identification. *Quaestiones Entomologicae* 21: 571-585.
- HIGGINS, R.J. & LINDGREN, B.S. 2006. The fine scale physical attributes of coarse woody debris and effects of surrounding stand structure on its utilization by ants (Hymenoptera: Formicidae) in British Columbia, Canada. In GROVE, S.J. & HANULA, J.L., (Eds). *Insect biodiversity and dead wood: proceedings of a symposium for the 22nd International Congress of Entomology*. Gen. Tech. Rep. SRS-93. Asheville, NC: USDA, Forest Service, Southern Research Station: 67-73
- HOLDHAUS, K. 1910. Die Siebetechnik zum Aufsammeln der Terricolfauna. *Zeitschrift für Wissenschaftliche Insektenbiologie* 6: 44-57.
- HOSSAIN, Z., GURR, G.M., WRATTEN, S.D. & RAMAN, A. 2002. Habitat manipulation in lucerne *Medicago sativa*: arthropod population dynamics in harvested and 'refuge' crop strips. *Journal of Applied Ecology* 39(3): 445-454.
- IUSS WORKING GROUP WRB 2007. *World Reference Base for Soil Resources 2006, first update 2007*. World Soil Resources Reports No. 103. FAO, Rome: ix + 116 pp.
- HOWARTH, F.G. 1983. Ecology of cave arthropods. *Annual Review of Entomology* 28: 365-389.

- JANSEN, A. 1997. Terrestrial invertebrate community structure as an indicator of the success of a tropical rainforest restoration project. *Restoration Ecology* 5: 115-124.
- JENNINGS, J.N. 1985. Cave and karst terminology. In MATTHEWS P.G. (Ed.). *Australian Karst Index 1985*. Australian Speleological Federation, Melbourne. 495 pp., maps.
- JUBERTHIE, C. & DELAY, B. 1981. Ecological and biological implications of the existence of a "superficial underground compartment". In Beck, B.F., (ed). *Proceedings of the 8th International Congress of Speleology: a meeting of the International Union of Speleology / sponsored by the National Speleological Society ; hosted by the Department of Geography and Geology, Western Kentucky University, Bowling Green, Kentucky, U.S.A., July 18 to 24, 1981*. Americus, Ga., U.S.A.: Dept. of Geology, Georgia Southwestern College ; Huntsville, Ala., U.S.A. 1: 203-206.
- JUBERTHIE, C., DELAY, B. & BOUILLON, M. 1980a. Sur l'existence d'un milieu souterrain superficiel en zone calcaire. *Comptes Rendus hebdomadaires des séances de l'Académie des Sciences, (D) Sciences naturelles* 290: 49-52.
- JUBERTHIE, C., DELAY, B. & BOUILLON, M. 1980b. Extension du milieu souterrain en zone non-calcaire: description d'un nouveau milieu et de son peuplement par les coléoptères troglobies. *Mémoires de Biospéléologie* 7: 19-52.
- JUEN, A. & TRAUGOTT, M. 2004. Spatial distribution of epigeaic predators in a small field in relation to season and surrounding crops. *Agriculture, Ecosystems and Environment* 103: 613-620.
- KLEIN, B.C. 1989. The effects of forest fragmentation on dung and carrion beetle (Scarabaeinae) communities in central Amazonia. *Ecology* 70: 1715-1725.
- LEHMKUHL, J.F., PEFFER, R.D. & O'CONNELL, M.A. 2008. Riparian and upland small mammals on the east slope of the cascade range, Washington. *Northwest Science* 82(2): 94-107.
- LIMA, T.M. & JUNCA, F.A. 2008. A herpetofauna de serapilheira da Reserva Ecológica da Michelin, Itubera, Bahia, Brasil. *Sitientibus Serie Ciencias Biológicas* 8(3-4): 316-321.
- LOMOLINO, M.V., RIDDLE, B.R. & BROWN, J.H. 2006. *Biogeography. Third edition*. Sinauer Associates, Inc., Sunderland, Massachusetts: xiii + 843 pp.
- LONGCORE, T. 2003. Terrestrial arthropods as indicators of ecological restoration success in coastal sage scrub (California, U.S.A.). *Restoration Ecology* 11(4): 397-409.
- LONGINO, J.T., CODDINGTON, J. & COLWELL, R.L. 2002. The ant fauna of a tropical rain forest: estimating species richness three different ways. *Ecology* 83: 689-702.
- LUFF, M.L. 1975. Some features influencing the efficiency of pitfall traps. *Oecologia* 19: 345-357.

- MACHADO CARRILLO, A. 1992. *Monografía de los carábidos de las Islas Canarias: (Insecta, Coleoptera)*. Instituto de Estudios Canarios, La Laguna: 734 pp.
- MAJER, J.D. 1978. An improved pitfall trap for sampling ants and other epigeic invertebrates. *Journal of the Australian Entomological Society* 17(3): 261-262.
- MARSHALL, S.A., ANDERSON, R.S., ROUGHLEY, R.E., BEHAN-PELLETIER, V. & DANKS, H.V. 1994. *Terrestrial arthropod biodiversity: Planning a study and recommended sampling techniques*. Biological Survey of Canada (Terrestrial Arthropods): 32 pp.
- MATHEWS, C.R., BOTTRELL, D.G. & BROWN, M.W. 2004. Habitat manipulation of the apple orchard floor to increase ground-dwelling predators and predation of *Cydia pomonella* (L.) (Lepidoptera: Tortricidae). *Biological Control* 30: 265-273.
- MOMMERTZ, S., SCHAUER, C. KÖSTERS, N., LANG, A. & FILSER, J. 1996. A comparison of D-Vac suction, fenced and unfenced pitfall trap sampling of epigeal arthropods in agroecosystems. *Annales Zoologici Fennici* 33: 117-124.
- NORDLANDER, G. 1987. A method for trapping *Hylobius abietis* (L.) with a standardized bait and its potential for forecasting seedling damage. *Scandinavian Journal of Forest Research* 2: 199-213.
- PERNER, J. & SCHUELER, S. 2004. Estimating the density of ground-dwelling arthropods with pitfall traps using a nested-cross array. *Journal of Animal Ecology* 73: 469-477.
- PETERS, J.R. 1997. Soil microarthropod possible indicators of prairie recovery (Illinois). *Restoration and Management Notes* 15: 78-79.
- PETERSEN, H.A. & LUXTON, M. 1982. A comparative analysis of soil fauna populations and their role in decomposition processes. *Oikos* 39: 287-388.
- RECA, A. & RAPOPORT, H. 1975. Wire gauze size and the efficiency of Berlese-Tullgren funnels. *Pedobiologia* 15: 330-335.
- RUANO, F., LOZANO, C., GARCÍA, P., PEÑA, A., TINAUT A., PASCUAL, F. & CAMPOS, M. 2004. Use of arthropods for the evaluation of the olive-orchard management regimes. *Agricultural and Forest Entomology* 6(2): 111-120.
- SAMU, F. & LÖVEI, G.L. 1995. Species richness of spider community (Araneae): extrapolation from simulated increasing sampling effort. *European Journal of Entomology* 92: 633-638.
- SANTOS-FILHO, M., DA SILVA, D.J. & SANAIOTTI, T.M. 2008. Variação sazonal na riqueza e na abundância de pequenos mamíferos, na estrutura da floresta e na disponibilidade de artrópodes em fragmentos florestais no Mato Grosso, Brasil. *Biota Neotropica* 8(1): 115-121.
- SOIL SURVEY STAFF 1999. *Soil Taxonomy. A basic system of soil classification for making and interpreting soil surveys. 2nd Ed.* USDA-Natural Resources Conservation Service, Washington, DC. Agriculture Handbook 436: 871 pp.

- SOIL SURVEY STAFF 2006. *Keys to Soil Taxonomy, 10th Ed.* USDA-Natural Resources Conservation Service, Washington, DC: v + 332 pp.
- SOUTHWOOD, T.R.E. & HENDERSON, P.A. 2000. *Ecological methods. 3d. Ed.* Blackwell Science, Oxford: 525 pp.
- THOMAS, C.F.G. & MARSHALL, E.J.P. 1999. Arthropod abundance and diversity in differently vegetated margins of arable fields. *Agriculture, Ecosystems and Environment* 72: 131-144.
- TOPPING, C.J. & SUNDERLAND, K.D. 1992. Limitations to the use of pitfall traps in ecological studies exemplified by a study of spiders in a field of winter wheat. *Journal of Applied Ecology* 29: 485-491.
- TULLGREN, A. 1918. Ein sehr einfacher Ausleseapparat für terricole Tierformen. *Zeitschrift für angewandte Entomologie* 4: 149-150.
- TURQUIN, M.J. 1973. Une biocénose cavernicole originale pour le Bugey: le puits de Rappe. *Comptes Rendus du 96^e Congrès National des Sociétés Savantes, Toulouse 1971, Sciences*, 3: 235-256.
- VERDÚ, J.R., CRESPO, M.B. & GALANTE, E. 2000. Conservation strategy of a nature reserve in Mediterranean ecosystems: the effects of protection from grazing on biodiversity. *Biodiversity and Conservation* 9(12): 1707-1721.
- WALLWORK, J.A. 1970. *Ecology of Soil Animals*. McGraw-Hill, London: 283 pp.
- WEEKS, R.D.JR. & MCINTYRE, N.E. 1997. A comparison of live versus kill pitfall trapping techniques using various killing agents. *Entomologia Experimentalis et Applicata* 82: 267-273.
- WHEELER, Q.D. & MCHUGH, J.V. 1987. A portable and convertible "Moczarski/Tullgren" extractor for fungus and litter Coleoptera. *The Coleopterists Bulletin* 41(1): 9-12.
- WILLIAMS, K.S. 1993. Use of terrestrial arthropods to evaluate restored riparian woodlands. *Restoration Ecology* 1: 107-116.
- WITMER, J. E., HOUGH-GOLDSTEIN, J.A. & PESEK, J.D. 2003. Ground-dwelling and foliar arthropods in four cropping systems. *Environmental Entomology* 32(2): 366-376.
- ZHOU, S.J. & GRIFFITHS, S.P. 2007. Estimating abundance from detection-nondetection data for randomly distributed or aggregated elusive populations. *Ecography* 30(4): 537-549.

7. Appendix: Preservatives

Do not forget in every case to add a few drops of liquid detergent (washing-up liquid) as a wetting agent. Uncommon preservatives have not been listed.

Ethanol. Also called ethyl alcohol or simply alcohol, it is abbreviated sometimes as EtOH. Usually used as a 70% ABV water solution, that can be obtained from the commercial absolute alcohol (95,6% ABV, azeotropic mixture) by adding to one liter of the latter 391 ml of distilled water (beware, mixing is exothermic!). It is

volatile, flammable and a psychoactive drug, and it is irritant for skin and eyes. Never use denatured ethanol for conservation purposes. Percentage of alcohol by volume (ABV) is also called *degree Gay-Lussac* (°).

Ethylene glycol. It presents differential attractiveness. A very widely used killing-preserving liquid because of its slow evaporation. The cheapest way to obtain a suitable solution is to use car coolant, reduced to 50% with distilled or soft water. However, it is an eye irritant, and toxic by oral consumption, affecting the central nervous system, the heart and the kidneys. Antidotes are ethanol (strong spirits may be used until a hospital is reached) and fomepizole.

Formalin. Pure formalin is a supersaturated solution (ca. 40% by volume) of formaldehyde in water. Commercial formalin has 10-12% methanol as a stabilizer. Its use should be discarded because of health hazard: allergenic, carcinogenic, eye and mucous membranes irritant, intoxication by aspiration provokes headaches, burning throat and difficult breathing.

Galt's solution. A mixture of 5% common salt (sodium chloride), 1% potassium nitrate, 1% chloral hydrate to be completed with water up to 100%. To be mixed for use with ethylene glycol or glycerine. Not recommended, since the captured specimens deteriorate too soon, potassium nitrate is moderately toxic, irritant for skin and eyes, and chloral hydrate is a sedative and hypnotic drug with a strong potential for health hazard.

Isopropanol. Also known as IPA or isopropyl alcohol, it is a cheap dissolvent with many uses. It is moderately toxic to humans, being a central nervous system depressant. It is also highly flammable, and should be used only in well-ventilated areas.

Picric acid. Also known as TNP, it is 2,4,6-trinitrophenol. Its use should be discarded because of health hazard, being corrosive, explosive, toxic by inhalation, oral consumption or skin contact, damaging lungs, liver and kidneys.

Propylene glycol. Proposed as an alternative to ethylene glycol by some authors because of its lesser toxicity, it presents similar properties, but may be more difficult to obtain. Even so, it is an eye and skin irritant, may harm the respiratory tract, and it is also allergenic and mutagenic.

Turquin's liquid. Original Turquin's (1973) formula modified after Ashmole & Ashmole (1987): 10 g chloral hydrate, 5 ml formalin, 5 ml glacial acetic acid, 1 ml detergent and dark beer added to make one liter. It is hazardous because of the presence of chloral hydrate and formalin (see above), and of glacial acetic acid, which in pure state is a strong corrosive burning skin and mucous membranes, and is flammable in contact with air over 39°C.

Vinegar. It is usually a 4-8% acetic acid solution in water (typically 5%). Natural vinegars contain other acids in addition. A good preservative, the commercial brands from white wine ought to be selected.

Water. It may repel certain species, and as such is not a good preservative liquid. When supersaturated with salt, it can be used for long stay traps. A saturated sodium chloride brine depends upon temperature, hot water admits more salt than cold. Solubility at standard state (25°C, 100 kPa) is 35.9 g / 100

ml, so if this amount of salt is placed in 100 mL of distilled or soft water, it will be probably soon hypersaturated in cold conditions because of the lowering of the temperature or in hot conditions because of the evaporation. Probably the most innocuous preservative agent, both for users and environment. In addition, it is inexpensive.

Chapter 10

Sampling continental freshwaters

by

Antonio G. Valdecasas

Museo Nacional Ciencias Naturales (MNCN), Madrid, Spain
Email: valdeca@mncn.csic.es

Marina Aboal

Murcia University, Murcia, Spain
Email: maboal@um.es

Santos Cirujano

Real Jardín Botánico, Madrid, Spain
Email: santos@rjb.csic.es

Sanda Iepure

Speleological Institute 'Emil Racovitza' Cluj, Romania
Email: siepure@hasdeu.ubbcluj.ro

Damia Jaume

IMEDEA, Mallorca, Spain
Email: vieadjl@uib.es

Heather Proctor

University of Alberta, Canada
Email: hproctor@ualberta.ca

Jose Luis Velasco

MNCN, Madrid, Spain
Email: velasco@mncn.csic.es

Responsibilities per chapter part:

Marina Aboal (Algae); Santos Cirujano (Aquatic vascular plants); Sanda Iepure (Subterranean habitats); Damia Jaume (Anchialine waters); Heather Proctor (Macroinvertebrates and sample processing); Jose Luis Velasco (Microinvertebrates) and Antonio G. Valdecasas (Coordinator and contributor of various topics).

Abstract

This chapter provides a summary of methods used for collecting freshwater organisms, covering algae, aquatic macrophytes, and invertebrates. It does not deal with aquatic fungi or freshwater vertebrates, which are dealt with in other chapters. After a preliminary introduction, subsequent sections deal with major subdivisions of biota based on taxon and/or body size. We also discuss sampling special habitats, with the subterranean environment (*sensu lato*) and anchialine waters covered in particular detail. We do not pretend to be exhaustive in the presentation of well-known techniques frequently included in freshwater techniques texts, but rather we emphasize 'tricks of the trade' employed by the authors that are rarely described in print. Sampling, sorting and fixing methods are suggested for each major group. The references included, some of them websites, will complement the methods described here.

Key words: algae, aquatic vascular plants, invertebrates, subterranean habitats, anchialine waters

1. Introduction

Life in fresh waters is extremely varied from any point of view, be that size, morphology or behaviour. Texts devoted to promoting 'the importance of life in soil or life in water' tend to emphasize extremes, as if extremes provide the most compelling justification for studying anything. Fresh waters do not lack extremes, but they are a poor argument for defending one's cause. For this chapter, the 'cause' is how to sample freshwater habitats for eukaryotic organisms (excluding vertebrates, which are dealt with in different chapters). At first glance this may seem a straightforward proposition, but many questions immediately arise, among the most important of which is: 'sampling for what purpose?' We distinguish between Taxon-specific, Biodiversity and Ecological sampling, but our main emphasis will rest on Taxonomic sampling.

On the other hand, we do not pretend that we have discovered the many techniques and methods that already populate books, review articles and web pages. We describe techniques that we use currently in our taxonomic practice and provide rarely published hints and tricks that give them a personal flavor. But we do not pretend to be exhaustive. Additional information is available in documents that can be found on the internet, review chapters, monographic books, etc.

We particularly emphasize sources of information easily found on the internet for free; including construction of inexpensive sampling devices and ways to use them. We feel this is important given that the areas of greatest interest for taxonomic research are often in developing countries, where it may be difficult to find prefabricated samplers or where they are so costly as to be prohibitive for the local taxonomist (traditionally a not very well funded professional).

However, the improvement of our knowledge of freshwater biota does not only depend on adequate sampling methods but also on advances in molecular techniques and improvement of image-processing hardware and software.

1.1. Ranges in body size and species-richness of taxa in freshwater habitats

Truly knowing the number of species now living on Earth is a Herculean and likely impossible task. Specialist taxonomists who consult the meritorious work of Chapman (2009) realize that some of his counts of species richness are significant underestimations of the number presently known. For instance, Plecoptera total 2,274 in Chapman (2009) but are raised to 3,497 in the stonefly chapter of the Freshwater Animal Diversity Assessment (see Balian *et al.*, 2008 for a summary of the project). However, the total count by Chapman seems to be fairly accurate.

In the following Table 1 we present a list of the main freshwater taxa with an indication of their approximate range in body size and number of species. It would be useful to include some idea of abundance, but this is too variable. Both variables could give an idea of what amount of diversity may be found or lost

depending on the mesh size and sampling method used. Suggestions for sampling particular groups are provided in additional tables below.

Taxon	Size Range	Number of Species
Microalgae		> 50,000
Macroalgae		>19,000
Aquatic vascular plants		2614
Microinvertebrates		> 15,000
Nematoda	0.2-2 mm	>2000
Gastrotricha	100-300 µm	320
Rotifera	100-500 µm	1498
Tardigrada	50-500 µm	62
Cladocera	0.2-18.0 mm	620
Copepoda	0.3-3.2 mm	2814
Ostracoda	0.4-30 mm	1936
Syncarida	0.5-2.0 mm	240
Halacaridae	140-2000 µm	56
Oribatida	0.3-0.8 mm	86
Hydrachnidia	0.3-3.0 mm	> 6000
Macroinvertebrates		>87,000
Porifera	2-3 cm up to 40 m ²	219
Coelenterata	2-25 mm	<20
Turbellaria	5-30 mm	1303
Nemertea	> 30 mm	22
Nematomorpha	1-100 cm	326
Oligochaeta	0.1-4 cm	>1200
Polichaeta		168
Hirudinea	0.5-45 cm	482
Bryozoa		88
Anostraca	7-100 mm	307
Notostraca	10-58 mm	15
Conchostraca	2-16 mm	<200
Branchiura Argulidae	5-25 mm	113
Cumacea		21
Tanaidacea		4
Mysida	10-30 mm	72
Isopoda	5-20 mm	>994
Amphipoda	5-25 mm	1870
Decapoda	15-130 mm	>2662
Collembola		>103
Ephemeroptera	3-28 mm	3046

Plecoptera	6-50 mm	3497
Odonata	10-45 mm	5680
Hemiptera		4810
Hymenoptera		150
Megaloptera	25-90 mm	328
Neuroptera	6-8 mm	118
Trichoptera		12,627
Coleoptera		18,000
Diptera		27,141
Gastropoda	2-70 mm	>3800
Bivalvia	2-250 mm	1026

Table 1. Size range and global number of species of freshwater taxa (From FADA Project [see Balian *et al.*, 2008]; Pennack, 1978; McLaughlin, 1980; Bartsch, 2004; Thorp & Covich 2001 and other sources).

1.2. Categories of sampling strategies: Taxon-specific, Biodiversity Survey and Ecological

Although this may go against common usage, we would like to keep the distinction between *taxonomy* and *biodiversity*. It is not merely rhetorical as it affects contents, procedures and aims.

In taxonomy, which following Darwin could be loosely defined as ‘*the empirical evidence for speciation*’, the objective is to have the full representation of a certain clade or taxon, in its worldwide distribution. It leads to narrow taxon-focused sampling schemes, usually of a qualitative nature, elevated status of rare specimens (even a single specimen may be important if it is the sole representative of a new species) and very selective in sorting and fixing procedures. In biodiversity surveys the objective is to garner an overview of a variety of taxa in a geographical area during a certain time period. It usually has a wide taxon focus, mainly uses semi-quantitative sampling schemes and is compatible with use of a modest number of general fixatives.

Both contrast clearly with sampling for ecological goals, as the latter usually involves testing hypotheses with either observational or experimental designs, and, in consequence, is problem focused, quantitative or at least replicable.

1.3. A ‘pattern’ cycle of Taxonomic sampling

Under a taxonomically oriented project, the sampling cycle can be subdivided into a presampling, sampling, field sample manipulation, transportation, laboratory manipulation and sample maintenance. The emphasis in this chapter is mainly on actual sampling although occasional information is provided on the other steps of the sampling cycle. Below we briefly describe the other parts of the cycle before moving to taxon- and habitat-specific chapters.

Presampling involves defining the objective of the sampling, target organisms and sites, and compiling a list of material needed. A comprehensive list of sampling

material that can be adapted and enhanced for particular objectives may be found on <http://pubs.usgs.gov/of/2002/ofr-02-150/>. In addition some safety measures should be taken (more on this below).

Field manipulation may involve on-the-spot sorting for organisms that should be brought alive to the laboratory (e.g. Tricladida) or are so delicate so that they need *in situ* fixing (e.g. Ephemeroptera). One should decide in advance what the target groups demand so as to have enough time and material to process samples as required. This is also the time to decide whether duplicate samples or subsamples should be fixed in different fixatives, e.g. absolute ethanol for molecular analysis and the right fixative for taxonomic analysis. Additionally, one may need to quickly record morphological information that may disappear or be difficult to obtain in fixed material (e.g., eye pattern in leeches). Digital imaging of live specimens will likely become common in the near future.

Transportation may be done with the sample already fixed or kept at low temperature with a field refrigerator or inside a container with ice.

Finally, laboratory manipulation may involve additional sieving and sorting, subsampling and transferring to the final fixative. Regular revision of fixative and sample conditions on a yearly basis may be desirable. In some special cases, fixed samples can be stored at low temperature to allow for future molecular studies. For samples coming from fragile habitats the process of sample maintenance is of utmost importance given the value of the material.

1.4. General remarks on classifying water bodies

From a practical point of view, the most important criteria to classify inland water bodies is ease of access, in particular, wadeable versus non-wadeable waters. Everything becomes more problematic when waters cannot be easily accessed on foot, especially if one is sampling in remote areas. This pragmatic subdivision of freshwater habitats is not the most common classification. We mention two other categories of classification. One is the IUCN Habitats Authority File (<http://www.iucn.org/themes/ssc/sis/authority.htm>) where freshwater habitats are classified in the context of all other Earth habitats, the other, our favorite, is that of Elton & Miller (1954) in which a wide variety of different aquatic habitats are summarized along two axes: current speed and size (Table 2). Additional axes could be added to increase the number of habitats covered.

That said it is very common that in taxon-specific sampling the researcher goes alone or in small groups to the field, carrying relatively little equipment. Impermeable rubber boots are an essential element for sampling freshwaters. Waders can be more troublesome, especially in deep places with a swift current. However, boots limit the depth were the researcher can get into: mainly shallow streams and ponds. For deeper ponds and lagoons, besides boats (which are frequently not available), there is the individual solution used by fisherman known as 'float tubes'. Basically they are a floating device (round or in u) where the sampler gets into with fins and diving boots (if the water is cold) and may advance moving the fins. The floating device includes different kinds of pockets for

storage. Prices are below 100 €. For deep water sampling, however, a boat is essential.

	Very small	Small	Medium	Big	Very big
Quiet	Treehole	Small pond (< 17 m ²)	Pond (< 0,4 ha)	Small lake (< 40 ha)	Large lake or sea
Slow	Trickle	Ditch	Channel		
Medium	Small stream	Lowland stream	Lowland river	Big river	Estuary
Swift	Spring	Torrent	Swift torrent		
Vertical or Drip		Small waterfall	Medium waterfall	Big waterfall	Very steep waterfall

Table 2. Different aquatic habitats summarized along two axes: current speed and size.

Subaquatic viewers (Fig. 2), which may be as simple as a bucket with the bottom replaced by clear glass, can be extremely useful in shallow or deeper water, specially when the flow is high or the water is not very transparent.



Fig. 1. Observing in wadeable waters. (Photo by Maria Eugenia Cañadas)

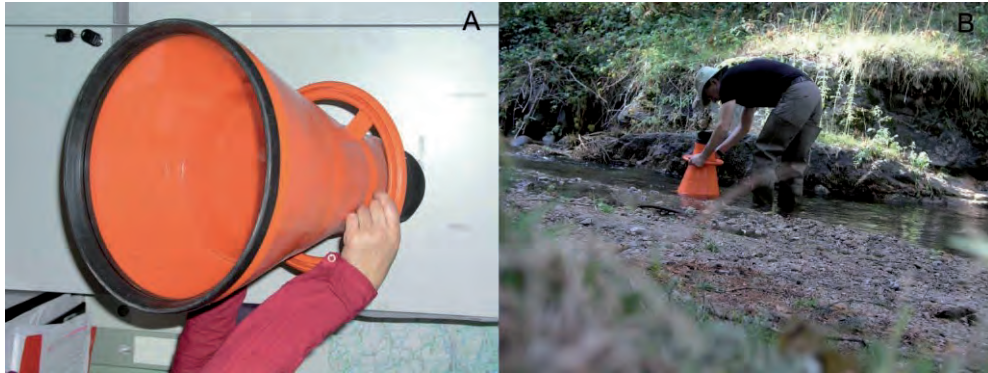

Fig. 2. The view bucket. A. Bottom; B. Correct usage (Photos by Antonio G Valdecasas)

1.5. Safety notes

To our knowledge there has not been an exhaustive study of risks for freshwater field work similar to the report of Nancy Howell (1990). However, many of the risks evaluated in that report are similar to those which natural history researchers confront.

When planning a sampling trip to a remote or poorly known area, information and recommendations such as those included in Johnson *et al.* (2008) "Handbook of Expedition and Wilderness Medicine" can be extremely useful. Information and common sense are key words for a successful sampling trip.

And finally, care should be taken when dealing with fixatives, as many of them are toxic and should be manipulated under safe conditions. The product information labels to proceed as required.

1.6. Additional information and some general web pages

The U.S. Geological Survey has published a set of books under its National Water-Quality Assessment (NAWQA) program that are available at <http://water.usgs.gov/nawqa/>. Some of them are mentioned in the sections below.

Especially useful are the IBP Handbooks (International Biological Program) published by Blackwell in the 1960's and 70's. Relevant for the organisms dealt in this chapter are Vollenweider's (1969, 1974) manual on primary production, where a very detailed review of techniques to sample phytoplankton, periphyton and macrophytes may be found. The IBP handbook n° 17 edited by Edmondson & Winberg (1971) includes chapters on zooplankton, benthos of standing and flowing waters, periphyton interstitial fauna and a review of emergence traps plus a chapter on sorting and counting organisms. Hauer & Lamberti (2007) cover a great diversity of stream-specific methods.

Another series of books that may help when planning or revising the information available on faunistically or floristically still poorly known countries is the set of Limnology in Developing Countries books, published by the International Association of Limnology (SIL). Four volumes have been published up to date.

The best way to get advice on particular items concerning freshwater sampling and organisms is to address the specialists themselves. Many of them may be found through the help of learned society and international organizations devoted to the scientific study of water habitats. We include below three of them:

- The International Society of Limnology (<http://www.limnology.org/index.shtml>)
- The Freshwater Biological Association (<http://www.fba.org.uk/index.html>)
- The North American Benthological Association(<http://www.benthos.org/index.aspx>)

1.7. References

BALIAN, E.V., LÉVÊQUE, C., SEGERS, H. & MARTENS, K. (Eds) 2008. Freshwater Animal Diversity Assessment. *Hydrobiologia* 595: 3-8.

CHAPMAN, A.D. 2009. *Numbers of living species in Australia and the World*. 2nd edition, Australian Biodiversity Information Services, Toowoomba, Australia. 84 pp.

EDMONDSON, W.T. & WINBERG, G.G. 1971. *A manual on methods for the assessment of secondary productivity in fresh waters*. IBP handbook n° 17. Blackwell Scientific Publications, Oxford: 358 pp.

ELTON, C.S. & MILLER, R.S. 1954. The ecological survey of animal communities: with a practical system of classifying habitats by structural characters. *Journal of Ecology* 42: 460-496.

HAUER, F.R. & LAMBERTI, G.A. 2007. *Methods in stream ecology*. 2nd edition. Elsevier: 877 pp.

HOWELL, N. 1990. *Surviving fieldwork*. American Anthropological Association Special Publication n° 26: 217 pp.

JOHNSON, C., ANDERSON, S.R., DALLIMORE, J., WINSER, S. & WARRELL, D.A. 2008. *Oxford Handbook of Expedition and Wilderness Medicine*. Oxford University press, Oxford: 710 pp.

VOLLENWEIDER, R.A. (Ed.) 1969, 1974. *A manual on methods for measuring primary production in aquatic environments*. IBP handbook n° 12. Blackwell Scientific Publications, Oxford: 213 pp (225 pp.).

2. Sampling continental algae

Algae are the dominant autotrophic organisms in many aquatic systems, including fresh and brackish waters. Some of them are the sole photosynthetic organisms in extreme habitats (Ciniglia *et al.*, 2004). Presently four Kingdoms are included in the polyphyletic group called 'algae' (Cavalier-Smith, 2004).

2.1. Safety notes

Where toxic algae are expected, it is recommended to use gloves. Some toxic species can produce aerosols that may affect the respiratory system (Cheng *et al.*, 2007). Also, care should be taken when sampling water bodies inhabited by invasive species to avoid accidentally dispersing them to other water bodies.

Almost all fixatives are toxic if inhaled and it is recommended to carry out all the fixation procedures in well-ventilated areas or under a fume hood in the case of formaldehyde. Ideally the material should be taken alive to the lab in a portable fridge (dark and cold conditions). Fixation should be done then in the lab with gloves and safety glasses. If it is compulsory to fix the material in the field it is advisable to transport all the reactive agents inside air-tight boxes to avoid accidental inhalation. All the materials used for fixation and their remains should be disposed of appropriately.

2.2. Sampling the plankton

To collect the diversity of phytoplankton typically present in standing water bodies, there are different kinds of plankton nets and sampling bottles. Both allow vertical and horizontal sampling, but bottles allow calculations of the density of cells when counted under sediment chambers with a known volume and with inverted microscope (Utermohl method).

It is advisable to carry out a preliminary observation of the material to see the movements of the organisms, their true colors, and some structures that are not detected in fixed material, such as a contractile vacuole (Chlorococcales). The use of Lugol (IJK) allows gentle fixation that keeps the flagellum but is of short duration. Formaldehyde (2-4%) allows a long-term fixation. Alternatively glutaraldehyde (2-3%) may be used as its vapors narcotizes motile species and facilitates their microscopic study (see Table 3).

If the study is focused on a single taxonomic group then the routine can be simplified. If the groups have a tough envelope alternative reagents may be employed (see Table 3).

When doing molecular studies one must have a duplicate in absolute ethyl alcohol or at -20°C .

For ecological studies it is often enough just to know which general categories of algae are present. Flow cytometry allows discrimination of cells by size, shape and pigments. This type of evaluation can be done either in the field with portable equipment or in the laboratory.

2.3. Sampling the benthos

Before beginning sampling it is useful to do a visual inspection of the area under study to establish its heterogeneity and take samples from all the microenvironments available.

Microphytobenthos are algae whose presence can only be detected by the color of the substrate. To sample these communities it is useful to use a brush, scalpel or jackknife on hard substrates, and PVC cylinders or Petri dishes on soft substrates. If the hard substrates cannot be taken out of the water it is necessary to use tubular samplers that can be held securely inside the water (Steinman *et al.*, 2007). Methods of fixation are similar to that used with phytoplankton.

In some cases when substrates are scarce, or if one desires to compare algal assemblages between two locations while holding the substrate type constant, then artificial substrate can be used: microscope slides, stones, plastic materials, bricks, tiles, etc. However, artificial substrates are selective and different substrates will not necessarily be colonized by the same arrays of algae (Cairns, 1982).

Macrophytobenthos are macroalgae that can easily be recognized in the field with the naked eye and can be separated from the substrate with scalpels or razors if they develop on hard substrate, or with hooks or a potera (squid jig) when forming meadows on soft substrate. It is important to get the basal portions of macroalgae, as they may be essential for the taxonomic identification. Specimens can be fixed with formaldehyde or processed as is done for vascular plants (see below). Dry material can be used for molecular studies without further treatment (see also chapter 7).

2.4. Sampling shallow and deep waters

See the introduction.

2.5. Sampling special habitats

2.5.1. Caves and hypogean environment

To preserve these fragile ecosystems, especially when sampling stalactites, stalagmites or close to old remains of primitive human artifacts, sampling methods that are not very aggressive such as adhesive paper or moistened filter paper are to be used (more information in § 6 to 8)

2.5.2. Endophytic algae on aquatic plants

The host plant is collected (*Lemna* sp., *Sphagnum* sp.) and preserved in formaldehyde.

Table 3 summarizes in more detail the algae groups, their habitats and growth forms, number of species and appropriate fixatives.

2.6. References and web pages

CAIRNS, J.JR. 1982. Artificial substrates. Ann Arbor, Michigan: 279 pp.

CAVALIER-SMITH, T. 2004. Only six kingdoms of life. *Proceedings of the Royal Society B*, 271(1545): 1251-1262.

CHARLES, D.F., KNOWLES, C. & DAVIS, R.S. 2002. Protocols for the analysis of algal samples collected as part of the U.S. Geological Survey National Water-Quality Assessment Program. Report n° 02-06: 132 pp (available at <http://water.usgs.gov/nawqa/>).

- CHENG, Y.S., YUE, Z., IRVIN, C. M., KIRKPATRICK, B. & BACKER, L.C. 2007. Characterization of Aerosols Containing Microcystin. *Marine Drugs*, 5(4): 136-150.
- CINIGLIA, C., YOON, H.S., POLLIO, A., PINTO, G. & BHATTACHARYA, D. 2004. Hidden biodiversity of the extremophilic Cyanidiales red algae. *Molecular Ecology* 13: 1827-1838.
- CORLISS, J.O. 2000. Biodiversity, classification and number of species of protists. *In: RAVEN, P. & WILLIAMS, T. (Eds). Nature and Human Society: the quest for a sustainable world.* National Academy Press, Washington D.C.: 130-155.
- GRAHAM, L.E. & WILCOX, L.W. 2000. *Algae*. Prentice Hall. New York.
- GUIRY, M.D. & GUIRY, G.M. 2009. AlgaeBase. World-wide electronic publication, National University of Ireland, Galway. <http://www.algaebase.org>; accessed on 15 December 2009.
- MOULTON, S.R.II, KENNEN, J.G., GOLDSTEIN, R.M. & HAMBROOK, J.A. 2002. Revised Protocols for Sampling Algal, Invertebrate, and Fish Communities as Part of the National Water-Quality Assessment Program. U.S. Geological Survey, Open-File Report 02-150: 87pp. (available at <http://water.usgs.gov/nawqa/>).
- STEINMAN, A.D., LAMBERTI, G.A. & LEAVITT, P.R. 2007. Biomass and pigments of benthic algae. *In: HAUER, F.R. & LAMBERTI, G.A. (Eds). Methods in stream ecology*, Academic Press: 357-379.
- VOLLENWEIDER, R.A. (Ed.) 1969, 1974. *A manual on methods for measuring primary production in aquatic environments*. IBP handbook n° 12. Blackwell Scientific Publications, Oxford: 213 pp. (225 pp.).

Taxon	Gross habitat	Specific habitat	Habit	Number of species	Recommended fixative	Extra treatment	DNA preservation
Microalgae							
Cyanophyceae	Standing/flowing waters	Epipelon, epilithon, epifiton, plancton	Unicellular, colonies, filaments	2664 ⁽¹⁾	Formaline or drying	EDTA or light acid treatment	Absolute methanol, frozen (-20°C), dried
Rhodophyceae	Standing/flowing waters	Epilithon, epifiton	Unicellular, colonies, filaments	5000-6000 ⁽³⁾	Formaline or drying		Absolute methanol, frozen (-20°C)
Prasinophyceae	Standing water	Plancton	Unicellular	300 ⁽²⁾	Lugol or formaline, better if study alive	Narcotizing previous fixing	Absolute methanol, frozen (-20°C)
Chlorophyceae	Standing/flowing waters	Plancton, epilithon, metaphyton	Unicellular, colonies, filaments	3500 ⁽²⁾	Lugol or formaline	EDTA or light acid treatment	Absolute methanol, frozen (-20°C)
Trebouxiophyceae	Standing/flowing waters	Plancton, metaphyton	Unicellular, colonies		Lugol or formaline		Absolute methanol, frozen (-20°C)
Charophyceae	Standing/flowing waters	Epilithon, epipelon	Unicellular, colonies, filaments	11700 ⁽²⁾	Lugol or formaline		Absolute methanol, frozen (-20°C)
Bacillariophyceae	Standing/flowing waters	Epipelon, epilithon, epifiton, plancton	Unicellular, colonies	20000 ⁽²⁾	Formaline	Organic matter oxidation	Absolute methanol, frozen (-20°C)
Chrysophyceae	Standing water	Plancton	Unicellular, colonies	1250 ⁽²⁾	Lugol, formaline, glutaraldehyde		Absolute methanol, frozen (-20°C)
Glaucophyceae	Standing water	Plancton	Unicellular, colonies	15 ⁽²⁾	Lugol, formaline, glutaraldehyde		Absolute methanol, frozen (-20°C)
Synurophyceae	Standing water	Plancton	Unicellular, colonies		Lugol, formaline, glutaraldehyde		Absolute methanol, frozen (-20°C)
Xanthophyceae	Standing water	Plancton	Unicellular, colonies, filaments, siphonous	600 ⁽³⁾	Lugol, formaline, glutaraldehyde		Absolute methanol, frozen (-20°C)
Cryptophyceae	Standing water	Plancton	Unicellular	200 ⁽²⁾	Lugol, formaline, glutaraldehyde, better if study alive		Absolute methanol, frozen (-20°C)
Prymnesiophyceae	Standing water	Plancton	Unicellular	500 ⁽²⁾	Lugol formaline, glutaraldehyde		Absolute methanol, frozen (-20°C)

Dinophyceae	Standing water	Plankton	Unicellular, colonies	2000 ⁽²⁾	Lugol, formaline, glutaraldehyde	Hypochlorite treatment	Absolute methanol, frozen (-20°C)
Euglenophyceae	Standing water	Plankton/benthos	Unicellular, colonies	1600 ⁽²⁾	Lugol, formaline, glutaraldehyde		Absolute methanol, frozen (-20°C)
Raphidophyceae	Standing water	Plankton	Unicellular	36 ⁽²⁾	Lugol, formaline, glutaraldehyde, better if study alive		Absolute methanol, frozen (-20°C)
Eustigmatophyceae	Standing water	Plankton	Unicellulat		Lugol, formaline, glutaraldehyde, better if study alive		Absolute methanol, frozen (-20°C)
Macroalgae							
Rhodophyceae	Flowing water	Epilton	Filaments, laminar	5000-6000 ⁽³⁾	Formaline or drying		Absolute methanol, frozen (-20°C)
Ulvophyceae	Standing/flowing waters	Epipelon, pleuston	Filaments, laminar	300 ⁽²⁾	Formaline or drying		Absolute methanol, frozen (-20°C), dried
Charophyceae	Standing/flowing waters	Rhizobenthos	Filaments	11700 ⁽²⁾	Formaline or drying	EDTA or light acid treatment	Absolute methanol, frozen (-20°C), dried
Phaeophyceae	Flowing water	Epipelon	Filaments, laminar	1600 ⁽²⁾	Formaline or drying		Absolute methanol, frozen (-20°C), dried

⁽¹⁾ Guiry & Guiry, 2009; ⁽²⁾ Corliss, 2000; ⁽³⁾ Graham & Wilcox, 2000

Table 3. Gross and specific habitats, number of species and fixatives for freshwater algae

3. Sampling aquatic plants

3.1. Introduction

This section is dedicated to the sampling of vascular aquatic macrophytes *sensu stricto*, those plants that complete their life cycle when all their parts are submerged or floating in the water (Den Hartog & Segal, 1964). This group of plants is called 'hydrophytes' (hydro = water, phyte = plant).

There are other plants that are usually included in the generic term 'aquatic plants' but they are properly amphibian as only their basal part is submerged when they reach their maximum development. These plants are generally known as 'helophytes' (helo= swamp), and typical genera are *Phragmites*, *Sparganium*, *Typha* and *Eleocharis*. They are collected and preserved as any other terrestrial plant.

Within vascular aquatic plants several biological types based on their morphological characters or the relation with the substratum can be distinguished, including rooted (rhizophytes) or floating in the water and completely submerged (pleustophyte) (Den Hartog & Segal, 1964; Cirujano *et al.*, 2002). There are aquatic vascular plants that are very noticeable with big leaves and flowers that float on the water surface (*Nymphaea*, *Nuphar*) and other inconspicuous, that live completely submerged with fine leaves and minute flowers (*Zannichellia*, *Althenia*, *Callitriche*). Within both extremes we find a varied range of plants.

The smaller aquatic plants are always more delicate and care should be taken when they are picked up and prepared, as they should retain their flowers and fruit that are often necessary for proper identification.

3.2. Preparing for the sampling trip

Before going to the field it is necessary to prepare the material that should include the following: high rubber boots, swimsuit if sampling clean temperate waters; a medium sized hoe (with a 80 cm wooden handle and a 15 x 8 cm flat end) that will help to extract the plants and increase sampling reach; a note book and a pencil tied to it; card labels (Haynes, 1984)

Obviously, not all aquatic ecosystems are the same. In shallow waters (up to 1 m) sampling is easy as we can get to the bottom easily. For deeper waters it is necessary to use a boat and an aquatic viewer or scuba glasses to see the distribution of aquatic vegetation if the transparency of the water allows it. Fine and rigid hooks with weights attached to a rope can help to sample rooted plants in deep waters. A little practice is necessary to operate the hooks.

3.3. Preparing sampled material

Fine and delicate plants should be deposited in a tray with a small amount of water and a card sheet position below it, arranging the specimens so that they

can be clearly seen with flowers and fruits clearly exposed. It is better to have few well-arranged plants than many crowded ones. With practice it will be possible to dispense with the tray and arrange the plants directly on the card submerging the card at the place being sampled. Strong plants can be arranged directly on the cards. If they are very big, like water lily one should select a small leaf that fits onto the card and cut the flower in half or keep only a representative part of it. The card with the plant should be placed between two sheets of newspaper and with some more sheets between the next cards to act as blotting paper.

Each card requires a label with an identification number. The best practice is to use always the same numbering system and to use correlative numbering with the initials of the name and surname of the collector.

In the notebook write this identification number and any relevant observations regarding the sampled site: locality, area names, date, depth of water, if it was clean or contaminated, etc. and if possible measure the dissolved O₂, pH and salinity. It may be interesting to make a sketch of the spatial arrangement of the vegetation.

Once finished, the cards will go to the field press to tighten them a bit. It is not necessary to tighten too strong as aquatic plants are not woody and if we do it, they will stick strongly to the card and it will not be easy to split them without fracturing.

3.4. Arriving home or the lab

Once at working place the newspaper sheet should be changed and the material pressed again. This process is repeated until the specimens dry completely.

If the material is going to be deposited in a public collection it is necessary to fill a complete card with the name of the plant, if known, locality, geographical coordinates if known, date, collector's name and person who has identified the material.

The material that arrives at a public collection usually undergoes another preparation process, transferring the plants to standard sheets, being numbered and registered and finally frozen at -20°C to eliminate insects and other small creatures that live in stored plants (Forman & Bridson, 1989).



Fig. 3. Sampling hooks. (Photo by Santos Cirujano).



Fig. 4. Preparing a herbarium specimen. A. Arranging the specimen on a Bristol card; B. Example of a herbarium specimen. (Photos by Santos Cirujano).

3.5. References and web pages

CIRUJANO, S., MEDINA, L. & CHIRINO, M. 2002. *Plantas acuáticas de las lagunas y Humedales de Castilla-La Mancha*. Junta de Comunidades de Castilla-La Mancha-Real Jardín Botánico. Madrid, España: 340 pp.

CIRUJANO, S., CAMBRA, J. & GUTIÉRREZ, C. 2005. *Metodología para el establecimiento del Estado Ecológico según la Directiva MARCO del Agua. Macrófitos*. Ministerio de Medio Ambiente. Confederación Hidrográfica del Ebro. Zaragoza, España: 43 pp.

DEN HARTOG, C. & SEGAL, S. 1964. A new classification of the water-plants communities. *Acta Botanica Neerlandica* 13: 367-393.

FORMAN, L. & BRIDSON, D. 1989. *The Herbarium Handbook*. Royal Botanic Garden Kew, England: 214 pp.

HAYNES, R.R. 1984. Techniques for collecting aquatic and marsh plants. *Annals of the Missouri Botanical Garden* 71: 229-231.

VOLLENWEIDER, R.A. (Ed.) 1969, 1974. *A manual on methods for measuring primary production in aquatic environments*. IBP handbook n° 12. Blackwell Scientific Publications, Oxford: 213 pp. (225 pp.) (and references therein).

4. Sampling microinvertebrates

4.1. Defining microinvertebrates

It is not easy to define the precise size range ascribed to freshwater microinvertebrates. As a reference, the microplankton made up by adult and juvenile crustaceans, rotifers and protozoa have body lengths between 50 and 1000 μm , and sometimes exceed 1500 μm . To get a representative sample of these organisms, plankton nets with net mesh size between 25 to 50 μm diameter will be enough, although mesh size up to 100 μm or more could be used taking in account that filtering efficiency is typically diminished due to clogging.

The main fractions in freshwater zooplankton are protozoans (not properly invertebrates), Rotifera, Cladocera and Copepoda (Cyclopoida and Calanoida). Other microinvertebrate groups like Nematoda, Gastrotricha, Tardigrada, etc., are represented in different habitats of standing and flowing waters (see Table 4 for a summary of the habitats of the different groups). This can also be found in the heleoplankton (= swamp) of shallow waters and in the littoral area of deep waters, running waters, interstitial, ponds and in moss, lichens and phytotelmata (see section on special habitats).

To take microinvertebrate samples one should consider the kind of habitat: pelagic and littoral zone of deep waters, shallow standing waters, running and subterranean waters, interstitial and aquatic vegetation.

4.2. Sampling methods

The study of plankton is very well treated in many limnological treatises (see also the section on algae). Prior to sampling, the researcher should be prepared to deal with variation in vertical and horizontal distribution of the organisms in response to physicochemical gradients like light, dissolved oxygen, temperature, pH, and salinity.

To capture the microinvertebrate fraction of the plankton, one can sample horizontally by trawling from a boat at reduced speed or from a fixed location vertically to get a complete profile from bottom to surface. In this latter case we will have an integrated sample of the entire water column that will include those organisms that only live at certain depth where environmental circumstances are adverse for all the other species (*e.g.*, deep anoxic waters of the hypolimnion of lakes in temperate climates).

In eutrophic lakes with abundant seston it is advisable to use nets with mesh size of 100 μm or more. If the conventional plankton nets of 25-50 μm mesh size are used these will rapidly be clogged up, making only short trawling distances possible.

If we would like to ascertain which species live at different depths, it is necessary to use sampling bottles to take localized samples at designed depths or to use a water vacuum pump run by electric batteries. In both cases the sample should be filtered through a mesh size similar to that used for plankton nets and the concentrated sample stored in a small volume. Samples taken with bottles or vacuum pumps are useful for quantitative studies as sampling volume is accurately known. In the case of an oligotrophic lake the amount of water filtered to get an adequate sample of zooplankton could be 50 l or more.

In shallow standing waters it is necessary to take samples of the heleoplankton. In this case, the samples can be taken by hand using a triangular net with a smaller mesh size, slightly above 100 μm , as in this habitat it is usual to find an abundant aquatic vegetation that will reduce the net filtering capacity very quickly. The net should have at its posterior end a plastic container of 50 to 250 ml where the filtered organisms remain. If we are looking for epiphytic microinvertebrates associated with plant surfaces small fragments of that vegetation must be taken and placed in a bottle with a wide mouth previously submerged close to the plant.

In shallow water, it is common that depth increases rapidly as we depart from the shore and it is not possible to sample using only rubber boots. An alternative is to employ a small inflatable boat as the sampling gear is usually less and lighter than that used in the case of deep waters. Another possibility is to use float tubes (see 1.4)

Microinvertebrates can also be found among sand grains in running and still waters. To sample this interstitial milieu one can make a hole in the sand and collect the water that flows to it (see also section on subterranean aquatic habitats).

To sample the benthos of deep waters it is recommendable to use dredges or grabs of a certain weight, thrown from a boat. It is possibly the most complicated

sampling technique due to the size and weight of the gear used. In shallow waters it is enough to drag the net over the bottom surface avoiding disturbing excessively the water to avoid the clogging of the net and to make it easier later to look at the samples under the microscope. In deep littoral areas it is useful to use small dredges.

In shallow running waters and in the higher reaches of streams and rivers there will rarely be much zooplankton, and it is enough to use the same sampling methods employed for the shallow littoral water of lagoons and ponds. The middle and lower reaches of large rivers may contain potamoplankton which will require plankton nets and a small boat if the water current is sufficiently slow.



Fig. 5. Sampling in shallow waters. (Photo by Jose Luis Velasco).

4.3. Fixing protocols

Sample-fixation protocols vary depending on the circumstances and objectives of the sampling trip. Duplicate samples that are examined without fixation are especially helpful to identify soft body forms that distort when in contact with a fixative. It is advisable to keep the unfixed samples refrigerated and in some cases to add a narcotic agent to slow the fast movements that make identification of some species difficult. Narcotic derivatives of cocaine have been used since long ago. The most common ones now are bupivacaine, tricaine and procaine. This last one is used as a 0,04 % solution for 16 h, although the duration will depend on the concentration of the narcotic agent and the response of the different species to it. Other methods to slow moving animals with less legal

problems are to add a volume of boiling water equal to the volume of the sample or carbonate water up to 20% of the total water sample. A viscous material like methyl-cellulose that slows down the animals' movements while keeping them alive may help.

The fixative most commonly employed is neutral formaldehyde at 3-5% final solution, although higher concentrations may be advisable when there is abundant organic matter. When using formaldehyde it is very important to avoid contacting it with bare skin or inhaling its toxic vapors. Other fixatives commonly used are ethyl alcohol at 30-50% and Lugol's solution at 4-5%. Table 4 provides a list with recommended fixatives.

Some rotifer species require observation of the structure of the trophi for proper identification, so it will be necessary to eliminate the soft parts that surround them. To do this it will be necessary to get a great amount of individuals with a micropipette and leave them in a 1 ml chamber with a few drops of sodium hypochlorite at 10%. When there are only a few specimens it is recommendable to observe the dissolution process of the organisms to track the location of the trophi as these parts are usually smaller than 45 μm and can easily be lost.

There are several options to prepare samples for microscopic identification. For quantitative works it is necessary to do precise counts of population density and use Utermöhl sedimentation chambers that allow microscopic observation of the concentrated sample in the bottom. This is equivalent to a flat chamber of 1 ml capacity and it helps the illumination system of the inverted microscope. The height of the tube of the chamber determines the amount of sample volume to observe – from 1 to 100 ml – using the larger chambers for samples with fewer specimens and vice versa.

In qualitative work with taxonomic purpose the objective will be to have the best illuminating condition for the sample. It is convenient to do preparations that allow the best optical condition using the classical crystal slide and a normal microscope in the case of samples with big concentrations of organisms. In the case of scarce samples use flat chambers like Sedgewick-Rafter or composed chambers that allow one to sort through bigger sample volumes. In this case it will be useful to use an inverted microscope to get the magnification equivalent to those attained in a normal microscope, excepting the immersion objectives.

Taxon	Major habitat	Subhabitat	Recommended sieve or net mesh-size (for adults or fully developed aquatic stages)	Taxonomic fixative
Microinvertebrates				
Nematoda	Any flowing or standing water	Sand, mud, debris, vegetation	35 µm	85% alcohol or 5% formalin
Gastrotricha (a)	Mainly standing waters	Debris and on aquatic vegetation (periphyton). Interstitial water in sandy beaches.	Use a 250 µm mesh to remove larger particles and organisms, and examine the material that goes through the mesh	2% Osmic acid/Bouin's fixative
Rotifera (a)	Mainly (but not restricted to) standing waters	Plankton, interstitial and periphyton	45 µm	Hot water treatment first to prevent them from contracting and then place in 30-50% EtOH
Tardigrada	Flowing and some standing waters	Moss and aquatic vegetation	45 µm	85% alcohol or 5% formalin
Cladocera	Generally standing but some in flowing waters	Plankton, benthos, macrophytes, interstitial habitats	90-150 µm	95% EtOH or 5% sugared formalin solution for killing and storing in 70% EtOH
Copepoda	Any flowing or standing water	Plankton, benthos, interstitial habitats	60-200 µm Finer mesh for cave copepods	70% alcohol
Ostracoda	Any flowing or standing water	Vegetation, benthos, interstitial habitats	180 µm	4% formalin 2 days and store in 70% alcohol

Syncarida	Generally flowing waters but some in standing waters	Interstitial waters and caves	100 µm	4% formalin 2 days and store in 70% alcohol
Halacaridae	Standing and flowing water	Interstitial waters, mosses and caves	100 µm	70% alcohol
Oribatida	Standing and slow flowing water	Debris and vegetation	250 µm	70% alcohol
Hydrachnidia	Clean flowing or standing water	Standing, flowing and interstitial waters	250 µm	Koenike's fluid
Macroinvertebrates				
Porifera	Clean flowing or standing water	Growing on any stable submerged substrate	Hand picking	Drying/70% alcohol
Coelenterata	Clean flowing or standing water	Attached to substrate	Hand picking	Bouin's fluid
Turbellaria (a)	Any flowing or standing water	Benthos, on and under rocks, among vegetation and subterranean	Bait, hand picking, 100 µm	Hot Bouin's to fix followed by storage in 70% EtOH
Nemertea	Mainly standing waters	Among vegetation	Hand picking	Anesthetized followed by 70% alcohol
Nematomorpha	Standing and flowing water	Necton, benthos and among vegetation	250 µm	70% alcohol
Oligochaeta	Any flowing or standing water	Benthos, among vegetation and subterranean	180 µm	70% alcohol
Polychaeta	Flowing and interstitial waters	Benthos	180 µm	Bouin's fluid
Hirudinea (a; for eye number and arrangement)	Standing and flowing waters	Benthos and among vegetation; on fish	Hand picking and 180 µm	Anesthetized followed by Schaudinn's fluid

Bryozoa	Clean flowing or standing water	Attached to stable submerged substrates	Hand picking	Anesthetized followed by Bouin's fluid
Anostraca	Standing waters	Necton/benthos	250 µm	85% alcohol or 5% formalin
Notostraca	Standing waters	Benthos	250 µm	85% alcohol or 5% formalin
Conchostraca	Standing waters	Benthos	250 µm	85% alcohol or 5% formalin
Branchiura Argulidae	Standing and flowing waters	On fish hosts and free-swimming	Hand-picking and 250 µm	70% EtOHY
Cumacea	Saline/Brackish coastal lagoons	Necton	250 µm	70% alcohol
Tanaidacea	Saline/Brackish coastal lagoons	Necton	250 µm	70% alcohol
Mysida	Flowing and standing waters	Necton	500 µm	4% formalin 2 days and store 70% alcohol
Isopoda	Flowing waters mainly but some in standing water	Benthos and subterranean	180 µm	70% alcohol
Amphipoda	Flowing waters mainly but some in standing water	Benthos and subterranean	180 µm	70% alcohol
Decapoda	Flowing waters mainly but some in standing water	Benthos	Baited traps and 1 mm Y	4% formalin 2 days and store 70% alcohol

Collembola	Standing water	Surface film	250 µm	70% EtOHY with drop of detergent to break surface tension
Ephemeroptera	Any flowing or standing water	Benthos and among vegetation	250 µm	70% alcohol
Plecoptera	Flowing waters mainly	Benthos	250 µm	70% alcohol
Odonata	Standing water mainly but also many in flowing	Benthos and among vegetation	250 µm	70% alcohol
Hemiptera	Any flowing or standing water	Benthos, nekton, among vegetation, on surface	250 µm	70% alcohol
Hymenoptera	Flowing and standing waters	Benthos, among vegetation and parasitoid in aquatic insects	250 µm	70% alcohol
Megaloptera	Flowing waters	Benthos and among vegetation	250 µm	70% alcohol
Neuroptera	Flowing waters	Benthos and among vegetation	250 µm	70% alcohol
Trichoptera	Any flowing or standing water	Benthos and among vegetation	250 µm	70% alcohol
Coleoptera	Any flowing or standing water	Benthos, nekton and among vegetation	250 µm	70% alcohol
Diptera	Any flowing or standing water	Benthos, plankton (for Chaoboridae) and among vegetation	250 µm	70% alcohol
Gastropoda	Any flowing or standing water	Benthos and among vegetation	250 µm or hand picking	Anaesthetize and then 75% EtOH

Bivalvia	Any flowing or standing water	Benthos and among vegetation	350 µm or hand picking	Anaesthetize and then 75% alcohol
----------	-------------------------------	------------------------------	------------------------	-----------------------------------

Table 4. Major invertebrate taxa, their habitats, and recommended mesh sizes and fixatives. (a) = best examined alive (from Balian *et al.*, 2008; Pennack, 1978; McLaughlin, 1980; Bartsch, 2004; Thorp & Covich, 2001; and other sources)

4.4. References

- DOWNING, J.A. & RIGLER, F.A. (Eds) 1984. *A Manual on Methods for the Assessment of Secondary Productivity in Fresh Waters*. Second edition, Blackwell, Oxford: 501 pp.
- GREEN, R.H. 1979. *Sampling Design and Statistical Methods for Environmental Biologists*. Wiley-Interscience, New York: 257 pp.
- JAMES, M.R. 1991. Sampling and preservation methods for the quantitative enumeration of microzooplankton. *New Zealand Journal of Marine and Freshwater Research* 25: 305-310.
- MAY, L. 1985. The use of procaine hydrochloride in the preparation of rotifer samples for counting. *Internationale Vereinigung für theoretische und angewandte Limnologie, Verhandlungen* 22: 2987-2990.
- NOGRADY, T., WALLACE, R.L. & SNELL, T.W. 1993. *Rotifera. Vol. 1: Biology, Ecology and Systematics*. Guides to the Identification of the Microinvertebrates of the Continental Waters of the World. Vol. 4. ISSN 0928-2440. SPB Academic Publishing bv, The Hague: 102 pp.
- SAKUMA, M., HANAZATO, T., NAKAZATO, R., & HAGA, H. 2002. Methods for quantitative sampling of epiphytic microinvertebrates in lake vegetation. *Limnology* 3: 115-119.
- SCHWOERBEL, J. 1975. *Métodos de hidrobiología*. Editorial Blume. Madrid: 262 pp.
- SCHWOERBEL, J. 1994. *Methoden der Hydrobiologie, Süßwasserbiologie*. 4. Auflage. Gustav Fischer. Stuttgart: 368 pp.
- TURNER, P.N. 1988. Rotifera. In: HIGGENS, R.P. & THIEL, H. (Eds) *Introduction to the study of meiofauna*. Smithsonian Institute Press: 312-317.

5. Macroinvertebrate collection and extraction

'Macroinvertebrates' represent neither a taxonomic nor an ecological category, but rather are defined operationally, on the basis of the size of mesh on which organisms are retained (see Table 1). In marine ecology, the cut-off between macrofaunal and meiofaunal invertebrates is 1 mm (Herman & Dahms, 1992), whereas in freshwater the usual cut-off is 500 µm (Carter & Resh, 2001); however, depending on the study, the lower size boundary of 'macroinvertebrate'

can range from 250 μm to 1 mm. A species can technically be both micro- and macro- at various stages in its life cycle. Most macroinvertebrates are associated to a greater or lesser degree with some sort of substrate, such as macrophytes or gravel, and are rarely completely planktonic. They are thus often referred to as the “benthos” in contrast with zooplankton. The vast majority of freshwater macroinvertebrate species are insects. Representatives of other groups of arthropods (crustaceans, arachnids) and of numerous other phyla (Porifera, Bryozoa, Plathelminthes, Cnidaria, Mollusca, Annelida) also frequently fall into the macroinvertebrate size category.

Benthic macroinvertebrates are probably the best-surveyed of the freshwater invertebrate fauna, in part because many countries have biomonitoring programs specifically aimed at assessing the ‘health’ of fresh waters via the diversity and abundance of macroinvertebrates (*e.g.*, RIVPACS in the United Kingdom, STAR-AQEM in the European Union, AusRivAS in Australia, CABIN in Canada, as well as various state-specific protocols of the U.S. Environmental Protection Agency (Carter & Resh, 2001)) (see References for websites). These programs are focused mostly on running waters, but protocols for assessment of lakes and wetlands also exist, and are being developed at a rapid rate (*e.g.*, Boix *et al.*, 2005; Mack, 2006). Rosenberg *et al.* (2001) provide an on-line bibliography of methods and protocols for assessing benthic macroinvertebrate diversity (http://www.emanrese.ca/eman/ecotools/protocols/freshwater/benthics/reference_s.html). Although much effort is expended on such assessment, the ‘biodiversity’ measured is seldom at the species level (Carter & Resh, 2001). For example, the CABIN protocol requires identification only to family level (http://cabin.cciw.ca/Application/Downloads/cabin_protocol.doc). STAR-AQEM procedures differ depending on the country. For instance, samples from Germany are usually identified up to species level whereas samples from Greece are identified only up to family level (Clarke *et al.*, 2006). Instead, emphasis is typically on rapid sampling and processing in order to assess large numbers of sites. Despite the poor taxonomic resolution associated with many biomonitoring programs, because the intent of their collecting methods is to maximize higher-taxon richness as rapidly as possible at a given site, combining the methods of these programs with more careful taxonomy will result in a good overview of biodiversity for most of the typically sampled types of water bodies (streams, lakes, wetlands).

The following sections review these general methods as well as more taxon-specific or time consuming means of collecting and extracting macroinvertebrates. A very comprehensive survey, with illustrations of devices, is provided by Merritt *et al.* (2008).

5.1. Habitat-based sampling

The main considerations when sampling macroinvertebrates are: (i) is the water flowing or standing?; (ii) is the substrate hard or soft?; (iii) can the substrate be reached by a wading human? (iv) is the substrate bare or covered with macrophytes? (v) is an areal estimate of abundance needed or is the intent to maximize diversity?

5.1.1. Shallow running water

Wadeable streams are among the most tractable and most frequently studied habitats for macroinvertebrates. The literature on sampling methods is enormous, and has been summarized by Resh (1979), Peckarsky (1984), and others. For biodiversity estimation, the most common method is kick-sampling, in which a D-shaped net (shaped like a semicircle, flat on the bottom) is held downstream in the wake of the collector, who shuffles through the substrate backwards for a predetermined distance or time. Both riffles (water moving rapidly over stones) and pools should be sampled in order to collect invertebrates with different sensitivities to oxygen levels and rate of flow. If the stream has undercut banks, one can collect by pushing the net underneath the stream bank overhang. For pools, the collector can bring up silt and debris in the D-net and rinse excess silt from the net by dipping the net bag repeatedly into the water before examining sample in a tray. A general rule for maximizing diversity that holds for both running and standing water habitats is to sample substrates that differ in morphology, be it grain size (e.g. cobble vs gravel) or leaf shape or density (e.g. mosses vs reeds). In water bodies with mostly uniform and monotonous substrates such as mud, sand or cement, it is the small areas with diverse structure where most macroinvertebrate diversity will accumulate. Take out pieces of submerged wood and let them dry to encourage insects to emerge from the crevices (Thorp & Covich, 2001). Even human-made objects such as discarded bottles or shopping carts will create diversity in substrate and flow regimes. The STAR-AQEM biomonitoring protocol emphasizes the importance of sampling all microhabitats that have a minimum 5% coverage of the total substrate (Hering *et al.*, 2004).

With regard to areal sampling, perhaps the most common method for streams is the Surber-type sampler in its various incarnations, which share the features of having a defined (usually square) demarcated area, ideally with basal foam to accommodate irregularities in the substrate, with a downstream capture net. Substrate within the demarcated area is disturbed to a particular depth, with cobble being lifted and rubbed, so that dislodged animals are carried by the current into the net. For Surber and kick-sampling, variation among individual human samplers with regard to vigour of moving the substrate can affect number and diversity of animals collected. An electric pump sampler such as that described by Brooks (1994) can increase efficiency of extraction of animals from stream substrate, and possibly also reduce inter-individual variation in sampling effort.

5.1.2. Deep/rapid running water

For streams that are too deep or rapidly-flowing to allow safe wading, placement and subsequent collection of artificial substrates of known area will allow for estimation of richness and densities of macroinvertebrates. Tiles, bricks or wire baskets of stones can be fixed to the stream bottom and left for weeks or months to be colonized. Larval black flies (Simuliidae) can be collected using plastic tape hung in the current (Hamada *et al.*, 1997). These methods can of course also be used in shallow waters. Use of artificial substrate comes with many caveats,

however, including variation in the attractiveness of textures of substrates to invertebrates, and need for conditioning of certain substrates (e.g., bricks) to leach out chemicals and/or allow an algal biofilm to build up. Air-lift samplers can be used to access stony substrates of moderately deep flowing water (see illustration at http://www.uwitec.at/html/river_benthos.html), but often require two or more operators as well as complicated equipment. Grab or drag-type samplers will work better than air-lifts for soft sediments of large rivers (Drake & Elliott, 1983).

5.1.3. Shallow standing water

Many of the collecting methods useful in running water are also applicable to standing water habitats. The wadeable margins of lakes and wetlands are typically sampled qualitatively using a modified form of kick-sampling, in which the 'downstream' flow is created by the movement of the sampler rather than the water. In a macrophyte rich zone one must move the net up and down in a sine wave through the water column as one walks in order to sample the entire range of vertical habitat. In contrast, in macrophyte free zones, almost all macroinvertebrates will be confined to the bottom substrate, which should be gently disturbed by the feet of the sampler or the edge of the net. For rapid evaluation of the benthic invertebrate diversity of a large area, care should be taken not to collect too much organic substrate or macrophytes, as sorting through this material can be very time consuming. If material is to be picked in the field rather than preserved and examined in the lab, collected macrophytes can be put in a bucket with water from the site, and the water poured into white trays for examination. Because some organisms will cling to the macrophytes, the plants can be set aside in dry trays and periodically examined for invertebrates that attempt to escape from the drying macrophytes. This works particularly well for adult beetles (Clifford, 1991). Masses of vegetation and other debris can also be taken back to the lab and left overnight in water-filled containers. In response to declining oxygen levels in the middle of the debris, many otherwise cryptic organisms (especially hydras and flatworms) will move to the sides of the containers or accumulate on the surface film (Clifford, 1991; Slobodkin, 2001). Snails and leeches can also be collected from the sides of the container once the debris has been removed.

Estimating areal-based abundance of invertebrates from macrophyte-rich sites is much more difficult than from uniform and relatively flat substrates such as mud, sand, or gravel. Several hand-operated or automated cutting devices have been created for harvesting known basal areas of rooted macrophytes (Downing, 1984), but estimation of surface area of the plants is an additional problem. Possibly determining surface area of known dry weights of macrophytes will allow this.

5.1.4. Deep lakes

The benthos of deep standing water is usually sampled with a grab-type sampler, dropped from a boat (Downing, 1984). Coring tubes can also be used; when the end of the tube is capped, the vacuum in the tube prevents sediments from falling

out (under ideal circumstances). The speed at which the grab or coring tube hits the substrate can affect what it captures, as in water bodies with light flocculent layers (e.g., gyttja) a fast moving sampler can blow away this animal rich layer without collecting it, whereas in a heavier sandy substrate a slow-moving or lightweight sampler may not penetrate deeply enough. A dredge can also be used for areal sampling if pulled for a known distance, but this is difficult to control. Probably SCUBA-diving is the best way to ensure consistent areal sampling of deep lake benthos, though even in this case divers must take care to avoid kicking up the flocculent layer. SCUBA-diving or snorkeling is also an efficient way to collect large-bodied but sparsely distributed or attached organisms (e.g. mussels, sponges, bryozoans).

SCUBA-diving based methods are treated in more detail in chapter 11. Trapping

Diversity and abundance of certain groups of freshwater insects can be estimated using emergence traps (Davies, 1984). These traps collect aerial adults of most insect orders, perhaps with the exception of adult Hemiptera (which do not necessarily become airborne upon adulthood) and Coleoptera and Megaloptera (most of which pupate on land). One advantage of emergence traps for biodiversity estimation is that sexually mature individuals (or subimagos, in the case of Ephemeroptera) are collected, and this is the stage on which species-level keys are usually based. Emergence traps are probably not ideal for areal estimation of densities, as many aquatic insects move from their region of larval development to a more confined area (e.g. near shore for Odonata) prior to emergence. For those Diptera that emerge vertically (e.g. Chironomidae, Chaoboridae), emergence traps may provide a good estimate of areal productivity. Malaise traps set up over streams will provide a good biodiversity estimate for adult aquatic insects, although it will be difficult to localize the place of origin. Adults of some aquatic insects can also be collected by pheromone traps (e.g. Trichoptera), but these are very taxon-specific and hence would not be useful for broadly aimed surveys.

An ecologically specialized mode of sampling involves activity traps. For running water, these are drift nets, which collect the invertebrates that have voluntarily or catastrophically entered the water column. This is particularly valuable for larval mayflies (Ephemeroptera) (Clifford, 1991). In standing water, floating bottle traps, with or without luminescent lures such as plastic glow-sticks (e.g. Barr, 1979) can be used in shallow or deep waters. Baiting is another type of activity-related collecting methods. The bait itself may be colonized by macroinvertebrates (e.g. a small piece of liver left for a few hours in the water will attract flatworms; Clifford, 1991) or the bait may be inside a trap (e.g. minnow traps for collecting crayfish; Hobbs, 2001). Other methods aimed at collecting large crustaceans such as crayfish include visiting burrows at night with a flashlight and net to collect the animals when they emerge to forage. Palaemonid shrimp can apparently also be collected at night with the aid of a headlight, as they can be targeted by their red eye-shine (Hobbs, 2001).



Fig. 6. Sampling macroinvertebrates. A. Kick-sampling with D-net in Alberta, Canada; B. Sampling a stream in Saskatchewan, Canada; C. Setting up drift net in stream in Alberta, Canada; D. Drift net in stream Alberta, Canada. (Photos by Heather Proctor)

5.2. Processing samples

5.2.1. Preservation

Collected samples may be mass-preserved in the field and later sorted at the laboratory. They may also be picked at the field site and the organisms individually dropped into preservative, or they may be returned alive to the laboratory for extraction. The first method has the advantage of including all organisms in the sample, but on the negative side, much organic and inorganic substrate is likely to also be included. Picking in the field minimizes extraneous materials but is very likely to be biased towards large and active macroinvertebrates (especially if the person doing the picking is inexperienced), and will underestimate the true diversity of the sample. If the full sample is to be preserved, 10% formalin at a 1:3 ratio of formalin: sample is a good initial preservative. Samples should be transferred into 70% EtOH in the lab after

approximately 3 days in the formalin (CABIN protocol, http://cabin.cciw.ca/Main/cabin_about.asp?Lang=en-ca). The initial process kills specimens quickly with a minimum of fluid preservative and fixes tissues without dissolving exoskeletal calcium (e.g. in ostracods). Replacement of formalin with EtOH makes sorting less hazardous. This procedure is good for many taxa but not for all, e.g. not for water mites (Hydrachnidia), which ideally should be killed and preserved in a mixture of ~45% glycerol: 10% glacial acetic acid: 45% water (Koenike's Fluid or GAW). One of the benefits to sorting in the field is that taxon-specific methods of preservation may be used (for an overview of such methods, see Clifford, 1991).

5.2.2. Extraction of invertebrates from samples

Sorting live samples in the laboratory will provide the greatest opportunity for maximizing observed diversity from a sample. It also allows use of behavioural methods of extracting invertebrates from the 'background noise' of sediments or macrophytes. For extraction of oligochaetes from substrate, Brinkhurst & Gelder (2001) suggest spreading clean sand over the sample or putting the sample on a screen set over clean water. The worms will then actively migrate into the sand or water and be more easily picked out against this background. Some seldom used but potentially valuable methods of extracting invertebrates from macrophyte samples involve use of light and/or heat. Organisms may be encouraged to move out of masses of vegetation or other substrates by creating a thermal gradient, with the coolest zone being periodically examined for invertebrates (e.g. Kolasa, 2001). If this is combined with a light gradient, negatively phototactic organisms may be encouraged to move to the dark, cool end of the gradient. Berlese-Tullgren funnels, although usually used for extraction of soil invertebrates (<http://www.eman-rese.ca/eman/ecotools/protocols/terrestrial/arthropods/soil-litt.html>), can be used to extract a wide range of apparently 'rare' invertebrates (e.g. aquatic Lepidoptera) from macrophytes that have been drained of most of their water (Proctor, pers. obs.). Desiccation caused by the light bulb's heat induces the normally clinging animals to move away from the drying vegetation, deeper into the funnel, and thence into the collection vial.

If a sample is mass-preserved, interference by substrate is a major problem. If the invertebrates clearly differ in size from the mean particle size of the substrate, then sieves can be used to separate the two, though damage to delicate body parts (particularly devastating to Ephemeroptera) may occur with over-vigorous sieving. If they differ in density, then elutriation via bubbling air may separate the usually less dense invertebrates from particles of substrate. Hydrocarbon flotation with kerosene differentially floats objects whose outside structure has affinities to the hydrocarbon (e.g. cuticle of arthropods) (Proctor, 2001), but it is not known whether this method is suitable only for relatively small animals (< 5 mm) or whether it will float larger-bodied animals as well. Some biomonitoring programs employ subsampling trays in which the preserved sample is spread out and a certain number of randomly selected squares within a grid are completely sorted. Clarke *et al.* (2006) emphasize how important it is to distribute the sample evenly across the tray to avoid subsampling errors.



Fig. 7. Berlese-Tullgren funnels. (Photo by Heather Proctor).

5.3. References

AQEM PROJECT : The Development and Testing of an Integrated Assessment System for the Ecological Quality of Streams and Rivers throughout Europe using Benthic Macroinvertebrates. <http://www.aqem.de/mains/about.php>. Accessed 23 November 2009.

AUSTRALIAN RIVER ASSESSMENT SYSTEM. Macroinvertebrates Bioassessment. <http://ausrivas.canberra.edu.au/Bioassessment/Macroinvertebrates/>. Accessed 30 March 2009.

BARR, D. 1979. Water mites (Acari, Parasitengona) sampled with chemoluminescent bait in underwater traps. *International Journal of Acarology* 5: 187-194.

BOIX, D., GASCÓN, S., SALA, J., MARTINOY, M., GIFRE, J. & QUINTANA, X.D. 2005. A new index of water quality assessment in Mediterranean wetlands based on crustacean and insect assemblages: the case of Catalunya (NE Iberian peninsula). *Aquatic Conservation: Marine and Freshwater Ecosystems* 6: 635-651.

BRINKHURST, R.O. & GELDER, S.R. 2001. Annelida: Oligochaeta, including Branchiobdellidae. In: THORP, J.H. & COVICH, A.P. (Eds.). *Ecology and classification of North American Freshwater Invertebrates*. 2nd edition. Academic Press, San Diego: 431-463.

BROOKS, S. 1994. An efficient and quantitative aquatic benthos sampler for use in diverse habitats with variable flow regimes. *Hydrobiologia* 281: 123-128.

CANADIAN AQUATIC BIOMONITORING NETWORK (CABIN) http://cabin.cciw.ca/Main/cabin_about.asp?Lang=en-ca. Accessed 2 May 2009.

- CARTER, J.L. & RESH, V.H. 2001. After site selection and before data analysis: sampling, sorting, and laboratory procedures used in stream benthic macroinvertebrate monitoring programs by USA state agencies. *Journal of the North American Benthological Society* 20: 658-682.
- CENTRE FOR ECOLOGY AND HYDROLOGY 2008. RIVPACS (River Invertebrate Prediction and Classification System): An Introduction. <http://www.ceh.ac.uk/products/software/RIVPACS.html>. Accessed 11 February 2010.
- CLARKE, R.T., LORENZ, A., SANDIN, L., SCHMIDT-KLOIBER, A., STRACKBEIN, J., KNEEBONE, N.T. & HAASE, P. 2006. Effects of sampling and sub-sampling variation using the STAR-AQEM sampling protocol on the precision of macroinvertebrate metrics. *Hydrobiologia* 566: 441-459.
- CLIFFORD, H.F. 1991. Aquatic Invertebrates of Alberta. University of Alberta Press, Edmonton. http://sunsite.ualberta.ca/Projects/Aquatic_Invertebrates/index.php. Accessed 10 February 2010.
- DAVIES, I.J. 1984. Sampling aquatic insect emergence. In: DOWNING, J.A. & RIGLER, F.H. (Eds). *A Manual on Methods for the Assessment of Secondary Productivity in Fresh Waters*. 2nd Edition. IBP Hand Book 17. Blackwell Scientific Publications, Oxford: 161-227.
- DOWNING, J.A. 1984. Sampling the benthos of standing waters. In: DOWNING, J.A. & RIGLER, F.H. (Eds). *A Manual on Methods for the Assessment of Secondary Productivity in Fresh Waters*. 2nd Edition. IBP Hand Book 17. Blackwell Scientific Publications, Oxford: 87-130.
- DRAKE, C.M. & ELLIOTT, J.M. 1983. A new quantitative air-lift sampler for collecting macroinvertebrates on stony bottoms in deep rivers. *Freshwater Biology* 13: 545-559.
- HAMADA, N., COSTA, W.L.S. & DARWICH, S.M. 1997. Notes on artificial substrates for black fly (Diptera: Simuliidae) larvae and microsporidian infection in Central Amazonia. Brazil. *Anais da Sociedade Entomologica do Brasil* 26: 589-593.
- HERING, D., MOOG, O., SANDIN, L. & VERDONSCHOT, P.F.M. 2004. Overview and application of the AQEM assessment system. *Hydrobiologia* 516: 1-20.
- HOBBS, H.H. III. 2001. Decapoda. In: THORP, J.H. & COVICH, A.P. (Eds). *Ecology and classification of North American Freshwater Invertebrates*. 2nd edition. Academic Press, San Diego: 955-1001.
- KOLASA, J. 2001. Flatworms: Turbellaria and Nemertea. In: THORP, J.H. & COVICH, A.P. (Eds). *Ecology and classification of North American Freshwater Invertebrates*. 2nd edition. Academic Press, San Diego: 155-180.
- MACK, J.J. 2006. Developing a wetland IBI with statewide application after multiple testing iterations. *Ecological Indicators* 7: 864-881.
- HAUER, FR. & G.A. LAMBERTI. 1996. *Methods in stream ecology*. Academic Press, San Diego: 877 pp.

HERMAN, R.L. & H.U. DAHMS. 1992. Meiofauna communities along a depth transect off Halley Bay (Weddell Sea-Antarctica). *Polar Biology* 12: 313-320.

MERRITT, R.W., CUMMINS, K.W., RESH, V.H. & BATZER, D.P. 2008. Sampling aquatic insects: collection devices, statistical considerations, and rearing procedures. In: MERRITT, R.W., CUMMINGS, K.W. & BERG, M.B. (Eds). *An Introduction to the Aquatic Insects of North America*. 4th Edition. Kendall/Hunt Publishing Co., Dubuque: 15-37.

PECKARSKY, B.L. 1984. Sampling the stream benthos. In: DOWNING, J.A. & RIGLER, F.H. (Eds). *A Manual on Methods for the Assessment of Secondary Productivity in Fresh Waters*. 2nd Edition. IBP Hand Book 17. Blackwell Scientific Publications, Oxford: 131-160.

PROCTOR, H.C. 2001. Extracting aquatic mites from stream substrates: a comparison of three methods. *Experimental and Applied Acarology* 25: 1-11.

ROSENBERG, D.M., DAVIES, I.J., COBB, D.G. & WIENS, A.P. 2001. Protocols for measuring biodiversity: benthic macroinvertebrates in fresh waters: Ecological Monitoring and Assessment Network. Department of Fisheries and Oceans, Freshwater Institute, Manitoba, : 46 pp. (<http://www.eman-rese.ca/eman/ecotools/protocols/freshwater/benthics/>).

RESH, V.H. 1979. Sampling variability and life history features: basic considerations in the design of aquatic insect studies. *Journal of the Fisheries Research Board of Canada* 36: 290-311.

SLOBODKIN, L.B. & BOSSERT, P.E. 2001. Cnidaria. In: THORP, J.H. & COVICH, A.P. (Eds). *Ecology and classification of North American Freshwater Invertebrates*. 2nd edition. Academic Press, San Diego: 135-154.

STAR (Standardisation of River Classifications) <http://www.eu-star.at/frameset.htm>. Accessed 23 November 2009.

STARK, J.D., BOOTHROYD, I.K.G., HARDING, J.S., MAXTED, J.R & SCARSBROOK, M.R. 2001. Protocols for sampling macroinvertebrates in wadeable streams. New Zealand Macroinvertebrate Working Group Report No. 1. Prepared for the Ministry for the Environment. Sustainable Management Fund Project No. 5103: 57 pp.

THORP, J.H. & COVICH, A.P. 2001. *Ecology and classification of North American Freshwater Invertebrates*. 2nd edition. Academic Press, San Diego: 1056 pp.

UWITEC SAMPLING EQUIPMENT. <http://www.uwitec.at/>. Accessed 5 May 2009.

WRIGHT, J.F., SUTCLIFFE, D.W. & FURSE, M.T. 2000. ASSESSING THE BIOLOGICAL QUALITY OF FRESH WATERS: RIVPACS and other techniques. Freshwater Biological Association, Ambleside, U.K.: 373 pp.

6. Subterranean aquatic habitats

Hypogean life exists in a continuum through different types of karstic, porous and fissured aquifers. Subterranean aquatic habitats vary in void size (e.g. tiny pores in sandy aquifer, caves), degree of interconnectedness between voids, and

strength of hydrological connection with the surface environment (e.g. sinkholes, deep aquifers). The subterranean biodiversity is still underestimated, however in several places might surpass the epigean diversity of a certain area (Danielopol, 1989). Organisms range in body size from less than 1 µm up to 10 mm in some crustaceans. There are two significant differences between surface freshwater and groundwater, first related to composition of the fauna and second to the high endemism within groups (Sket, 1999; Gibert & Deharveng, 2002).

Freshwater subterranean fauna range widely in taxonomic diversity but are dominated by crustaceans, while in surface freshwater habitats insects prevail. This makes groundwater more similar with marine waters than to freshwater (Deharveng *et al.*, 2009). Second, endemism is a rule in groundwater of which fauna is reduced in distribution and frequently limited to few aquifers, and only few species are recorded across large areas. Moreover, the subterranean populations are generally smaller in size in comparison with the epigean ones, and subsequently the species and mainly the endemics are more vulnerable to extinction. When sampling subterranean fauna care should be taken not to over-collect or damage these small and isolated populations. Hence, only collect the minimum number of specimens required for taxonomic purposes. We distinguish the following groundwater habitats: the hyporheic (or interstitial); the hypohelminorheic; springs; wells; deep water table aquifers and caves.

6.1. The hyporheic (interstitial) habitat

The hyporheic or interstitial habitat were first time observed and investigated in the surface rivers (Chappuis, 1942, 1946; Leruth, 1938; Orghidan, 1955; Motaş, 1958). The interstitial is a surface - subsurface hydrological exchange zone (*i.e.* an ecotone) of which extent vertical or horizontal is difficult to be defined without detailed hydrodynamic and/or hydrochemical measurements. The hyporheic zone is temporally dynamic and determined by porosity and relative volume of water recharging the groundwater zone from the channel, or the channel from the aquifer.

6.1.1. Methods of sampling the hyporheic habitat

The hyporheic habitat is sampled by the Karaman-Chappuis technique (only within the shore stream sediments), Bou-Rouch pump, standpipe cores and freezing cores. Artificial substrates and baited/un-baited traps (in both shore and riverbed sediments) might be used (detailed in the section of methods for sampling invertebrates of interstitial lotic waters).

Sampling by the Karaman-Chappuis method

This method involves digging a shallow pit in the shore sector bordering to a stream, allowing it to fill with water, and then filtering the accumulated water (ideally 5-10 l). The method was developed by both Karaman (1934) and Chappuis (1942) to sample the fauna in the water beneath gravel banks at the margins of rivers and streams in both surface and underground. The method is rapid, not time consuming and does not require a specific device, except the

plankton net. The method allows collecting of a large array of interstitial organisms while causing little damage to them. When using this method, the distance from the hole to the river and the depth of the hole should be recorded.

Sampling by Bou-Rouch pumping

The method was developed by Bou & Rouch (1967) and involves the pumping of interstitial water into a stand pipe with a peristaltic pump, driven at various depths into the sediments of a stream. At one end the core has rows of holes, allowing the water and sediments to be extracted. By pumping, a disturbance is created that maintains an interstitial flow around the pipe sufficient to dislodge the hyporheic organisms. The optimal sample volume of water pumped has been estimated to be 1-10 (Boulton *et al.*, 2004). For an accurate estimation in numbers of taxa and individuals, the number of replicates could vary between 3-5 times of 5 l (Malard *et al.*, 2003). It is assumed that in the first 5 l, 76-100 % of the taxa found in 10 l is collected, providing the best density estimate for organisms living in close proximity to sediments. Some authors recommend that the first 0.2-0.5 l of water to be discarded, to avoid the risk of contamination with surface water and its biota (Danielopol, 1976; Boulton *et al.*, 1992). A strong pumping rate is recommended to avoid bias in estimating of hyporheic density. Hence, organisms adhering less tightly to the substrate, (i.e. cyclopoids, ostracods, isopods, and amphipods) may be more easily captured; while others have some abilities to resist mild vacuum pressure. Currently, the Bou-Rouch method is extensively used in hyporheic investigations, although some studies indicate that insect larvae and especially later instars of chironomids are underrepresented in samples (Fraser & Williams, 1997). The Bou-Rouch method has a few disadvantages: i) it is not strictly quantitative because faunal density and diversity cannot be expressed per volume of hyporheic sediments, but comparisons between samples of equal volume are still possible with caution; ii) it is limited in collection at different depths and to streams with sandy and fine gravel sediments; and iii) certain invertebrates may be damaged during the pumping.



Fig. 8. Sampling percolation water. (Photo by Ioana Meleg).

Sampling by standpipe cores

An alternative method perhaps most often used to collect both chemical and invertebrate samples with less impact on organisms, consists of pumping hyporheic water from specific depths in the streambed using permanently installed standpipe wells (Taglianti *et al.*, 1969; Palmer & Strayer, 1996). The advantages of the method are related to low habitat disturbances and the option to use the standpipes for long term monitoring. Additional investigations can be performed with the help of a transparent standpipe 5 cm in diameter installed into the sediments. A video-camera equipped with a light can be introduced into the pipe, and hence in situ observations of sediments and its fauna can be performed. Disadvantages of the method are that the organisms colonizing a permanent core differ significantly, in terms of both composition and abundance, from those animals collected from a newly installed well (Hakenkamp & Palmer, 1992). Further, the samples taken sequentially from a well cannot be used as replicates, because a 48 h period between sequential samples from the same well does not allow adequate time for recovery by the fauna in the immediate vicinity of the pipe. Other sources of bias in samples from colonization of permanent wells include the trapping action in the non-perforated segments of the pipes and the possible attraction of predators/scavengers (Bretschko & Klemens, 1986).

Sampling by freeze coring

In this method, the fauna is paralyzed by an electric field and then the core is frozen with liquid nitrogen (Stocker & Williams, 1972; Hynes, 1974; Bretschko, 1985). This is a more quantitative method than those described above; however, it has the disadvantage that removing a series of frozen cores from a stream bed destroys the habitat for an undetermined, but extended, period. Also, there are several logistic constraints related to weight of the equipment and the core removal from a relatively high depth that is relatively difficult.

6.2. The hypothelminorheic habitat

The hypothelminorheic habitat is a submerged interstitial between soil and rocky beds. Meštrov (1962) defined this habitat as: "*Il est constitué par les sols humides des montagnes, riches en matières organiques et traversés par des filets d'eau courante*". It has often been included among subterranean habitats because it harbors a fauna dominated by species with typical morphological traits associated with subterranean life (Fiers & Gheene, 2002; Culver *et al.*, 2006). This habitat is hypothesized to play a significant role in active colonization's by the surface dwelling organisms of the subterranean realm. The hypothelminorheic habitat may be sampled by using a hand held manually peristaltic pump and filtering the water through a plankton net. Additionally, a cut off water bottle with bait could be used.

6.3. Springs

Springs can be viewed as access points to collect the fauna from epikarst, vadose zone and phreatic zone of an aquifer. They are natural resurgences of groundwater that surfaces through rock faults or fractures that may form a marsh (helocrene), pond (limnocrene), or a brook (rheocrene). Springs may be supplied by water from un-consolidated or consolidated sediments (*i.e.* karst). In a helocrene spring, water seeps out off the ground slowly and is usually temporarily confined to small holes or ditches; while in the limnocrene springs, water comes out of the ground and creates a pond at the source, before flowing out slowly. The pond is usually deeper than in helocrene springs, so that water is permanent. Springs are very heterogeneous and may differ significantly in features (*e.g.* substrate, amount of aquatic vegetation, and degree of shading by spring side vegetation), water chemistry (*e.g.* pH and ionic content), and biotic composition (*e.g.* presence or absence of specific competitors, predators and/or parasites). Being a transition area between groundwater and surface water (ecotone), springs host a mixed assemblage of epibenthic organisms, stygobites (species living exclusively in groundwater) and crenobiont taxa (*i.e.* characteristically occurring in springs). Their investigations are useful for monitoring the quality of groundwater, and for comparing the adaptations of surface and subterranean life.

6.3.1. Methods of sampling springs

There are no specific requirements to sample springs and various methods could be combined taking into account their heterogeneity. The most used method is direct sampling with a drift net in rheocrene springs. These simply consist of a net fixed in place and left to capture organisms as they are washed out of the ground. Noll (1939) describes a spring sampler consisting of a double funnel of bronze wire netting, fixed to a glass flask and sealed with a rubber ring. The device is dug into the mouth of the spring's issue point and removed after several hours. The bottom layers and bed sediments of both helo- and limnocrene springs can be sampled with a pond net, Hess sampler, Surber sampler, Bou-Rouch pump, a freeze core, artificial substrates and traps with baits. The Bou-Rouch pump may clog if silt or fine sand is present. Springs large enough to be accessed by divers can be sampled by installing a large net at the exit and the bottom sediments are shaken dislodging fauna that are after that washed out and into the net.

6.4. Wells

Wells are "open points" within the phreatic zone of porous or karst aquifers.

There are three methods of faunal sampling in wells related to their depth: (i) filtering the water to a Cvetkov net (Cvetkov, 1968), (ii) bait traps, and (iii) pumping the water with a surface-mounted pump.

Sampling with the Cvetkov net is well suited for large wells and requires a dynamic movement of the mesh that allows the sediments and associated animals living at the bottom to be captured through the water column.

Baited containers or nets should be left for at least 12 h to attract the organisms within. Baits can be installed also in a stand pipe for few hours and then water is pumped by using different devices (Husmann, 1964; Danielopol & Niederreiter, 1987; Boulton *et al.*, 1992; Hakenkamp *et al.*, 1994).

Water pumping is suitable for wells less than 8 m deep, and a volume of at least 50 l is required (Malard *et al.*, 1997). This method is often considered quantitative, with the number of organisms collected related to the volume of water pumped. For a well deeper than 8 m, pressure pumps are required (see below).



Fig. 9. A modified version of the Cvetkov net, adapted to sample in shallow wells. (Photo by Damia Jaume).

6.5. Deep water table aquifers

Investigation of aquifers with the water table located deeper than 8 m below the surface requires a pressure pump. Access to the deeper phreatic groundwater can be reached by piezometers (of varying diameters from 2.5 – 20 cm) installed at many places into the water table. A tube can be inserted into a piezometer or borehole and connected to a pump. The flow generated by this is then passed through a sieve or net, or into a tank for holding sediments and fauna.

Several pumps have been tested for their ability to extract water and fauna: centrifugal (Danielopol, 1983; Notemboom & Boessenkool, 1992; Rouch *et al.*, 1993), pneumatic and air-lift pumps (Malard *et al.*, 1994). The main difficulty in using the pumps is to remove the organisms with little damage and the lifting of water and suspended particles efficiently. However, all have a limitation: they could not be used to provide samples at a certain depth within an aquifer. When choosing a suitable device for pumping, it should take into account also the possibility of measuring simultaneously biological and chemical parameters. The centrifugal pump seems to be efficiently used for both. Some studies show that the turbine of the centrifugal pump damages large animals like isopods and amphipods, but it extracts micro-invertebrates in good condition. For instance, Notemboom & Boessenkool (1992) successfully extracted the groundwater copepod *Parastenocaris germanica*. The advantages are that it provides macro-invertebrates in good conditions and is also less expensive. Its limitation is related to the depth from where the water is extracted, which should be at least 50% of the total depth of the well (Roscoe Moss Company, 1990; Malard *et al.*,

1994). The pneumatic pump does not have this problem as long as sufficient pressure is provided, but the cost is 15 times higher.

6.6. Caves

Caves can be viewed as access points to an aquifer and often contain a large variety of aquatic habitats. From the entire array of the subterranean realm, caves are the best sampled. Cave aquatic fauna include a variety of organisms, but is dominated by invertebrates actively or accidentally arriving in underground (Gibert *et al.*, 2005). Such invertebrates potentially inhabit a diversity of subsurface waters (Rouch, 1986; Danielopol, 1989) and are not necessarily restricted to caves. Relating to the rocks in which caves are formed, limestones, gypsum and lava caves can be recognized. The most investigated caves are those from karst aquifers formed in limestones and dolomites where the dissolution of calcium and magnesium carbonate creates a three-dimensional network of interconnected openings (i.e. a drainage network). Two aquatic zones can be distinguished within a cave: unsaturated zone (or vadose) and saturated zone (or phreatic). Each zone contains a large array of aquatic habitats that can be sampled by a combination of methods described above.

An unsaturated zone is partially filled with water that flows by gravitation through deep underground. At the top of the vadose zone is a perched aquifer called epikarst (Mangin, 1974, 1975; Klimchouk, 2004). It is an area of higher porosity and permeability that extends a few meters below the karst surface (Malard *et al.*, 2003). The epikarst permeability decreases with depth and temporary or permanent springs may appear at the contact between epikarst and the less fractured rock. Cave biologists have found a considerable number of both terrestrial and aquatic organisms in drips and seeps percolating from the cave ceilings that are washed out of the epikarst and found later on in pools and even streams (Bobič, 1993; Brancelj, 2004; Sket *et al.*, 2004; Brancelj & Culver, 2004; Pipan, 2005; Pipan & Brancelj, 2004; Pipan & Culver, 2005a; Camacho *et al.*, 2006; Moldovan *et al.*, 2007). The percolating water seems to be rich in organisms where numerous specimens of Copepoda, Nematoda, Oligochaeta and Ostracoda, as well as Turbellaria, Rotifera, Archiannelida ['archiannelids' are no longer considered to be a monophyletic taxon, so perhaps 'polychaetes' would be better], Gastropoda, Araneae, Acarina, Bathynellacea, Isopoda, Amphipoda, Diplopoda, Collembola, Coleoptera, and Diptera larvae are found.

Methods of sampling the epikarst

Water from drips and trickles can be sampled by directing the water through a funnel into a plastic container (Fig. 10). To avoid the loss of the animals, the container is perforated and covered with a plankton net (60-100 μm). The containers can be kept in the cave for a period of 1-4 weeks, but a longer time is required for ecological investigations (1-2 years). Collections can be made at a certain interval of time in relation with the purpose of study, but should cover a rainy period. In order to minimize changes due to births and deaths of various organisms, collection intervals of 10 days are advised. For long term monitoring, the collection could be done monthly. The devices must be located in an area

where water infiltration is more frequent (Rouch, 1968). The number of the trickles selected to be sampled, vary in relation to cave development, water infiltration availability, thickness of the ceiling and not at least the purpose of study. A priori investigations are necessary to detect the location of potential trickles that could be inactive for a limited period of time during a year. The distance between the trickle samples could vary from 1 m up to 1 km corresponding to the same cave or to large cave systems.

Epikarst can be accessed also by sampling the drip pools (gours), puddles, small rivulets, and small pools in the top of stalagmites (Pipan, 2005). They may receive water and organisms from the surrounding fractures (Rouch, 1968). Most hypogean crustaceans appear to prefer pools with fine silt at the bottom, although they are occasionally seen in crystal-lined gours. Water bodies supplied by surface water (epiphreatic waters) appear after periods of floods and form pools, puddles and lakes of different sizes. They should be differentiated by the previous pools feed by subsurface water of the vadose zone.



Fig. 10. Sampling percolation water. (Photo by Ioana Meleg).

6.7. Pools, puddles and epiphreatic waters

6.7.1. Methods of sampling pools, puddles and epiphreatic waters

These habitats can be sampled by filtering the water through a mesh net of 60-150 μm . Small hand pumps and even pipettes can be used to collect the water

and then filtered through the net. Because most species live in sediments (if they are present in the pools) they must be shaken before. Some large crustaceans like amphipods, leave small trails at the surface silt of a pool bottom after feeding, which hence could be an indicator of their presence. The large animals easily seen in pools (more common in large ones), can be collected by hand using forceps or pipette. If the pools are dry, clean water could be added and filtered after few hours (Pleșa, 1972). It is assumed that the organisms that live within the small fissures around the pool might be found in the pool water. In large pools a large quantity of water can be filtered, although the sediments accumulated in the net may make sorting the material difficult.

The vadose zone of a cave may also include large lakes, exogenous rivers that sink into a cave from the surface, and endogenous rivers (autogenic streams) originated from the drainage of rainfall infiltrating through the soil and vadose zone. The subterranean rivers could flow on a bed-rock with or without sediments and hence, interstitial habitat could be available along the entire stream or parts of it within a cave. The interstitial sediments of the rivers sinking from the subsurface are inhabited by a large array of organisms drifting from outside (especially at the entrance of the river underground), and hence, if the sampling aim is to get only stygobites, sampling these rivers should be avoided. Endogenous streams are more likely to contain solely hypogean fauna.

6.8. Subterranean lakes

6.8.1. Methods of sampling subterranean lakes

In large lakes a zooplankton net attached to a length of rope can be used. The net will need to be weighted in order to be thrown from the edge of the water body effectively and sink to the bottom where the invertebrates could be found. Small traps with baits can be used (Chappuis, 1950) for a short period of time (about 1 hour), however, they are not recommended since they can attract large predators like amphipods that may devour the fauna that has gathered. However, sampling by baits in cave environment should be used with caution, since the food is scarce, and the bait will then become a long-lasting focus of attraction which could destroy small and localized populations of hypogean fauna.

6.8.2. Methods of sampling the sediments of subterranean rivers and lakes

Methodologies to collect epibenthic macro- and micro-invertebrates in subterranean environments are similar to those for epigean streams.

The phreatic zone of a cave includes voids which are completely filled with water at equal pressure (water table) or higher than atmosphere, and hence the water flows through a hydraulic gradient. Fauna inhabiting this zone is similar to that found in the water bodies of the vadose zone.

a) Sampling by artificial substrates consists of using a plastic or PVC tube of about 25-30 cm long filled with a synthetic rope (Vervier, 1990). The device is covered by a net in order to prevent the loss of the animals when the device is

pulled out from the sediments. The tubes placed into sediments should be colonized by the organisms living between the interstitial spaces. They are best suited for upstream/downstream studies or studies designed to test for changes in communities over time (Coleman & Hynes, 1970; Hynes, 1974; Mathieu *et al.*, 1984, 1991; Tabacchi, 1990). Artificial substrates provide a relative representative sample of the actual community which is living on a certain surface area of a stream. The method offers the advantages of samples collection from locations that cannot be sampled because of substrate or depth and is non-destructive for the site. There are few disadvantages related to this method: (i) the colonization rates differ from site to site; (ii) the species in sampler may be different than stream bottom; (iii) the long exposure times (6-10 weeks) and, not at least (iv) the vulnerability of samplers to vandalism.

b) Sampling by traps. A container with holes at the bottom and covered by a mesh net allowing the water and the organisms to flow through it can be used as trap. The neck of the container forms a narrow funnel, allowing easy access by invertebrates to the trap, but impeding their exit. It is recommended that the traps are buried in the sediments and kept from 2 hours up to 1-2 days. Baits can be used, and it is expected that wandering invertebrates will move upstream and enter the trap following the smell of the bait in the water. For baits, salami and meat is more attractive than cheese or fish. Trapping is a semi-quantitative method useful to capture large carnivorous like amphipods, isopods and decapods. They are more efficient in interstitial sediments with the water flows rather low. The number of species found by trapping is higher than for pumping, which means that a more complete range of the faunal community is present in the trapped samples.

c) Sampling from deep underground by using devices for pumping. Air lift samples could be also used in siphons if the gallery allows the transportation and usage, although the technique is expensive and not usually used in routine sampling. In large conducts and siphons (submerged tunnels) within the phreatic zone, sampling can be performed by scuba diving (Fig. 11). Divers may carry a funnel with a net used to filter the water while moving upstream, or by scraping the walls and then collect the material deposit that potentially could contain animals.



Fig. 11. Cave diver sweeping the water column with a simple, hand-held plankton net.
(Photo by Damia Jaume).

Many of these sampling methods are discussed and illustrated in the PASCALIS project Sampling Manual available at: <http://pascalis.univ-lyon1.fr/index.html>

Concerning fixation of organisms in this particular habitats we refer to the sections on micro- and macroinvertebrates.

6.9. References

BOTOȘĂNEANU, L. 1998. *Studies in crenobiology: the biology of springs and springbrooks*. Leiden, Netherlands, Backhuys: 262 pp.

BOBIĆ, M. 2003: Microfauna of percolating waters in Lazareva Cave (East Serbia, YU). In: . LJUBOJEVIC V. (Ed.) Proceeding of 4th Symposium on Karst Protection, Beograd: 101-104.

BOU C., & ROUCH, R. 1967. Un nouveau champ de recherches sur la faune aquatique souterraine. *Comptes Rendus de l'Académie des Sciences de Paris* 265: 369-370.

BOULTON, A.J., VALETT, H.M. & FISHER, S.G. 1992. Spatial distribution and taxonomic composition of the hyporheos of several Sonoran Desert streams. *Archives für Hydrobiologie* 125: 37-61.

BOULTON, A.J., DOLE-OLIVIER, M.-J. & MARMONIER, P. 2004. Effects of sample volume and taxonomic resolution on assessment of hyporheic assemblage composition sampled using a Bou-Rouch pump. *Archives für Hydrobiologie* 159: 327-355.

- BRANCELJ, A. 2004. Biological sampling methods for epikarst water. *In*: JONES, W.K., CULVER, D.C. & HERMAN, J.S. (Eds). *Epikarst*, Proceedings of the Symposium Held October 1-4, 2003, Karst Waters Institute Special Publication 9: 99-103.
- BRANCELJ A., & CULVER, D.C. 2005. Epikarstic communities. *In*: CULVER, D.C. & WHITE W.B (Eds). *Encyclopedia of Caves*. Academic/Elsevier Press, San Diego: 223-239.
- BRETSCHKO, G. 1985. Quantitative sampling of the fauna of gravel streams. *Verhandlungen der Internationalen Vereinigung fur Theoretische und Angewandte Limnologie* 22: 2049-2052.
- BRETSCHKO, G., & KLEMENS, W.E. 1986. Quantitative methods and aspects in the study of the interstitial fauna of running waters. *Stygologia* 2: 297-316.
- FRASER, B.G. & WILLIAMS, D.D. 1997. Accuracy and precision in sampling hyporheic fauna. *Canadian Journal of Fisheries and Aquatic Sciences* 54: 1135-1141.
- CAMACHO, A.I. 1992. Sampling the subterranean biota cave (aquatic environment). *In*: CAMACHO, A.I. (Ed.). *The natural history of biospeology*. Museo Nacional de Ciencias Naturales, Madrid, Spain: 135-168.
- CAMACHO, A.I., VALDECASAS, A.G., RODRÍGUEZ, J., CUEZVA, S., LARIO, J. & SÁNCHEZ-MORAL, S. 2006. Habitat constraints in epikarstic waters of an Iberian Peninsula cave system. *Annales de Limnologie - International Journal of Limnology* 42: 127-140.
- CHAPPUIS, P.A. 1946. Un nouveau biotope de la faune souterraine aquatique. *Buletinul Societatii de Stiinte din Cluj, Academie Roumaine* 29: 1-8.
- CHAPPUIS, P.A. 1942. Eine neue Methode zur Untersuchung der Grundwasserfauna. *Acta Scientiarum Mathematicarum Naturalium Kolozsvar* 6: 1-7.
- CHAPPUIS, 1950. La récolte de la faune souterraine. *Notes Biospéologiques* 5: 7-35.
- COLEMAN, M.J. & HYNES, H.B.N. 1970. The vertical distribution of the invertebrate faunas in the bed of a stream. *Limnology and Oceanography* 15: 31-40.
- CULVER, D.C., PIPAN, T. & GOTTSTEIN, S. 2006. Hypotelminorheic – a unique freshwater habitat. *Subterranean Biology* 4: 1-8.
- CVETKOV L. 1968. Un filet phréatobiologique. *Bulletin de l'Institut de Zoologie et Musée, Sofia* 27: 215-218.
- DANIELOPOL, D.L. 1976. The distribution of the fauna in the interstitial habitats of riverine sediments of the Danube and the Pisting (Austria). *International Journal of Speleology*, 8: 23-51.
- DANIELOPOL, D.L. & NIEDERREITER, R. 1987. A sampling device for groundwater organisms and oxygen measurement in multi-level monitoring levels. *Stygologia* 3: 252-263.

- DANIELOPOL, D.L. 1989. Groundwater fauna associated with riverine aquifers. *Journal of the North American Benthological Society* 8: 18-35.
- DANIELOPOL, D.L. 1983. *Der Einfluss organischer Verschmutzung auf das Grundwasser-Ökosystem der Donau im Raum Wien und Niederrösterreich – Forschungsbericht*. Bundesministerium Gesundheit Umweltschutz 5: 155.
- DANIELOPOL, D.L., POSPISIL, P. & ROUCH, R. 2000. Biodiversity in groundwater: a large scale view. *Trends in Ecology and Evolution* 15: 223-224.
- DENDY, A. 1895. *The cryptic fauna of Australia*. Australian and New Zealand Association for Advancements in Science, 6th meeting, Brisbane: 99-119.
- FRASER, B.G. & WILLIAMS, D.D. 1997. Accuracy and precision in sampling hyporheic fauna. *Canadian Journal of Fisheries and Aquatic Sciences* 54: 1135-1141.
- GIBERT, J. & DEHARVENG, L. 2002. Subterranean ecosystems: a truncated functional biodiversity. *BioScience* 52: 473-481.
- HAKENKAMP, C.C. & PALMER, M.A. 1992. Problems associated with quantitative sampling of shallow groundwater invertebrates. In: STANFORD J.A. & SIMONS J.J. (Eds.) *Proceedings of the first international conference on groundwater ecology, U.S. environmental protection agency*, American Water Resources Association, Tampa, Florida: 101-110.
- HAKENKAMP, C.H. PALMER, M.A. & JAMES, B.R. 1994. Metazoans from a sandy aquifer: dynamics across a physically and chemically heterogeneous groundwater system. *Hydrobiologia* 287: 195-206.
- HUNT, G. W. & STANLEY, E.H. 2000. An evaluation of alternative procedures using the Bou-Rouch method for sampling hyporheic invertebrates. *Canadian Journal of Fisheries and Aquatic Sciences* 57: 1545-1550.
- HUSMANN, S. 1964. Morphologische, ökologische und verbreitungsgeschichtliche Studien über die Bathynelles (Crustacea, Syncarida) des Niederrhein-Grundwasserstromes bei Frefeld. *Gewässer und Abwässer* 37/38: 46-76.
- HYNES, H.B.N. 1974. Further studies on the distribution of stream animals within the substratum. *Limnology and Oceanography* 19: 92-99.
- KARAMAN, S. 1934. Die Bathgynellidem von Skoplje. *Mitteilungen über Höhlen und Karstforschung*: 26-30.
- KARAYTUG, S. & BOXSHALL, G.A. 1998. Revision of Paracyclops Claus, 1893 (Copepoda, Cyclopoida, Cyclopidae) with descriptions of four new species. *Bulletin of the British Museum (Natural History), Zoology* 64: 111-205.
- KLIMCHOUK, A. 2004. Towards defining, delimiting and classifying epikarst: Its origin, processes and variants of geomorphic evolution, Speleogenesis and Evolution of Karst Aquifers 2 (1), 13 pages, re-published (modified) from: JONES, W.K., CULVER, D.C. & HERMAN, J. (Eds). *Epikarst*. Proc. of the symposium held October 1-4, 2003 Sheperdstown, West Virginia, USA. Karst Water Institute special publication 9: 23-35.

- LERUTH, R. 1938. La faune de la nappe phréatique du gravier de la Meuse à Hermalle-sous-Argenteau. *Bulletin du Musée Royal d'Histoire Naturelle de Belgique* 14: 1-37.
- MALARD, F., DOLE-OLIVER, M.J., MATHIEU, J. & STOCK, J.H. 2003. Sampling manual for the assessment of regional groundwater biodiversity. PASCALIS European Project: Protocols for the assessment and conservation of aquatic life in the subsurface. UMR CNRS 5023. Ecologie des Hydrosystèmes Fluviaux. Université Claude Bernard, Lyon, France : 74 pp.
- MALARD, F., GIBERT, J., LAURENT, R. & REYGROBELLET, J.-L. 1994. A new method for sampling the fauna of deep karstic aquifers. *Comptes Rendus de l'Académie des Sciences Paris* 317: 955-966.
- MALARD, F., REYGROBELLET, J.-L., LAURENT, R. & MATHIEU, J. 1997. Developments in sampling the fauna of deep water-table aquifers. *Archives für Hydrobiologie* 138: 401-432.
- MANGIN, A. 1974/1975. Contribution à l'étude hydrodynamique des aquifers karstiques. *Annales de Spéléologie* 29: 283-332; 495-601; 30: 21-124.
- MATHIEU, J., MARTIN, D. & HUISSOUD, P. 1984. Influence des conditions hydrologiques sur l'évolution de la structure spatiale et la démographie de l'Amphipode *Niphargus rhenorhodanensis*. Premiers résultats. *Mémoires de Biospéléologie* 11: 27-36.
- MATHIEU, J., MARMONIER, P., LAURENT, R., & MARTIN, D. 1991. Récolte du matériel biologique aquatique souterrain et stratégie d'échantillonnage. *Hydrogéologie* 3: 187-200.
- MENZEL, R. 1926. Cyclopoïdes muscicoles et bromélicoles de Java (Indes Néerlandaises). *Annales de Biologie Lacustre* 14: 209-216.
- MESTROV, M. 1962. Un nouveau milieu aquatique souterrain: le biotope hypotelminorhéique. *Comptes Rendus de l'Académie des Sciences Paris* 254: 2677-2679.
- MOLDOVAN, O. T., PIPAN, T., IEPURE, S., MIHEVC, A., & MULEC, J. 2007. Biodiversity and Ecology of Fauna in Percolating Water in Selected Slovenian and Romanian Caves. *Acta Carsologica* 36/3, Postojna: 493-501.
- MOTAŞ, C. 1958. Freatobiologia, o nova ramura a Limnologiei. *Natura* 10: 21-28.
- NIEDERREITER R. 2002. Sampling equipment. <http://www.uwitec.at>
- NOLL, W. 1939. Die Grundwasserfauna des Maingebietes. *Mitteilungen über Höhlen und Karstforschung*: 3-13.
- NOTEMBOOM, J., & BOESSENKOOL, J.J. 1992. Acute toxicity testing with the groundwater copepod *Parastenocaris germanica* (Crustacea). *Proceeding first international Conference on Groundwater Ecology, American Water Resources Association*, Tampa, Florida: 301-309.

- NOTENBOOM, J., HENDRIX, W. & FOLKERTS, A.-J. 1996. Meiofauna assemblages discharged by springs from a phreatic aquifer system in The Netherlands. *Netherlands Journal of Aquatic Ecology* 30: 1-13.
- ORGHIDAN, T. 1955. Un nouveau domaine de vie souterraine aquatique: le biotope hyporhéique. *Buletinul Biol. Acad. R.P. Romania* 7: 657-676.
- PALMER, M.A. & STRAYER, D.S. 1996. Chapter 15. Meiofauna. *In*: HAUER, F.R. & LAMBERTI, G.A. (Eds). *Methods in stream ecology*. Academic Press, New York: 315-337.
- PIPAN T. 2005. Epikarst- A promising habitat. Copepod fauna, its diversity and ecology: a case study from Slovenia (Europe). *Carsologica* 5: 1-101.
- PIPAN T. & BRANCELJ, A. 2004. Distribution patterns of copepods (Crustacea: Copepoda) in percolation waters of the Postojnska Jama Cave (Slovenia). *Zoological Studies* 43: 206-210.
- PIPAN, T. & CULVER, D.C. 2005. Estimating biodiversity in the epikarstic zone of a West Virginia cave. *Journal of Cave and Karst Studies* 67: 103-109.
- PLESA, C. 1972. Une technique nouvelle pour la récolte de la faune des gours. *Spelunca Mémoires*, IV sér. 1: 119-122.
- POR, F.D. & HADEL, V.F. 1986. Two species of *Attheyella* (Copepoda: Harpacticoidea: Canthocamptidae) from bromeliads of Serra da Jureia (São Paulo, Brazil). *Journal of Crustacean Biology* 6: 777-788.
- REID, J.W. 2001. A human challenge: discovering and understanding continental copepod habitats. *Hydrobiologia* 453/454: 201-226.
- REID, J. W. & SPOONER, J.D. 1998. *Stolonicyclops heggiensis*, new genus, new species, from Georgia, U.S.A. (Copepoda: Cyclopoida: Cyclopidae). *Journal of Crustacean Biology* 18: 405-411.
- ROHNERT, U. 1951. Wassererfüllte Baumhöhlen und ihre Besiedlung. *Archives für Hydrobiologie* 44: 472-516.
- ROSCOE MOSS COMPANY 1990. *Handbook of ground water development*. John Wiley and Sons Ed., New York : 493 pp.
- ROUCH, R. 1968. Contribution à la connaissance des Harpacticides hypogés (Crustacés - Copépodes). *Annales de Spéléologie* 23: 5-165.
- ROUCH, R. 1986. Sur l'écologie des eaux souterraines dans le karst. *Stygologia* 2: 352-398.
- ROUCH, R., PITZALIS, A. & DESCOUENS, A. 1993. Effets d'un pompage à gros débit sur le peuplement des Crustacés d'un aquifère karstique. *Annales de Limnologie - International Journal of Limnology* 29: 15-29.
- SKET, B. 1999. The nature of biodiversity in hypogean waters and how it is endangered. *Biodiversity and Conservation* 8: 1319-1338.
- SKET, B., PARAGAMIAN, K. & TRONTELJ, P. 2004. A census of the obligate subterranean fauna of the Balkan Peninsula. *In*: GRIFFITHS, H. I., KRYSˇTUFEK, B.

& REED, J. M. (Eds.). *Balkan biodiversity. Pattern and process in the European hotspot*. Kluwer: 309-322.

STOCKER, Z.S.T. & WILLIAMS, D.D. 1972. A freezing core method for describing the vertical distribution of sediments in a streambed. *Limnology and Oceanography* 17: 136-138.

TABACCHI, E. 2006. A sampler for interstitial fauna in alluvial rivers. *Regulated Rivers: Research and Management* 5: 177-182.

VERVIER, P.H. 1990. A study of aquatic community dynamics in a karstic system by the use of artificial substrates. *Archives für Hydrobiologie* 119: 15-33.

VIGNA-TAGLIANTI, A., COTTARELI, V. & ARGANO, R. 1969. Messa a punta di metodiche per la raccolta della fauna interstiziale e freatica. *Archivio Botanico e Biogeografico Italiano* 45: 375-380.

TORALES, G.J., HACK, W.H. & TURN, B. 1972. Criaderos de culícidos en bromeliáceas del NW de Corrientes. *Acta Zoologica Lilloana* 29: 293-308.

UNYIAL, P.L. 2000. Some aspects of bryophyte-animal associations. In: MUKERJI, K.J., CHAMOLA, B.P. & SHARMA, A.K. (Eds). *Glimpses in Botany*. A.P.H. Publishing Corporation, New Delhi: 121-128.

7. Sampling anchialine habitats

The term anchialine (Greek anchialos = near the sea) is used to designate salinity-stratified coastal aquifers affected by marine tides but with no surface connection with the sea (Holthuis, 1973; Stock *et al.*, 1986). Anchialine environments include pools excavated in calcareous or volcanic debris or hard substratum, coastal tectonic faults extended below sea level, drowned limestone caves and lava tubes, and the network of flooded narrow fissures and cracks developed in coastal aquifers and accessible only via bore-holes or hand-dug wells. Most of the inhabitants of these environments are of direct marine derivation and display troglomorphic traits, such as regressed eyes and body pigmentation, and elongation of appendages. Crustaceans are the predominant faunistic group, including a representation of primitive, high rank taxa not found anywhere else aside these habitats (*i.e.* Remipedia, Thermosbaenacea, Mictacea, Platycopioida), or of genera displaying extremely disjunct distribution patterns (Iliffe, 2000).

Whereas several of the most remarkable dwellers of anchialine environments live beneath the halocline in locations only reachable by SCUBA diving, others can be easily captured from the surface using very basic equipment. Here we describe some techniques and devices to sample in a broad array of anchialine habitats.

7.1. Completely submerged chambers and passages in drowned caves

Sampling in these habitats requires advanced cave-diving skills. Usually, modified hand-held plankton nets are used to sweep the water column in search of swimming animals (copepods, thermosbaenaceans) that concentrate around

haloclines, or near the floor, walls and ceiling of the cave passages. A useful tool is a plankton net 30 cm in diameter and 1 m long provided with a short, curved handle to be easily operated and transported by a diver (Fig. 11), and that can be easily closed by constriction with one hand or with the add of an elastic strap once the capture has been produced. The net can be used repeatedly during the same dive.

Ordinary small glass vials or jars are used to pick up individual specimens from the water column. Even tiny animals, such as cyclopinid copepods, are revealed as bright spots by the beam of diving torches, and can be captured by hand with a vial. This technique is especially adequate when dealing with fragile animals that loose limbs with ease, such as therosbaenaceans.

More sophisticated devices, enabling sampling in cracks and fissures, include a vast array of aspirators and suction bottles, the so-called "Sket bottle" represents the high of technology as well as of simplicity on that respect (Chevaldonné *et al.*, 2008).

7.2. Cave lakes and anchialine pools

Sampling can be done directly with a small hand-held plankton net (21 cm in diameter, 35 cm long) screwed to a telescoped, extensible (up to 3 m) handle (Fig. 12). The folded handle and unscrewed net can be carried out with ease along the narrow cave passages, and assembled to reach the deeper parts of the pools and cracks from the shore. Several groups of animals that are never attracted by bait, such as metacrangonyctid amphipods, or that live mainly on rotting, submerged wood (atlantasellid isopods, many bogidiellid amphipods) are caught with nets of this sort.

An indirect way of sampling involves the settlement of baited traps on the bottom of the lakes and pools, which are left for a few hours or several days depending on the target group. Cirolanid isopods seem to be attracted by bait during the first few hours only and then disappear; in contrast, some amphipods (such as niphargids, pseudoniphargids and salentinellids) concentrate and persist in the traps by days. The animals are attracted irrespective of the type of bait (whether fish, meat or cheese); nevertheless, due to its compactness, using a piece of sausage has demonstrated to be unbeatable on that respect and is here highly recommended. A simple trap can be constructed using a broad mouth, stout plastic flask with the bottom cut and removed, and with the central portion of the screwing cap cut and adapted to retain a piece of Nyal mesh (Fig. 13). The trap is ballasted with several pieces of lead and is hung by means of a string. A hook of thick metal wire is used to retain the bait in place. The trap lacks of any device to avoid the animals to escape. In order to impede eels, crayfishes or brachyuran crabs to get in and damage the trap or predate on the eventual animals concentrated inside, two pieces of stout plastic grid united with elastic string can be used to block the entrance and to protect the piece of Nyal mesh.

A very simple trap (Fig. 14) consisting of a plastic bottle with the central portion of the stopper drilled to set a narrow pipe has demonstrated to work very well for cirolanid isopods (they concentrate in the bottle and cannot escape), or to sample

on muddy or salty bottoms (where the other type of traps easily collapse with sediment).



Fig. 12. Small plankton net screwed to an extensible handle. The folded handle and unscrewed net can be carried out with ease along the narrow cave passages, and assembled to reach even the deeper parts of the pools and cracks from the shore (Photo by Damia Jaume).

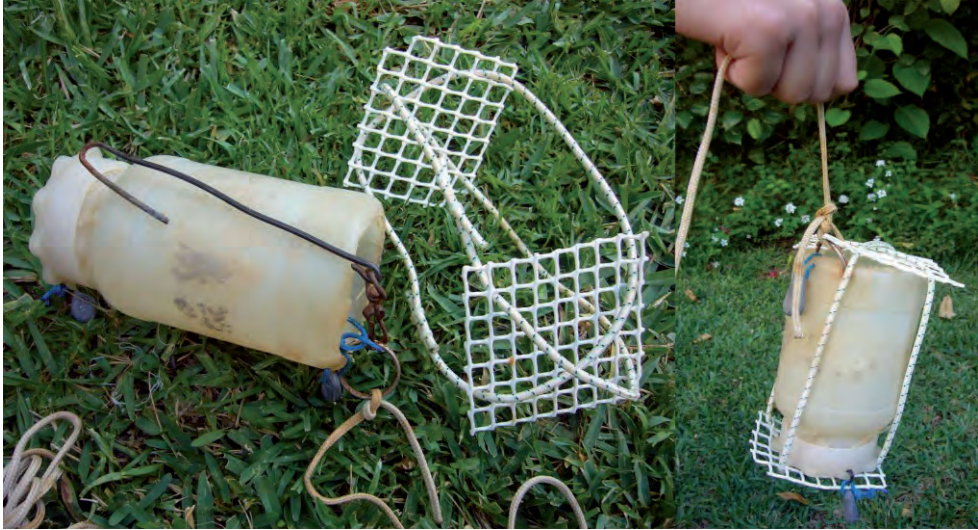

Fig. 13. A simple trap to sample stygofauna in cave lakes and pools. The plastic grid frames can be added to protect the animals eventually attracted by bait from crabs, eels or other potential predators. (Photo by Damia Jaume).



Fig. 14. A simple trap for cirolanid isopods, designed by French biospeleologist Dr. Claude Boutin. (Photo by Damia Jaume).

Sampling inaccessible aquifers: wells and pumps

Shallow brackish-water wells are commonplace in coastal, upraised coral reef terraces and volcanic outcrops, and frequently represent the only pathway to sample aquifers otherwise inaccessible. In addition, these wells (due to accumulation of bird and bat droppings, vegetation remains, animal carcasses, etc.) support high populations of stygobitic crustaceans. Sampling can be undertaken by means of a modified, broader-than-long version of the so-called Cvetkov net (see Cvetkov, 1968), 30 cm in diameter and with the portion corresponding to the funnel reduced to a length of ca. 23 cm; this has proved to work particularly well in these habitats, where the depth of the water column is usually less than 1 m (Fig. 9). Wells provided with pumps and where nets cannot be deployed can be sampled by directly filtering the extruded water, although the specimens eventually caught are frequently damaged (Fig. 15). Finally, it is recommended to ask the landowner for permission if baited traps are to be set in wells that provide water for people or livestock.



Fig. 15. Filtering water directly from a fixed pump at a coastal well. (Photo by Damia Jaume).

7.3. Additional information and web references

Iliffe's web page on anchialine waters warrants a visit (<http://www.tamug.edu/cavebiology/index2.html>)

7.4. References

- CHEVALDONNE, P., SKETT, B., MARSCHAL, C., LEJEUSNE, C., & CALADO, R. 2008. Improvements to the "Skett bottle": A simple manual device for sampling small crustaceans from marine caves and other cryptic habitats. *Journal of Crustacean Biology* 28: 185-188.
- CVETKOV, L. 1968. Un filet phréatobiologique. *Bulletin de l'Institut de Zoologie et Musée, Sofia* 27: 215-218.
- HOLTHUIS, L.B. 1973. Caridean shrimp found in land locked saltwater pools at four Indo-West Pacific localities (Sinai Peninsula, Funafuti Atoll, Maui and Hawaii Islands), with the description of one new genus and four new species. *Zoologische Verhandelingen* 128: 1-48.
- ILIFFE, T.M. 2000. Anchialine cave Biology. In: WILKENS, H., CULVER, D.C., & HUMPHREYS W.F. (Eds). *Ecosystems of the World 30. Subterranean Ecosystems*. Elsevier, Amsterdam: 59-76.
- STOCK, J.H., ILIFFE, T.M., & WILLIAMS D. 1986. The concept "anchialine" reconsidered. *Stygologia* 2: 90-92.

8. Sampling in other special habitats

8.1. Phytotelmata

Phytotelmata (Greek phyton + telm = plant + pond) are small bodies of water held by plant leaves, inflorescences (especially bromeliads) or in tree holes (Fig. 16). They are considered temporary water bodies, even if the habitats themselves are permanently available. Due to their bounded nature and relatively low species richness, phytotelms have been used as models for various ecological processes including dispersal, colonization, species interactions and founder effect.



Fig. 16. Bromeliad *Neoregelia cf. princes*. (Photo by Sanda Iepure).

The organisms found in phytotelms include temporary and permanent inhabitants. However, few studies have been devoted to estimate total species richness and species composition (Frank & Fish, 2008). By far the most complex communities developed in phytotelms are in the wet tropics (Menzel, 1926; Tressler, 1941, 1956; Nodt, 1956; Torales *et al.*, 1972; Reid, 1993). They include algae and representatives of many taxa of freshwater invertebrates: ostracods *Metacypris maracaoensis* Tressler, 1941 found in epiphytic bromeliads in Puerto Rico and Collier County, Florida (Tressler, 1956); harpacticoid crustaceans *Attheyella* and *Elaphoidella* in neotropical bromeliads; or diptera the mosquito *Wyeomyia mitchellii* (Theobald), 1905 originally described from Jamaica, and known also from other islands of the Greater Antilles, eastern Mexico, and Florida. Almost any plant is a potential host for invertebrates in the small amount of water accumulated by the receptacle, but some groups appear to favor phytotelmata and may be considered specialists, *i.e.* the cyclopids crustaceans *Tropocyclops jamaicensis* Reid and Janetzky, 1996 present in bromeliads from Jamaica (Reid & Janetzky, 1996; Reid, 2001) and *Paracyclops bromeliicola* Karaytug & Boxshall, 1998 originally described from bromeliads in Brazil by Karaytug & Boxshall (1998). In temperate areas tree holes developed at the junction between the trunk and limbs are probably the best habit for small invertebrates. They are less studied in comparison with other phytotelms, and hence a low number of species are known from this habitat.

To sample phytotelms water is extracted by using a pipette and then filtered through a mesh net. A manufactured tool could be successfully used especially to collect insect's larvae. It consists of a 50 cm long endoscopic tube with a diameter of 5 mm and an opening of approximately 4 mm attached to the long snout of a 50 ml syringe. The diameter of the tube should be not less than 5 mm, otherwise it could be blocked by debris present in the leaf axils, such as seeds,

leaves and dirt. Conversely, wider tubes can push apart bromeliad leaf axils, not only damaging them but causing increased leakage of water and animals.

8.2. Mosses and leaf litter

Aquatic (*Sphagnum*, *Hypnum*) and terrestrial mosses in humid conditions host a wide variety of invertebrates (Uniyal, 2000). Although water in *Sphagnum* tends to be quite acidic, this type of moss seems to harbor the richest fauna (Gerson, 1982). The hyaline dead cells in leaves retain rotifer, nematodes, various algae or cyanobacteria and numerous taxa of insects. Scourfield (1953) found many species of copepods (*Bryocyclops*, *Muscocyclops*) living in mosses or seeps in rock outcrop where moss and algae are present. Common species are to be found (*Bryocyclops pygmaeus* Sars, 1863) or rare species like *Stolonicyclops heggiensis* (Reid & Spooner, 1998).

Normally aquatic taxa of invertebrates have been reported from sodden leaf litter from scattered areas around the world, including New Zealand beach forest litter, (Harding, 1958), Australian forests (Dendy, 1895; Plowman, 1979), a sedge meadow in the Canadian tundra (Bliss *et al.*, 1973), the Paramo region in the Colombian Andes (Sturm, 1978), and a wet campo marsh in sub-tropical Brazil (Reid, 1984). In Europe, where extensive forests of *Fagus silvatica* exist, leaves form a dense layer that retains water and animals live mainly in the deeper more humid layers (Nielsen, 1966; Schaeffer, 1991; Dumont & Maas, 1998). Fiers and Gheene (2000) surveyed soil nematodes in Belgium, and found a large number of copepods in the litter sample in spite of using an inadequate method for collecting this normally aquatic group. Some of the species found display particular traits of a subterranean inhabitant like *Graeteriella unisetigera* (Graeter, 1908), and hence, the authors suggested that leaf litter was important in the dispersal and population maintenance of stygofauna.

Mosses and leaf litter may be sampled by washing the substrate through a mesh. For the leaf litter a corer for soil samples with a diameter of 2-5 cm could be used, and remove 2-5 kg of soil. The depth of the sample depends on the vegetation type and could range from the surface to a depth of 40 cm. In the laboratory a small amount of soil (representing about 5% of the entire sample) is suspended in distilled water. The mixture is sieved with a mesh net and the fractions smaller than 2 mm are suspended in distilled water. This solution could be sieved again through a smaller mesh than the previous one, and the retained residue is fixed in 4% formaldehyde. The residue is afterwards centrifuged once in distilled water, once in a 50% solution of Ludox® and water. The organisms are further sorted under the stereo-microscope. See also the section on macroinvertebrate extraction from macrophytes using Berlese-Tullgren funnels. This method will extract many of the arthropods from wet moss and litter, but is not appropriate for most soft-bodied invertebrates.

8.3. References

- BLISS, L.C., COURTIN, G.M., PATTIE, D.L., RIEWE, R.R., WHITFIELD, D.W.A. & WIDDEN, P. 1973. Arctic tundra ecosystems. *Annual Review of Ecology, Evolution and Systematics* 4: 359-399.
- DENDY, A. 1895. *The cryptic fauna of Australia*. Australian and New Zealand Association for Advancements in Science, 6th meeting (Brisbane): 99-119.
- DUMONT, H.J. & MAAS, S. 1988. Five new species of leaf litter harpacticoids Crustacea, Copepoda from Nepal. *Zoologica Scripta* 17: 55-68.
- FIERS, F. & GHEENE, V. 2000. Cryptozoic copepods from Belgium: diversity and biogeographic implications. *Belgian Journal of Zoology* 130: 11-19.
- FRANK, J.H. & FISH, D. 2008. Potential biodiversity loss in Florida bromeliad phytotelmata due to *Metamasius callizona* (Coleoptera, Dryophoridae), an invasive species. *Florida Entomologist* 91: 1-8.
- GERSON, 1982. Bryophytes and invertebrates. In: SMITH, A.J.E. (Ed.). *Bryophyte Ecology*. Chapman and Hall, New York: 291-332
- HARDING, J.P. 1958. Bryocamptus stouti and Goniocyclops silvestris, two new species of copepod crustacean from forest litter in New Zealand. *Annales and Magazine for Natural History* 13: 309-314.
- MENZEL, R. 1926. Cyclopoïdes muscicoles et broméïcoles de Java (Indes Néerlandaises). *Annales de Biologie Lacustre* 14: 209-216.
- NIELSEN, L.B. 1966. Studies on the biology of Harpacticoida Copepoda, Crustacea in Danish beech leaf litter. *Natura Jutlandica* 12: 195-211.
- NOODT, W. 1956. *Attheyella* (Chappuisiella) *aliena* n.sp., ein Copepode tropischer Verwandtschaft aus Phytotelmen des Göttinger Gewächshauses. *Gewässer und Abwässer* 14: 62-69.
- PLOWMAN, K. P. 1979. Litter and soil fauna of two Australian subtropical forests. *Australian Journal of Ecology* 4: 87-104.
- REID, J.W. 1984. Semiterrestrial meiofauna inhabiting a wet campo in central Brazil, with special reference to the Copepoda (Crustacea). *Hydrobiologia* 118: 95-111.
- REID, J.W. 1993. *Fimbricyclops jimhensoni*, new genus, new species (Copepoda: Cyclopoida: Cyclopidae), from bromeliads in Puerto Rico. *Journal of Crustacean Biology* 13: 383-392.
- REID, J.W. & JANETZKY, W. 1996. Colonization of Jamaican bromeliads by *Tropocyclops jamaicensis* n.sp. (Crustacea: Copepoda: Cyclopoida). *Invertebrate biology* 115: 305-320.
- SCHAEFFER, M. 1991. The animal community: diversity and resources. In: RÖHRIG, E. & ULRICH, B. (Eds). *Ecosystems of the World, Temperate Deciduous Forests*, Vol. 7. Elsevier: 51-120.

SCOURFIELD, D.J. 1915. A new copepod found in water from hollows on tree trunks. *Journal of the Quekett Microscopical Club* 12: 431-440 + pls. 24, 25.

STURM, H. 1978. Zur Ökologie der andinen Paramoregion. *Biogeographica* 14: 1-121.

TRESSLER, W.L. 1956. Ostracoda from bromeliads in Jamaica and Florida. *Journal of the Washington Academy of Sciences* 46: 333-336.

TRESSLER, W.L. 1941. Ostracoda from Puerto Rican bromeliads. *Journal of the Washington Academy of Sciences* 31: 263-269.

TORALES, G.J., HACK, W.H. & TURN, B. 1972. Criaderos de culícidos en bromeliáceas del NW de Corrientes. *Acta Zoologica Lilloana* 29: 293-308.

UNYIAL, P.L. 2000. Some aspects of bryophyte-animal associations. *In*: MUKERJI, K.J., CHAMOLA, B.P. & SHARMA, A.K. (Eds). *Glimpses in Botany*. A.P.H. Publishing Corporation, New Delhi: 121-128.

9. Acknowledgements

Xavier Eekhout gave very useful suggestions on a previous draft of the manuscript. Two anonymous referees, through their in-depth comments, have contributed to a substantial improvement of an initial draft. Jutta Eymann's patience and affable supervision of the production of a final version of this work have made it possible. Heather Proctor did the final editing for English.

Chapter 11

Sampling the Marine Realm

by

José Templado

National Museum of Natural History (CSIC)
Jose Gutierrez Abascal 2, 20006 Madrid, Spain.
Email: templado@mncn.csic.es

Gustav Paulay

Florida Museum of Natural History
University of Florida, Gainesville, FL 32611-7800, USA.
Email: paulay@flmnh.ufl.edu

Adriaan Gittenberger

National Museum of Natural History "Naturalis"
P.O. Box 9517, NL-2300 RA Leiden, The Netherlands.
Email: gittenberger@yahoo.com

Christopher Meyer

Smithsonian Institution, National Museum of Natural History
10th and Constitution Ave, NW, Washington, DC 20560-0163, USA.
Email: meycrc@si.edu

Abstract

The marine environment is the largest ecosystem in the world and includes a vast array of habitats. Except for the Micrognathozoa and Onychophora, all animal phyla are represented in the marine realm. We comment briefly on the most commonly used sampling methods for the study of pelagic and deep-sea benthic biodiversity, but focus on sampling methods of marine benthic biodiversity in coastal areas, because >75% of known marine species are from these waters. To gain an accurate idea of the magnitude of species richness, massive collecting efforts are necessary. It is more effective to concentrate on relative small areas (100-300 km²) where diverse habitats are present, than to spread studies across extensive zones. Discrete, representative stations based on macrohabitats should be selected within the sampling area, and each station sampled by intertidal collecting, scuba diving and/or dredging. At each station complementary techniques should be deployed, including hand picking (to collect sessile and large motile species and pieces of substratum), suction sampling, brushing rocks or rubble for epibenthos, breaking hard substrates for endolithic organisms, hand-towed nets for motile species, sieving, and dredging. Rubble brushing and suction sampling have been the most effective methods for collecting small species (the major component of the marine benthic biodiversity) on hard substrates. Special techniques are required to study certain taxa, especially fragile, rare, symbiotic, or minute interstitial organisms.

Key words: sampling methods, biodiversity, coastal area

1. Introduction

The marine environment is the largest ecosystem in the world and includes a vast array of habitats. Most of the planet (71% of the world's surface) is covered by ocean waters, with an average depth of ~3,800 m. Oceans thus hold an overall volume of some $1.370 \times 10^6 \text{ km}^3$ (97% of the water on the planet) capable of supporting life. However, surprisingly, species diversity appears to be far lower in the sea (around 250,000 known species) than on land (between 1.4 and 1.7 million known species), probably because dispersal is more wide-ranging in water than on land and genetic connectivity is maintained over vast expanses (but see Paulay & Meyer, 2006). This may be partly the result of broader geographic ranges and consequently lower rates of speciation for marine versus terrestrial species. Furthermore marine environments are physically much less variable in space and time than terrestrial ones. Finally, the most diverse group of macroorganisms, the insects (within the animal kingdom) and the angiosperms (within the plant kingdom) are largely restricted to terrestrial and freshwater environments. Nevertheless, the diversity of major lineages (phyla and classes) is much greater in the sea than on land or in freshwater, reflecting the ocean as the cradle of life.

Of the 34 currently recognized animal phyla (Table 1), all except two occur in oceanic waters: 16 are exclusively marine; 16 occur in both marine and freshwater, while only one phylum is exclusive to freshwater (Micrognathozoa), and one restricted more or less to land (but with marine fossil record: Onychophora). Many exclusively marine animal phyla are relatively obscure and have few species. The major exception is the Echinodermata, with 7,000 described species. A number of other major animal phyla including the cnidarians, sponges, as well as the non-metazoan brown and red algae (Phaeophyta and Rhodophyta, respectively) are largely marine, each with only a small number of non-marine (usually freshwater) representatives. A summary for the world view of species has been published by Chapman (2009), while a complete review of marine species was given by Bouchet *et al.* (2006).

Although knowledge of marine biodiversity has increased enormously in the past few decades, marine life remains far less well documented than terrestrial biodiversity. The main reason is that most of the marine biosphere is difficult to access. The oceans are tantalizing from the shorelines, but their great depths and remote reaches make them challenging to study. Study of any part below the top few meters requires specialized equipment and is expensive and time consuming. Knowledge of most of the sea is thus based on remote-sensing and sampling techniques, and remains limited and less precise. As these techniques become more sophisticated, so does our understanding of marine ecosystems, especially for areas away from the coastal zone.

Although research on biodiversity has greatly increased in recent decades, these efforts are dominated by studies on terrestrial environments. Between 1987 and 2004, only 9.8% of published research dealt with marine biodiversity (Hendriks *et al.*, 2006). This severe imbalance is also evident in international programs.

Table 1. Extant Animal Phyla.

Phylum	Notes	Marine	Holoplanktonic members
Porifera	sponges	yes	no
Placozoa	Tricoplax	only	no
Cnidaria	hydroids, jellyfish, anemones, corals	yes	yes
Myxozoa	aff. Cnidaria?	yes	as parasites
Ctenophora	comb jellies	only	yes
Orthonectida	“Mesozoa”	only	no
Dicyemida	“Mesozoa”	only	no
Chaetognatha	arrow worms	only	only
Platyhelminthes	flatworms, polyphyletic?	yes	yes
Gastrotricha	minute worms	yes	yes – semi-pelagic
Entoprocta	= Kamptozoa	yes	no
Gnathostomulida	minute “jaw” worms of hypoxic habitats	only	no
Rotifera	=Syndermata, incl. Acanthocephala	yes	yes
Micrognathozoa	Microscopic worms, Limnognathia	no	no
Cycliophora	lobster lip worms, Symbion	only	no
Nemertea	ribbon worms	yes	yes
Sipuncula	peanut worms	only	no
Annelida	segmented worms, incl. Pognophora & Echiura	yes	yes
Mollusca	Snails, clams, chitons, squid	yes	Yes
Phoronida	horseshoe worms	only	no
Bryozoa	= Ectoprocta, moss animals	yes	no
Brachiopoda	lamp shells	only	no
Nematoda	round worms	yes	as parasites
Nematomorpha	horse hair worms	yes	no
Kinorhyncha	minute “mud dragons”	only	no
Priapula	carnivorous worms	only	no
Loricifera	“girdle-wearers”, minute	only	no
Tardigrada	water bears	yes	no
Onychophora	velvet worms	no	no
Arthropoda	Insects, myriapods, crustaceans, spiders, incl. Pentastomida	yes	yes
Xenoturbellida	Xenoturbella	only	no
Echinodermata	stars, urchins, sea cucumbers	only	yes
Hemichordata	acorn worms	only	no (presumably)
Chordata	tunicates, vertebrates	yes	yes

For instance, only about 10% of the First Open Science Conference of the Diversitas Programme (November 2005 in Mexico) that dealt with biodiversity science, addressed marine biodiversity (Hendriks *et al.*, 2006). This disproportionately small research effort on marine biodiversity is in sharp contrast

to the large phyletic diversity in the oceans compared to land. The phyletic and genomic richness of the ocean also remains an underutilized resource for biotechnology, pharmacology, and other resources.

The global inventory of the marine realm is far from complete, especially for minute and rare species, and commensals and parasites, which together represent the largest number of species in complex ecosystems (Bouchet *et al.*, 2009). Besides, a rich fauna of some neglected habitats still remains overlooked (Denis & Alfhou, 2004; Mendoza *et al.*, in press). Despite this deficit, most integrated studies on marine biodiversity focus on a few well-known indicator taxa (fishes, corals), neglecting most other groups, often because of a reputation of being too diverse or difficult for non-specialists. Nevertheless, close to 1,800 new marine species are described each year (Bouchet *et al.*, 2002).

The aims of this chapter

A complete review of methods for the study of all marine biodiversity is outside the scope of this chapter. The most commonly used sampling methods for the study of the pelagic and deep-sea benthic biodiversity are commented upon briefly, and we focus on sampling methods for marine benthic biodiversity in coastal areas, where >75% of recorded marine biodiversity is concentrated. Microscopic organisms are also outside the scope of this chapter. We principally focus on the study of marine metazoans and macroscopic seaweeds.

2. Pelagic Biodiversity

The oceanic pelagic zone is dominated numerically by plankton in euphotic surface waters. Plankton are by definition drifting or weakly swimming organisms, and include a wide range of small to microscopic animals, protists and bacteria. Free-swimming pelagic organisms are collectively termed nekton. Both tend to concentrate along major circulation currents (gyres), contact zones and upwelling regions, and this causes significant local variations in abundance and diversity.

The marked vertical gradients of light, temperature, pressure, nutrient availability and salinity within the pelagic realm create vertical structuring of pelagic species assemblages into several depth zones that tend to fluctuate in time and space. Some components of the epipelagic and mesopelagic nekton and even plankton perform remarkable diel migrations: ascending to surface waters at night to feed and descending, sometimes over 1 km, during the day (Groombridge & Jenkins, 2002). With few exceptions, the only food source for organisms in the aphotic zone is the 'rain' of organic matter (faeces, moulted crustacean exoskeletons, corpses) from the euphotic zone.

2.1. Plankton

Plankton refers to the assemblage of passively floating, drifting, or somewhat motile organisms occurring in the water column, primarily comprising bacteria, protists, tiny algae, small animals, and developmental stages (eggs, larvae, etc) of larger organisms. Planktonic organisms range in size from microbes (under 0.001 mm) to jellyfish with gelatinous bells >1 m in diameter and tentacles up to

10 m long. Plankton can be loosely grouped as producers (phytoplankton, including prokaryotic and eukaryotic algae) and consumers (zooplankton as well as heterotrophic bacteria and protists). Many protists are both producers and consumers, and may account for a large proportion of primary production.

Planktonic assemblages are strongly affected by physical and chemical characteristics of water masses on scales ranging up to entire ocean circulations. The vertical structure of the water column is also important, especially the depth of the mixed layers, as this influences nutrient and light levels that control phytoplankton growth and assemblage composition. Although plankton is most abundant in the photic zone, it is found at all depths. At least 40% of the world's primary production occurs in the open ocean, and much of this production is initially consumed by planktonic crustaceans (mainly copepods). These organisms are relatively well studied, and many have been assumed to be cosmopolitan.

In surprising contrast to their globally high biomass and productivity, the diversity of planktonic organisms is low, with only ~3,700 described species of holoplanktonic zooplankton (Groombridge & Jenkins, 2002). This has been attributed to the dynamic mixing of oceans limiting geographic differentiation. Nevertheless most animal phyla are represented in the plankton as many benthic species have a planktonic larval phase. Zooplankton is dominated numerically and in total mass by animals that spend their entire lives as plankton. Such animals are termed holoplankton, while temporary residents of the plankton (such as eggs and larval forms) are called meroplankton. Of the 34 marine animal phyla only 13 have representatives in the holoplankton (Table 1).

Sampling methods

There are many comprehensive books on sampling methods for plankton (*e.g.* UNESCO, 1968; Harris *et al.*, 2000; Goswami, 2004; Suthers & Rissik, 2009, among many others). Towed nets are still the primary means of collecting many plankters. Plankton nets vary in size, shape and mesh size but all are designed to capture drifting or relatively slow-moving organisms retained by the mesh. The simplest nets are conical in shape, with a wide mouth opening attached to a metal ring and a narrow tapered end fastened to a collecting jar known as the "cod end". This kind of net can be towed vertically, horizontally, or obliquely through the desired sampling depths. Such nets will filter water and collect organisms during the entire towing period. More sophisticated nets can be opened and closed at selected depths, and a series of such nets may be attached to a single frame to allow sampling of different discrete depths during a single towed operation. Analyses of the collected samples permit a more detailed picture of the vertical distribution of plankton.

Zooplankton pumps can also be used; these pull water from a selected depth and pass it through a mesh. The Moored Automated, Serial, Zooplanktic Pump (MASZP) is designed to make moored, time-series collections of small planktonic species.

Each discrete plankton sample is usually filtered over a portion of mesh, which is covered by another piece of mesh, and the two strips are wound together on a

spool residing in a preservative bath for *in situ* storage. The material collected is later washed from the mesh, and the organisms sorted by hand for microscopic identification. To expedite sample processing new technologies have been developed for recognizing species in mixed populations through species-specific immunofluorescent markers (Garland & Butman, 1996).

In recent decades attempts have been made to observe zooplankton directly in the field, by scuba diving or from submersibles. Such direct sampling has enabled the collection of delicate species, especially large-bodied jelly-plankton (colonial radiolarians, medusae, ctenophores, salps, etc.) that were undersampled or destroyed using traditional methods, but are important components in pelagic environments. Recent development and refinement of acoustic and optical technology has also enabled better quantitative estimates of biomass and the distribution of the more mobile members of the plankton. Many of the holoplanktonic species can be identified by acoustic or optical images. Autonomous sampling buoys, autonomous underwater vehicles (AUV, essentially oceanographic robotic systems), autonomous surface vehicles, gliders, drifters, among other, are also being used in the study of the plankton.

New instruments, such as the Video Plankton Recorder (an underwater video microscope attached to a Remotely Operated Vehicle) are bringing new insights to the study of these small animals. Today global-scale analytic methods for all marine zooplankton groups are being developed using new technologies, including molecular, optical and acoustical imaging, and remote detection. By 2010 the coordinated multinational effort Census of Marine Zooplankton (<http://www.cmarz.org>; within the Census of Marine Life) seeks to complete both the morphological and DNA barcode analyses of at least the ~6,800 described species of marine metazoan and protozoan plankton. DNA barcoding is underway in laboratories in Japan and the USA (O'Dor & Gallardo, 2005), including DNA barcoding of existing specimens in collections as well as identified cryptic species among cosmopolitan groups. The Census of Marine Zooplankton will provide the first global synthesis of the biodiversity and biogeography of the species that make up the greatest animal biomass on the planet. It is likely to double the number of known zooplankton species and will provide DNA barcodes for their reliable and rapid identification. On the other hand, Venter *et.al.* (2004) identified at least 1,800 new species of microbes using "whole-genome shotgun sequencing" to microbial populations of the Sargasso Sea.

2.2. Nekton

The nekton comprises the large, pelagic, marine animals able to move independently of water currents. Fish make up the largest fraction of the nekton, but some crustacean (some euphausiids, shrimps, and swimming crabs), many cephalopods (such as squids), marine turtles, and marine mammals are also important nektonic components. There are ~1,200 nektonic fish species compared with ~13,000 coastal ones, >300 species of nektonic cephalopods, and five species of marine turtles (Angel, 1993). Wholly aquatic mammals are confined to two orders, the Cetacea and the Sirenia. The cetaceans comprise some 78 species, all except five marine, distributed throughout the world's seas.

It has generally been assumed that pelagic biomass below the euphotic zone is low. Recent studies based on a variety of surveys have indicated that the global biomass of tropical mesopelagic animals may be surprisingly high (Groombridge & Jenkins, 2002). Around 160 fish genera in 30 families are recognized as important components of the mesopelagic fauna (usually small species less than 10 cm in length).

Study of the pelagic fauna requires the use of expensive high-seas research vessels (Figure 1A). The sampling methods are mainly those employed in fisheries and oceanography. In fact, nektonic species are usually studied within the branch of marine science that is called “fisheries oceanography”. There is an extensive bibliography and entire journals (e.g. *Fish Biology and Fisheries*) devoted to this discipline. Tagging and real-time tracking of many large pelagic animals using new technologies are making it possible to provide unprecedented estimates of the global distribution and abundance of the largest animals in this realm.

A review of the techniques to study this pelagic fauna is outside the scope of this chapter. We refer to comprehensive publications on the subject such as those of Roper & Rathjen (1991), Sibert & Nielsen (2001), Gabriel *et al.* (2007), among many others.

3. Deep-sea biodiversity

Around 50% of the Earth's surface is covered by ocean >3,000 m deep. Despite their enormous volume, the deep oceans were initially thought to be relatively simple ecosystems that made little contribution to global species diversity. However thorough quantitative samples of infauna have shown that deep sea is surprisingly species rich, even rivalling the diversity of coral reefs (Grassle & Maciolek, 1992). As more of the deep-sea is surveyed with increasingly sophisticated gear, it is apparent that the environment itself, in terms of substrate features and/or current regime, is more variable than was once thought. Environmental diversity in the form of microhabitats (small areas having slightly different characteristics) can in itself lead to higher diversity in animals. Indeed, the deep-sea benthos has a patchy distribution, with significant aggregations of animals that have been detected in different taxonomic groups on scales ranging from centimeters and meters to kilometers. This patchy distribution makes representative samples difficult to obtain for assessing biomass and species diversity of deep-sea animals. In addition, discoveries during the past decades have shown that there are some deep habitats with unusual benthic diversity, such as seamounts and rock outcrops, submarine canyons, beds of manganese nodules, deep-water reefs of ahermatypic corals, hydrothermal vents, cold seeps, and other chemosynthetic ecosystems such whale skeletons or sunken wood.

Sampling methods

Open-sea and deep-water work imposes procedures substantially different from those required for near-shore surveys. Deep-sea sampling is costly and time-consuming. Collecting a sample from 8,000 m depth with towed gear, for

example, requires a very large winch with at least 11 km of cable in order to allow for the towing angle. It takes up to 24 hours to let out that much wire, obtain a sample, and retrieve it. Cost of shiptime can easily exceed 20,000 € per day.



Fig. 1. Surface based sampling. A. French research vessel Alis of the IRD center; B. Dredge haul off the coast of Cortes; C. Trawl haul from the deep; D. Off shore plankton tow. (Photo A - C by Panglao Marine Biodiversity Project 2004; D by Chris Meyer).

Holmes & McIntire (1984), also provide a guide to relevant publications on the study of marine benthos until 1984, while Gage & Tyler (1991) review methods to study organisms of the deep-sea floor, giving detailed description of traditional gears and sampling techniques. Wenneck *et al.* (2008) review recent technological advances. An overview of organization and procedures of a survey of the deep-water fauna is given by Richter de Forges *et al.* (2009).

Comprehensive surveys have utilized trawls, bottom sledges, dredges, grabs, box samplers and corers, as well as a variety of acoustic and optical approaches. Large trawls and nets give snapshots of life sampled across a mile or longer stretch of bottom. In contrast box cores deployed from surface vessels provide samples that are precisely spaced and come from a single spot. A specialized deep-sea fauna living in the lowest strata of the water column are bottom-dependent, swimming animals that may perform daily or seasonal vertical migrations above the bottom, the supra- or hyper-benthos. Suprabenthic fauna essentially consists of crustaceans from the superorder Peracarida (amphipods, cumaceans, isopods and mysids). The suprabenthic sled was designed for such

near-bottom sampling operations with a number of nets that fish at different heights above the substrate.

Sampling the deep-sea benthos from surface ships does not provide a close-up view of the system. To understand relationships of organisms with the environment *in situ* studies are useful, as well as the ability to return to the same spot. This can be achieved with manned or unmanned vehicles equipped with precise navigational capabilities and visually operated sample manipulators and/or video recorders. Submersibles or remotely operated vehicles (ROVs) are the only way to: 1) precisely sample small-scale features such as sediment forms, rocks, or individual organisms; 2) sample repeatedly with respect to specific experiments or features of the bottom over time spans up to several years; 3) push sampling devices and other instruments into the bottom without disturbance of the sediment-water interface; 4) locate objects and sample in complex rocky topography where tethered devices could not move over the bottom without encountering obstacles; 5) sample specific layers in the water column; and 6) sample delicate organisms that are destroyed by traditional sampling gear.

Submersible-based sampling was accelerated with the use of the *Alvin* by the United States and *Archimède* and *Cyana* by France during the French-American Mid-Ocean Underwater Study (FAMOUS) project in the 1970's (Heirtzer & Grassle, 1976). The discovery in 1978 of new and abundant sea life around deep-sea hydrothermal vents near the Galapagos Islands greatly increased research in this special environment as well as the use of manned submersibles. Most submersibles require a mother ship to assist in moving it to the dive location and for recharging energy sources, checking equipment, and housing diving personnel. In a normal operating dive a deep-sea submersible will stay submerged for 6 to 10 hours, in waters up to 3 km deep (the rate of ascent and descent is about 2 km/hour). It can move over the bottom at a speed of 1 to 2 knots and can cover a path of several kilometres.

Several types of unmanned, remotely operated vehicles (ROVs) or autonomous underwater vehicles (AUVs) can carry a variety of recording equipment to document deep sea organisms. These can be remotely operated from surface vessels, or pre-programmed to do their jobs independently of direct human control. Some have manipulators that are able to take samples. Clarke (2003), Chave (2004), or Divas (2004), among many others provide glimpses of deep sea exploration by submersibles.

4. Benthic biodiversity in coastal areas

Marine biodiversity is much higher in benthic than pelagic systems, and is also thought to be higher in coastal waters rather than in the open/deep sea, since there is greater range of habitats near the coast (but see Grassle & Maciolek, 1992). Continental shelves cover <10% of the ocean's area, but contain most of the documented marine biodiversity. In fact, more than 75% of known marine species are concentrated in coastal areas, especially in the tropical regions (Bouchet, 2006). For this reason and because key coastal habitats are lost globally at rates 2 to 10 times faster than those in tropical forests (Reaka-Kudla,

1997), special attention and effort must be paid to their study and conservation. The highest coastal marine species diversity is in the Indo-Malayan archipelago and decreases both longitudinally and latitudinally from there (Hoeksema, 2007).

Representative coastal benthic habitats include:

- **Mangroves** - Mangroves are a “hybrid” terrestrial/marine ecosystem, unique in that terrestrial organisms occur in the canopy and marine species at the base (Figure 2). Mangroves, or mangals, are a diverse collection of shrubs and trees that live rooted in soft, intertidal marine sediments. Mangroves dominate deltaic and low coastal areas, and are restricted to the tropics and subtropics. Global area occupied by mangroves slightly exceeds 180,000 km², covering 60-70% of the tropical and subtropical coastline (Groombridge & Jenkins, 2002).
- **Coral reefs** - Coral reefs are accumulations of solid calcium carbonate matrix developed by stony corals and co-occurring organisms. Coral reefs are tropical shallow water ecosystems, typically with very high biodiversity, although they are also known (but are more limited and less diverse) in some deep and high latitude environments. They dominate shallow, clear, warm, nutrient-poor waters with limited terrestrial sediment runoff in the tropics. The global extent of coral reefs has been estimated at around 285,000 km² (Groombridge & Jenkins, 2002).
- **Seagrass meadows** - Seagrasses are flowering plants adapted to shallow marine and estuarine environments across a wide range of latitudes. About 58 living species are recognized. They occur from the littoral region to depths of 50 or 60 m and cover extensive areas on shallow soft substrates. Globally seagrass beds cover between 200,000 and 500,000 km² of the continental shelves (Spalding *et al.*, 2003).
- **Rocky bottoms** - Rocky substrates can be of biological or geological origin. The former are referred to as reefs and include coral reefs, the latter are characteristic of tectonically active areas such as convergent margins and volcanic islands. Rocky bottoms provide considerably physical complexity and tend to harbour diverse biota. Different habitats and complex communities are usually identifiable and can be characterized according to a combination of physical and biological attributes.
- **Kelp forests** - Kelp forests are subtidal macro-algal communities dominated by kelps (large brown algae of several genera, including *Laminaria*, *Saccorhiza*, *Ecklonia* and *Macrocystis*) in cold temperate to subtropical regions. They form distinctive lower intertidal to shallow subtidal communities, especially in areas with currents or surf. Kelps usually require hard bottom for attachment, and grow off rocky shores to depths of 20-40 m. The net primary production of kelp forests is comparable to tropical rainforests.
- **Soft sediments** - Soft sediments are the most widespread coastal marine ecosystem type. Virtually the entire seabed away from the coastline is covered by marine sediments.

- **Anchialine caves** - Anchialine caves are defined as bodies of hyaline water with more or less extensive subterranean connections to the sea. They show noticeable marine as well as terrestrial influences. Such habitats include land-locked open pools, pools in caves, and entirely submerged cave passages, which are known to harbor a number of fascinating organisms, such as the primitive crustacean class Remipedia.

4.1. Planning

Most of the general methods and procedures described here for fieldwork in coastal marine areas are being deployed in the Moorea Biocode Project, an effort to build the first comprehensive, voucher-based, genetic inventory of all non-microbial life in a tropical ecosystem (<http://www.mooreabiocode.org>). These general methods and procedures are also those basically employed in a long term project conducted by a group led by Philippe Bouchet (National Museum of Natural History of Paris), the purpose of which is to address the magnitude of species richness in coral reefs and associated environments by selecting sites through the Indo-Pacific biodiversity gradient (see Bouchet *et al.*, 2002), including surveys at Lifou in Loyalty Islands, 2000, Rapa in southernmost French Polynesia, 2002, Koumac and Touho in New Caledonia, 1992, Panglao in the Philippines, 2004, and SE corner of Santo in Vanuatu Islands, 2006. While these large-scale biodiversity survey expedition(s) usually are carried out over a relatively short time interval, planning for them can take years of preparation, including obtaining permits, coordinating participant travel, etc. (for more information see the first chapter on the concept, challenges and solutions of planning an ATBI+M).

4.1.1. Choosing the area and stations

If the objective of an All Taxa Biodiversity Inventory is to maximize the potential biodiversity encountered, then the selected site should have high habitat heterogeneity. It is most effective to choose a relatively small coastal area (no more than 100-300 km²) so that all of it is accessible within one hour from the field lab by boat or vehicle, at a location that includes the greatest diversity of habitats characteristic of the region. Covering more extensive areas from a shore-based field lab becomes logistically difficult and inefficient. The depth range surveyed should range from the intertidal fringe to about 50 m when limited to SCUBA, or to greater depths (e.g. to 100 m) when boat-based sampling via dredges, trawls, and grabs is available. A number of discrete sampling stations should be selected, spanning the range of habitats, at each of which a broad range of sampling techniques are utilized. Background information, including a planning visit to the area and preliminary sampling, are very useful in scoping out a region, selecting the survey site, as well as choosing some of the stations to be sampled.

Importantly, the selected site will need to have sufficient facilities and infrastructure: boats, support staff, diving support, meals for the participants, etc., in place by the time the project starts. It is necessary to establish a field lab in a

place from where teams can go sample (mainly in small boats) and return for the sorting process.

4.1.2. Defining the task

An ATBI is a tall order in the marine realm because of the diversity of organisms present. Thus it is important to define the taxonomic scope of the project and plan accordingly. It is not feasible to study all groups of organisms in an area. Most early integrated studies on tropical marine biodiversity have focused on a few indicator taxa (especially fishes and corals – both groups that live largely exposed and are thus visually immediately apparent) and neglected others, because of logistic constraints and sampling and taxonomic challenges. The greatest challenge for marine ATBIs is that most taxa live concealed, and this “cryptofauna” harbors most of the species richness. Useful additional taxa to include in a limited ATBI include seaweeds, sponges, octocorals, mollusks, decapods, polychaetes, bryozoans, echinoderms and tunicates.

These include most of the other macrobiota that lives exposed, as well as the large-bodied, conspicuous, or taxonomically relatively well-known groups. The Moorea Biocode project includes most taxa with a goal to cover most macrofauna (>10 mm), a good portion of mesofauna (1-10 mm), and explore microfauna (<1 mm).

In an ATBI, sampling at any station is normally qualitative or semi-quantitative, with collecting effort usually proportional to species richness and habitat heterogeneity as perceived empirically in the field. Quantitative sampling is not nearly as effective as qualitative sampling carried out by a specialist at capturing maximum biodiversity. For instance, in parallel studies of fore reef decapod diversity in Moorea, a semi-quantitative approach sampling replicate dead coral heads yielded 50 species, whereas specialized collecting in the same habitat over the same amount of time recovered 210 species, with 23 in common between the methods (Plaisance *et al.*, in press).

4.1.3. Building a team

A massive collecting effort requires a team composed of biodiversity specialists and support personnel. Participants need to include taxonomic experts, who contribute both by planning and participating in collecting thus contributing their expertise in finding species, as well as in sorting catches to morphospecies (see below). Support personnel help with field work (boats, diving, collecting), processing samples, photography, and the general operation of the expedition. Volunteers and students can help and gain as well as provide expertise, while local fisherman can provide field knowledge about habitats, organisms, and effective sampling methods. A major effort can easily include more than 50 participants.

4.1.4. Time required

About 500 person-days of field work can provide reasonable coverage for 2-4 phyla in a high diversity area. Typical efforts in such medium scale expeditions take 4-6 weeks of field work with 10-20 field workers. It is also useful to repeat such an effort in a different part of the year, because many organisms are annual or have seasonal cycles.

4.2. Sampling methods

Below we give an overview on general procedures for fieldwork in marine coastal areas. A detailed description of all gear and techniques is beyond the scope of this chapter and we recommend more specialized literature or a handbook on methods for the study of marine benthos, such as Holme & McIntire (1984). A useful picture on sampling design in a coastal area is provided by Bouchet *et al.* (2009)

4.2.1. Intertidal sampling

The coastal intertidal is a rich and easily accessible habitat, as no snorkelling or diving skills are required; thus most taxonomists can pursue field collecting there. Intertidal habitats include rocky shores, reef flats, sand and mud flats, beaches, seagrasses, and mangroves. Effective methods include visual searches for larger organisms that live exposed or under rocks, yabbie-pumping for burrowing species and their associates, digging and sieving for soft bottom infauna, sifting through algae, using baited traps, hand dredges, and/or examination of residues of rock/algal wash.

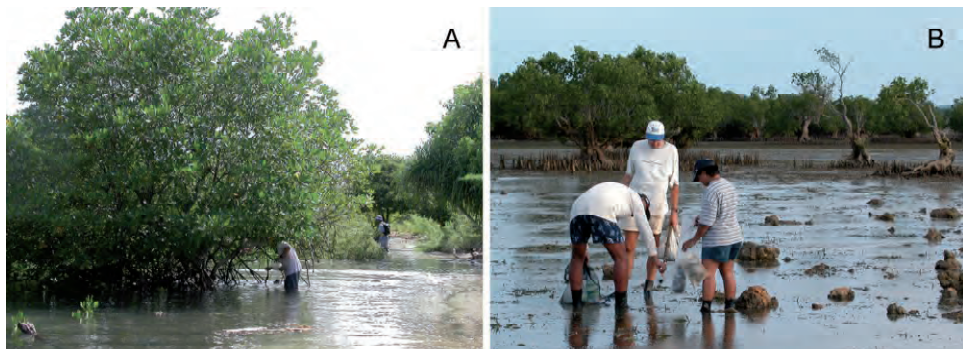

Fig. 2. Shore based sampling. A. Collecting in mangrove; B. intertidal sampling on mudflat and seagrass bed. (Photos by Panglao Marine Biodiversity Project 2004).

Most intertidal sampling happens at low tide. It is useful to also collect during night low tides, as many animals are nocturnally active, are buried in the sediment during the day, and much more easily found at night when they emerge. Tides during the new and full moon periods are the largest, but some habitats (high intertidal, estuarine, river/mangrove transition) do not require extreme tides to be properly sampled.

4.2.2. Underwater collecting

Scuba diving and/or snorkelling allow very selective sampling and choice of specific places and microhabitats. Underwater sampling is also very useful for observing species in their natural state and for obtaining more detailed information about the structure of benthic communities and other valuable ecologic data.



Fig. 3. Scuba based sampling. A. Underwater brushing for micromolluscs; B. Brushing rubble for cryptic species; C. Hand collecting among rubble and coral on forereef; D. Investigating gorgonians for associated mollusks; E. ARMS pre-deployment; F. Vacuum set-up; G. Vacuum suction in operation. (Photos A., D. & G. by Panglao Marine Biodiversity Project 2004; B. by Jenna Moore; C. by Sea McKeon; E. by Rusty Brainard; F. by Chris Meyer).

The most common methods used in diving are:

- **Hand collecting of motile species.** Larger motile organisms (>1 cm) are often best collected by hand, or by hand-held devices like nets or slurp guns. Although some motile species live exposed on the bottom and are readily encountered, others live concealed in the substratum. On hard bottoms turning loose rocks reveals a broad array of cryptofauna, as does searching in soft sediments by fanning or just by feeling with hands. Crevices and small caverns are also good places to search for cryptofauna. Night diving is very useful, because numerous cryptic, motile species emerge at night, making them easier to find and collect. Scuba hand sampling is usually also an effective way to look for symbiotic associates on larger sessile and mobile organisms like sponges, cnidarians, and echinoderms (Fig. 3D).
- **Hand-towed nets.** Using hand-towed nets in seagrass meadows is done to collect the motile fauna that live on the leaves. Nocturnal sampling is recommended, as the number of specimens collected may be up to five fold higher in nocturnal samples than those obtained during the day (pers. obs., JT).
- **Hand collecting sessile biota.** Hard bottoms have a rich sessile flora and fauna. While some sessile species are large, exposed, conspicuous and thus readily noticed and collected, many more are small, cryptic, encrusting, living in crevices, in the reef matrix and under rocks. Thus, as for mobile fauna, sampling under rocks and in crevices is important to get a representative coverage of the sessile fauna. A hammer and chisel, small drywall saw, scrapers, and clippers are useful tools for removing sessile organisms.
- Many sessile species have very useful field morphological characters, such as their growth form, shape, color, etc., that can be rapidly changed or lost upon collection or fixation. Some are so fragile that their form and even color can alter rapidly with collection (e.g. sponges, ascidians), while encrusting forms (like many bryozoans, worms, etc.) can be difficult to collect intact because of their broad attachment to solid substrata. Thus it is especially important to photodocument sessile species *in situ*. It is best to take both whole colony and close-up (such as 1:1 magnification) photographs before disturbing them, and to keep good records of form, color, and pattern in the field. Many sessile species are associated with mobile micropredators or symbionts, like nudibranchs and crustaceans, and it is important to search for these before disturbing the host.
- **Suction sampling.** An over-sized mechanical aspirator is an efficient tool for sampling small organisms on hard and complex substrates, and can be equally rewarding on soft bottoms (Fig. 3F & G). Aspirators can be powered by compressed air from one or more SCUBA tanks, or by motorized pumps. Depending on the size of the unit, one or two divers are needed to operate it. Brushing the vacuumed area can facilitate dislodgement of tenacious motile fauna. An area of about 5 m² can be sampled in one effort, depending on depth and the rate at which filters become clogged.

- **Brushing.** Brushing fine debris and associated motile biota from rubble into large nets or mesh-lined brushing baskets is an effective way to collect micromolluscs, crustaceans, and other invertebrates (Fig. 3A). The brush bristles should be soft enough not to damage the specimens, but hard enough to dislodge them. The opening of the collecting device should be closed after each brushing if possible to prevent more motile specimens (e.g. shrimp) from escaping.
- **Extractive sampling.** Most motile species are small and cryptic, difficult to notice, and live concealed within complex benthic communities. This cryptofauna represent the bulk of the reef biodiversity (Dennis & Aldhous, 2004). An effective way to sample these is to take samples of their habitats (rubble, soft sediment, algae, debris, sessile organisms, etc) to the lab and extract the organisms from these bulk samples. Pieces of rubble can be collected into buckets or bins underwater, transported back to the lab, and broken apart and picked over (Fig 5B). Soft sediment can be sieved or picked over for microfauna (Fig 5A). Weak (~10%) solution of ethanol in seawater, isotonic MgCl₂ and other narcotizing agents can be used to extract animals from a variety of substrata by letting the sample soak for a few minutes, then shaking a decanting over a mesh. Letting disassembled substrata sit in a bucket for a day or more provides an alternate extracting method. As the oxygen is used up, many organisms crawl out and up to the air-water interface, where they can be readily picked. This is an especially useful way to collect long worms that are otherwise difficult to extract whole. Alternatively, the broken rubble can be placed in a tray with a thin film of water. As the rubble drains and dries out, some animals retreat to the shallow layer of water accumulating in the tray.
- **Deployed Collecting Devices.** A useful method for inventorying especially small sessile organisms in an area is to deploy settlement plates and to periodically check these for species. In temperate areas, it is important to check plates in each season. If they cannot be deployed for a whole year, then deployment in late spring to early summer is ideal in the temperate zone. Most species become recognizable on the plates as soon as 2 weeks after deployment, but become more easily identified after one to three months. Settlement plates are extensively used in marine ecology, with considerable standardization. Thus it is useful to check the literature for settlement plate designs proven to be useful for scoring the flora and fauna in the region, and for which comparative data may be available. For example grey, 14x14 cm PVC plates, deployed horizontally at 1 m depth, are used for biodiversity monitoring by a large variety of organizations along Western Europe, NW and NE America, Hawaii, and New Zealand. Because settlement plates are usually hanging on lines that are attached above water, they can be easily retrieved. A small sized plate is also easy to photograph in the lab under controlled conditions, and can be preserved whole in ethanol if desired. If ethanol is not easily available, one can also use “sun-dry” plates, which still enables the identification of many Bryozoa, sponges, bivalves, barnacles, and some algae, ascidians, tube-worms and corals. When deploying several plates per locality, and scoring the species compositions per plate, one can

use a species accumulation plot to check whether many more species are still to be expected if one would deploy more plates, or whether most potentially-associated species have been sampled.

- Automated Reef Monitoring Structures (ARMS) that have been developed by the CReefs consortium (<http://www.creefs.org>) as part of the Census of Marine Life are a novel deployable method for quantitatively sampling marine diversity of not only sessile, but also mobile fauna. ARMS are a standardized stack of large settling plates (9 x 9 inches) separated by alternating fully open or compartmentalized layers (Fig. 3E). The ARMS are attached to a basal plate and anchored to the bottom. On CReefs efforts they are deployed at a standard 15 m depth on forereef habitats, currently for one year intervals, although tests are ongoing to determine the effects on community structure with longer intervals. Upon retrieval the ARMS are disassembled and each plate (top and bottom) are photo-documented, mobile fauna separated, and sessile and clinging fauna scraped clean. At this time there are over 200 ARMS deployed worldwide. Current efforts are aimed at developing technologies to enable efficient molecular sampling of this diverse community in parallel with traditional techniques.

In a dive intensive ATBI it is useful to have two groups sampling each station, thus allowing the use of all major methods per station. One group (ideally in a separate boat) pursues bulk sampling (brushing baskets, suction sampler), with experienced divers, but who do not need to have detailed knowledge of the organisms. A second group comprised of taxonomic specialist collectors focuses on hand collecting to take advantage of their experience and better search images for target species groups.

Having marked jars, bags, and coolers on the dive or in the boat allows separation of collections from distinct habitats and microhabitats, and tracking samples. It is useful to keep animals that interfere with each other in separate containers: some molluscs slime (a problem in closed containers), crabs rip, and many nudibranchs and flatworms poison.

4.2.3. Trawling, towing and dredging

Smaller dredges, grabs, traps, plankton nets, and other sampling equipment can be deployed from small boats (Fig. 1D). These equipment can be sufficiently small so that expensive research vessels are not necessary for their deployment in smaller efforts (although the addition of a major research vessel greatly enhances the potential of ship-based sampling). Small boats can be rigged with a modified arm and pulley system, and gear retrieved with a motorized line hauler. Local knowledge can be quite helpful in determining trap design (Fig. 4A) and locations (see below), and can be hired to assist in such sampling or to set and retrieve baited traps.

Local fishermen can be useful sources of uncommon or larger species, especially those of commercial importance (e.g., mollusks, crustaceans, fishes). They may also use specialized techniques that would not otherwise be utilized by the survey, and can be a useful source of interesting bycatch. For instance, both

tangle nets and lumun lumun (Fig. 4B) were adopted from traditional Filipino fishermen and used effectively in Panglao (Ng *et al.*, 2009) and subsequently adopted during the later Santo expedition. Fishermen also have a wealth of local knowledge about habitats, natural history, tides and currents that can greatly facilitate planning the site, station choice, and method selections.



Fig. 4. Artisanal sampling. A. Deployment of locally made traps; B. Retrieval of lumun lumun off Balicasag Island. (Photos by Panglao Marine Biodiversity Project 2004).

4.2.4. Meiofaunal sampling

Marine sediments hold an abundance of microscopic life, the smallest of which attach to individual sand grains or live in the interstices between grains. A variety of bacteria, archaea, and protists share this habitat with minute metazoans, the meiofauna. Meiofauna ranges from <0.1 to a few mm in size, and is a major component of seabed ecosystems, particularly in the deep sea. About half of the animal phyla are represented in the meiofauna, and some (*e.g.*, Loricifera, Kinorhyncha) are confined to it. Nematodes are typically the most numerous component, with harpacticoid copepods, foraminiferans, and various worm groups also abundant.

Because the density of the interstitial organisms can be high, smaller samples are usually adequate and can be examined in their entirety. Simple corers, small diameter (5-10 cm) metal or plastic tubes driven into the sediment by hand or, if necessary, with the aid of a hammer, are the simplest and most effective sampling tools. If the vertical distribution of the fauna is to be studied it is essential that the sample should be divided into appropriate sections immediately on collection, since change within the sample can produce rapid alterations in the vertical distribution of the fauna.

In order to examine and count meiofauna, the samples are usually brought back to the laboratory for extraction from the sediment. Preservation and extraction techniques depend on the type of taxa studied and level of identification desired. "Hard" meiofauna, such as nematodes, copepods, ostracods, and kinorhynchs remain identifiable after rough preservation within the sediment using 4% formaldehyde, but are of little value for genetic studies if formaldehyde is used. "Soft" meiofauna such as turbellarians and gastrotrichs require live extraction. Extraction methods also vary according to the type of sediment and depend on whether extraction is to be qualitative (to obtain representative specimens) or

quantitative (to extract every organism possible for detailed count). Techniques of extraction fall into two categories: 1) those like decantation, elutriation and flotation, which rely on density and the differential rates of settlement between organisms and sediment particles and are suitable for both living and preserved material, and 2) techniques which employ an environmental gradient (e.g. temperature or salinity) to drive the living animals out of the sediment. A useful overview of meiofaunal sampling is provided by Higgins & Thiel (1988).

4.2.5. Rapid assessment survey approach

Emphasis on macrofauna is a useful approach when only limited collecting and sorting resources are available in the field. In addition, the taxonomy of macrofauna is relatively better known. In some groups most species can be readily identified in the field by an experienced collector, and this is regarded as a more environmentally friendly approach in conservation studies. Rapid visual survey techniques are useful as preliminary background information, and can provide fairly accurate species lists in taxa whose species are exposed and thus visible to divers (e.g. Roberts *et al.*, 2002).

4.2.6. Sediments sampling for quantitative assessment of diversity of skeletonized biota

Bioclastic sediment is composed of fragments of organic skeletal material. All marine sediments have a bioclastic component, and some, especially on oceanic reefs, are composed largely of this. In their study on the species richness of molluscs at a New Caledonian site, Bouchet *et al.* (2002) pointed out that among species encountered at only one station, 52% are represented only by empty shells. These species either live in a habitat that is difficult to sample, are exceedingly rare, or are seasonal/episodic. Rather than background noise to be discarded, skeletal remains of molluscs, brachiopods, forams, ostracods, and other skeletonized taxa can be used as an indicator of how much diversity is missed by the survey in taxa that lack *post mortem* remains, such as flatworms, polychaetes, meiofauna, peracarid crustaceans, etc. (Bouchet *et al.*, 2002). Sediment samples of 1-2 liters can provide a good estimate of the diversity of micromolluscs and other small skeletonized taxa of the area. A single such sample often contains well over 100 species of molluscs.

The following standardized sampling design can be used in reef systems. Select a site on the fore reef at 15-20 m depth in a sand patch at least a meter in diameter and within one meter of hard bottom. Secondary sites can be added to cover other habitat types as widely as feasible. Useful secondary sites could include samples from ca. 100 m on the reef talus (if dredges or grabs are available or from deepest scuba depth if not), protected or lagoonal sites at 10 m and 20 m, and shallow (<3 m) sites from moats, sand /mud flats, or reef flats, and samples from well-developed caverns/reef crevices or caves. For statistical comparisons of quantitative samples, 3-5 replicate sites of the same habitat type (e.g. 15-20 m fore reef) are useful, with sites within the same physiographic area, 10's of meters apart. Three 1+ liter samples for replicates are also useful per site. Exact volume is not important, and lesser volumes are better than none. In caverns often only limited sediment may be available, but these can be quite diverse. Record approximate distance among samples and the nature of the

bottom (size of sand patch, obvious macrophytes, etc). Each sediment sample should be gently washed in freshwater, so that the fine size fraction is not lost, then dried. In the case of excessively muddy sediments, it is useful to wash out the <0.5 mm size fraction to reduce sample bulk, but to preserve a 50-100 ml subsample for granulometric documentation. Label each collection on heavy, ideally waterproof stock (waterproof paper is ideal) with non-water soluble ink. Most sediment retains sufficient moisture after field drying to rapidly rot poor label material.

4.3. Sorting process

At the field lab, bulk samples and residues can be sieved in fresh seawater, and fractionated through a set of sieves from 10 to 0.5 mm, so that the coarse and fine fractions are separated (Fig. 5A). Obvious, and especially fragile, macrobiota (nudibranchs, polyclad flatworms, etc.) should be separated prior to sieving to minimize damage. The coarse fractions are sorted by eye, while fractions below 3 mm are sorted with the aid of dissecting microscopes (Fig. 5C-D). Picking of smaller fractions can be very time consuming, and if field time is more limiting than post-field lab time, then they can be preserved unsorted for later picking and study. A washing/sieving area should be located close to the field lab and a source of seawater assured.



Fig. 5. Field lab sample sorting. A. Fine sieving of bottom samples, Panglao 2004; B. Breaking rubble, Moorea Biocode 2008; C. Specimen sorting, Panglao 2008; D. Field lab for Panglao Biodiversity Project 2004. (Photos A, C & D by Panglao Marine Biodiversity Project 2004; B by Chris Meyer).

Samples collected in the field can be processed along two different routes. An important consideration for deciding which route to emphasize is the cost and availability of field vs. home lab time and desired data. Any specimen that has specific associated data (a photo, tissue sample, field observation) needs to be separated and tracked as a single specimen object. If photo documentation or genetic subsampling is a high priority in the survey, then as many specimens as possible should be so tracked.

Whenever possible it is useful to sort samples to morphospecies, because color and other useful field characters which allow for rapid species level sorting can fade or be lost upon preservation, making field sorting much more efficient for many taxa. The general workflow for processing a single fish collecting station is shown in Figure 6. After morphosorting, representative samples from the species were tissue subsampled (not shown), prepped, photographed and then tagged with unique identifiers. Efficient collecting yields many more specimens than can be processed at this level of detail while in the field, and remaining material can be bulk fixed, tagged only with a station number, and sorted back in the home lab.



Fig. 6. Fish sorting and workflow. A. Morphosorting a fish station sample; B. Preparation for photography; C. Photography; D. Tagging vouchers. (Photos by Chris Meyer).

Photography and Illustration

In situ or lab photographs of living or fresh animals capture distinct features and color patterns that are lost upon preservation. As such, live photos are important

for most marine taxa. Even for taxonomic groups where the appearance of live animals has not been used much for taxonomy (e.g. shelled molluscs – most books deal only with dead shells), living characteristics may reveal cryptic diversity or provide distinguishing features that differentiate closely related species whose dead remains are less descript. All digital photographs should have an unique identifier that connects them to the specimen photographed. A scientific illustrator may be a luxury, but is helpful for prized specimens, and camera-lucida drawings of selected live/fresh small individuals can be of great value for taxonomic work.

Genetic sampling

Molecular sequence data are becoming an increasingly important character set for delineating biological diversity. In 2003, researchers proposed that species could be identified by the sequence of just a single gene (Cytochrome Oxydase 1 or COI for animals), and that identification of animals and plants could be accelerated by these molecular characters (Hebert *et al.*, 2003). The capacity to identify all living organisms from a specific sequence of their genome is known as “DNA Barcoding” and is currently organized through CBOL (Consortium for the Barcode of Life: www.barcoding.si.edu) with membership from across the globe.

While controversy still exists as to the precision of this method (Meyer & Paulay, 2005), sampling biodiversity in the field would be remiss not to accommodate preserving at least a portion of the specimen for future genetic work.

The extensive fieldwork described above provides unique opportunities to create DNA collections from well vouchered collections for a vast array of tropical marine organisms (Fig. 7). Vouchers identified by taxonomic experts are essential for an effective DNA barcoding campaign. A major marine barcoding campaign (MARbol) is run through the University of Guelph (www.marinebarcoding.org), and readers are directed there for more information. Certain marine groups pose unique challenges for preservation. A special difficulty for snails is that for proper fixation, the animal must not be retracted deep inside the shell, especially if it closes with an operculum; yet, species-level taxonomy often requires examination of the intact shell. A combination of approaches should be used to ensure proper fixation and preservation of shell characters. This may be done by either breaking the shell of one specimen and conserving it side by side with an intact specimen of the same species from the same sample; or by relaxing an extended animal in extension with magnesium chloride; or by carefully extracting the snail out of its shell with a bent needle, or through niku-nuki (Fukuda *et al.*, 2008), a method that uses flash boiling to remove the animal. For crustaceans, the problems are less but still require that interesting species be specially preserved in alcohol. Freezing or relaxation prior to preservation is advised to prevent autotomization of appendages.



Fig. 7. Tissue subsampling for molecular work. A. Sorted micromollusks relaxing prior to tissue sampling; B. Tissue subsampling straight into digestion buffer for DNA extraction onsite, Morrea Biocode 2008; C. Barcoding Alley, tissue subsampling, Santo 2006; D. Echinoderm subsamples in 2D barcoded tubes. (Photo A by Chris Meyer; B by John Deck; C by Yuri Kantor and D by John Starmer).

Fixations for anatomical work

In parallel, further specimens should be relaxed and fixed for anatomical or microscopical work in appropriate fixatives (glutaraldehyde for electron microscopy; Bouin's solution, formalin or alcohol for dissecting) (see Appendix I for description of preservation methods and Appendix II for procedures by taxon). For macrobiota the same specimen should be prepared for both genetic and morphological analysis, with a tissue subsample for DNA taken from the organism prior to anatomical fixation.

Sorting after fieldwork

Samples from individual stations can be sorted to morphospecies and identified generally to the family level in the field (Fig. 6C). Bulk samples are sorted back in the home lab/museum to morphospecies or to the finest level possible. The lowest sortable level should be at least to a taxonomic rank that corresponds to the typical expertise of taxonomists. Specimens are then identified to the lowest taxonomic level readily doable (usually family to species), depending on available expertise. The taxonomic limits of field-based morphospecies designations should be verified by a network of taxonomists and/or by DNA analyses. After segregation to morphospecies/taxa gross measures of abundance (number of

specimens per taxon per station) can be captured if quantitative estimates are desired and the sample appropriate. The resulting information is stored in a relational database. Because of the combined qualitative and semi-quantitative methods employed in marine ATBIs, statistical analyses based on relative abundance data can only be constructed from bulk samples processed to the specimen level. Thus, projections of total species richness at the study site are accordingly difficult.

4.4. Data Management

The utility of specimens generated from a biotic survey is only as good as the associated data included with the collection. As such, information concerning the collecting event and specimen(s) should be managed with utmost care. The volume of material generated during a large-scale inventory can quickly become overwhelming if a consistent data management scheme is not in place. Field data includes the two major categories: event data (where and when) and specimen data (what). Each of these data types should be associated with a table of particular, standardized fields to make data portability and accessibility as easy as possible. In general, these data conform to standards adopted by GBIF and OBIS. In general there is usually a one-to-many relationship between events and specimens as many individuals are collected during a single event (dredge, dive, etc.). Event data should include primary location (*e.g.* island), secondary location (specific site on island), coordinates, habitat type, sampling method, depth, date, and collector. On reef systems, major habitat types to be tracked include: outer reef slope/fore reef, reef crest, outer reef flat, inner reef flat, inner sand flat, mangrove, moat (<3 m deep), lagoon (>3 m deep), lagoon slope, lagoonal patch reef, etc. Specimen data should include identity of taxon to lowest level known, microhabitat, any associated specimens and association type (symbiotic, etc.), fixative and preservative used, whether photographed and subsampled for genetics, and specific notes about sample and specimens. Microhabitats include whether animal lived in sand, attached under rock, loose under rock, in reef framework, boring in rock, commensal associations, etc. Specific notes should include particular aspects about individual specimens where this is important (color in life, texture, smell, etc. – these are often taxon specific, see Appendix II). Other notes about taxa may include abundance or specific behaviors. Large-scale ATBIs should enter this information in spreadsheet form and a database manager should compile each day's activities into a single database. An example template for such field expeditions can be found at http://biocode.berkeley.edu/batch_upload.html.

In addition to station/sample data, one should consider keeping more general field notes. There is a compromise between sampling and taking field notes in terms of effort in any field situation. As time allows, notes about the habitat are useful, both for recording the environment in association with the samples collected and for describing for future workers the environment so that they are able to recognize changes over time. Field notes can cover gross site description (exact location, site map, nature of site in terms of bottom type, topography, benthic cover, dominant species in community, etc.), notes about what you focused on (so future workers can judge what you would have likely recorded if it

was there), and notes about the taxa/communities studied. For the latter a list of species with relative abundances can be useful – but only as useful as identification skills and photo/specimen vouchering allow. Haphazard notes about taxa not focused on are less useful, unless the particular species noted is unusual in its occurrence. If time is limiting, field notes can be captured on voice recorder, and saved as a voice file with the station data. Much of this information can be captured in the database and associated with the collecting event.

Labels and notes

An average day in the field with a large group of participants yields numerous collecting events and hundreds to thousands of specimens. With such a large number of samples and specimens, together with associated photographs and documentation, accurate labelling is critical. It is recommended that a principal field coordinator keeps a master list of all collecting stations/events. Unique event identifiers should be posted centrally at the field lab so that all participants can see and use them. Multiple labels with the collecting station number can be pre-written and then placed within each of the samples and subsamples as bulk samples get split and sorted to various taxonomic levels. A specimen number series can be pre-designated for taxonomic teams or working groups so that labels can also be pre-written and assigned as the material is fractionated along the processing pipeline down to morphospecies lots or individual specimens, when tissue samples or photographs are taken. These labels should be made with sufficient room on the card stock to allow addition of information about the sample (e.g. taxon name, color, sex, notes); such extra labelling also provides excellent error checking in cases of confusion. Data can be entered directly into spreadsheets or onto pre-printed sheets, with just the basic minimum fields (EventID, specimenID, lowest taxon, PhotoID(s), tissueID, notes). Care should be taken to be sure to log these data every day into the database, so as not to get too far ahead and lose track of pertinent information and details. Backups, preferably offsite, of the central database should be made each day to insure against disk failure. All paper records and notebooks should be archived (digital images of these are useful) as well as any maps with marked stations. All field labels should be on appropriate sturdy, archival paper stock with pencil or permanent ink that can withstand various media. Make sure field labels are sufficiently large relative to the sample so that they do not get easily lost or overlooked.

5. Acknowledgements

We are grateful to Philippe Bouchet who permitted us to use all reports, information and documentation (including photographs) coming from the Panglao-2004 Marine Biodiversity Project and Santo-2006 Global Biodiversity Survey. We thank to the members of EDIT WP7 for inviting us to participate in this manual. Support from NSF (DEB 0529724) and the Moore Foundation (Moorea Biocode Project) are gratefully acknowledged.

6. Recommended references

- ANGEL, M.V. 1993. Biodiversity of the pelagic ocean. *Conservation Biology* 7: 760-771.
- BOUCHET, P. 2006. The magnitude of marine biodiversity. In: C.M. DUARTE (Ed.). *The exploration of marine biodiversity, Scientific and technological challenges*. Fundación BBVA, Bilbao, Spain: 31-64.
- BOUCHET, P., LOZOUET, P., MAESTRATI, P. & HEROS, V. 2002. Assessing the magnitude of species richness in tropical marine environments: exceptionally high numbers of molluscs at a New Caledonia site. *Biological Journal of the Linnean Society* 75: 421-436.
- BOUCHET, P., NG, P.K.L., LARGO, D. & TAN, S.H. 2009. PANGLAO 2004 - Investigations of the marine species richness in the Philippines. *Raffles Bulletin of Zoology*, Supplement 20: 1-19.
- CHAPMAN, A.D. 2009. *Numbers of living species in Australia and the World*. Australian Biological Resources (ABRS), Canberra: 84 pp.
- CHAVE, A. 2004. Seeding the seafloor with observatories. *Oceanus* 42: 28-31.
- CLARKE, T. 2003. Oceanography: robots in the deep. *Nature* 421: 468-470.
- COSTELLO, M.J., BOUCHET, P., EMBLOW, C.S. & LEGAKIS, A. 2006. European marine biodiversity inventory and taxonomic resources: state of the art and gaps in knowledge. *Marine Ecology Progress Series* 316: 257-268.
- DENNIS, C. & ALDHOUS, P. 2004. A tragedy with many players. *Nature* 430: 396-398.
- DIVAS, C.L. 2004. Close encounters of the deep-sea kind. *BioScience* 54: 888-891.
- GABRIEL, O., LANGE, K., DAHM, E. & WENDT, T. 2007. *Fish catching methods of the World (Fourth edition)*. Blackwell Publishing Ltd, London: 523 pp.
- GAGE, J.D. & TYLER, P.A. 1991. *Deep-sea biology. A natural history of organisms at the deep-sea floor*. Cambridge University Press, Cambridge: 504 pp.
- GARLAND, E.D. & BUTMAN, C.A. 1996. Measuring diversity of planktonic larvae. *Oceanus* 39: 12.
- GOSWAMI, S.C. 2004. *Zooplankton methodology, collection & identification – a field manual*. National Institute of Oceanography, Goa: 16 pp.
- GRASSLE J. & MACIOLEK N.J. 1992. Deep-sea species richness: regional and local diversity estimates from quantitative bottom samples. *American Naturalist* 139: 313-341.
- GRAY, J.S. 1997. Marine biodiversity: patterns, threats and conservation needs. *Biodiversity and Conservation* 6: 153-175.
- GROOMBRIDGE, B. & JENKINS, M.D. 2002. *World Atlas of Biodiversity*. Prepared by the UNEP World Conservation Centre. University of California Press, Berkeley,

USA: 340 pp.

FUKUDA, H., HAGA, T. & TATARA, Y. 2008. Niku-nuki: a useful method for anatomical and DNA studies on shell-bearing molluscs. *Zoosymposia* 1: 15-38.

HARRIS, R.P., WIEBE, P.H., LANZ, J., SKJOLDAL, H.R. & HUNTLEY, M. 2000 (Eds). *Zooplankton methodology manual*. Academic Press, London: 684 pp.

HEBERT, P.D.N., CYWINSKA, A., BALL, S.L. & DEWAARD, J.R. 2003. Biological identifications through DNA barcodes. *Proceedings of the Royal Society B: Biological Sciences* 270: 313-321.

HEIRTZLER, J.R. & GRASSLE, J.F. 1976. Deep-sea research by manned submersibles. *Science* 194: 294-299.

HENDRIKS, I.E., DUARTE, C.M. & HEIP, C.H.R. 2006. Biodiversity research still grounded. *Science* 312: 1715.

HIGGINS, R.P. & THIEL, H. 1988. *Introduction to the study of meiofauna*. Smithsonian Institution Press, Washington, DC.: 488 pp.

HOEKSEMA, B.W. 2007. Delineation of the Indo-Malay centre of maximum marine biodiversity: the coral triangle. In: RENEMA, W. (Ed.), *Biogeography, Time and Place: distributions, barriers and islands*. Springer, Dordrecht: 117-178.

HOLME, N.A. & MCINTYRE, A.D. (Eds) 1984. *Methods for the study of marine benthos* (Second Edition). Blackwell Scientific Publications, London: 387 pp.

KINGSFORD, M. & BATTERSHILL, C. 1998. *Studying temperate marine environments. A handbook for ecologists*. Canterbury University Press, New Zealand: 335 pp.

LAMBSHEAD, P.J. 1993. Recent developments in marine benthic biodiversity research. *Oceanis* 19: 5-24.

MENDOZA, J.C.E., NARUSE, T., TAN, S.H., CHAN, T.-Y., RICHER DE FORGES, R. & NG, P.K.L. in press. Case studies on decapod crustaceans from the Philippine reveal deep, steep underwater slopes as prime habitats for 'rare' species. *Biological Conservation*.

MEYER, C.P. & PAULAY, G. 2005. DNA barcoding: error rates based on comprehensive sampling. *PLoS Biology* 3: e422.

MORIN, P.J. & FOX, W. 2004. Diversity in the deep blue sea. *Nature* 429: 813-814.

NG, P.K.L., MENDOZA, J.C.E. & MANUEL-SANTOS, M. 2009. Tangle net fishing, an indigenous method used in Balicasag Island, central Philippines. *Raffles Bulletin of Zoology*, Supplement 20: 39-46.

O'DOR, R. & GALLARDO, V.A. 2005. How to census marine life: ocean realm field projects. *Scientia Marina* 69 (suppl. 1): 181-199.

PAULAY, G. & MEYER, C. 2002. Diversification in the tropical Pacific: Comparison between marine and terrestrial systems and the importance of founder speciation. *Integrative and Comparative Biology* 42: 922-934.

PLAISANCE, L., KNOWLTON, N., PAULAY, G. & MEYER, C. in press. Reef-associated crustacean fauna: Biodiversity estimates using semi-quantitative sampling and DNA barcoding. *Coral Reefs*.

REAKA-KUDLA, M.L. 1997. The global biodiversity of coral reefs: a comparison with rain forests. *In: REAKA-KUDLA, M.L., WILSON, D.E. & WILSON, E.O. (Eds). Biodiversity II: understanding and protecting our biological resources*. Joseph Henry Press, Washington: 83-108.

RICHER DE FORGES, R., TAN, S.H., BOUCHET, P., NG, P.K.L., CHAN, T.-Y. & SAGUIL, N. 2009. PANGLAO 2005 - Survey of the deep-water benthic fauna of Bohol Sea and adjacent waters. *Raffles Bulletin of Zoology*, Supplement 20: 21-38.

ROBERTS, C.M., McCLEAN, C.J., VERON, J.E.N., HAWKINS, J.P., ALLEN, G.R., McALLISTER, D.E., MITTERMEIER, C.G., SCHUELER, F.W., SPALSING, M., WELLS, F., VYNE, C. & WERNER, T.B. 2002. Marine biodiversity hotspots and conservation priorities for tropical reefs. *Science* 295: 1280-1284.

ROPER, C.F.E. & RATHJEN, W.F. 1991. World-wide squid fisheries: a summary of landings and capture techniques. *Journal of Cephalopod Biology* 2: 51-63.

ROPER, C.F.E. & SWEENEY, M.J. 1983. Techniques of fixation, preservation, and curation of cephalopods. *Memoirs of the National Museum of Victoria* 44: 28-47.

SIBERT, J.R. & NIELSEN, J.L. (Eds) 2001. *Electronic Tagging and Tracking in Marine Fisheries. Reviews: Methods and Technologies in Fish Biology and Fisheries*. Kluwer Academic Publishers, Dordrecht: 468 pp.

SPALDING, M., TAYLOR, M., RAVILIOUS, C., SHORT, F.T. & GREEN, E.P. 2003. Global overview. The distribution and status of seagrasses. *In: SHORT, F.T. & GREEN, E.P. (Eds). World atlas of seagrasses*. University of California Press, Berkeley: 5-26.

SUTHERS, I.M. & RISSIK, D. 2009 (Eds) *Plankton. A guide to their ecology and monitoring for water quality*. CSIRO Publishing, Sydney: 232 pp.

UNESCO, 1968. *Monographs on oceanographic methodology: Zooplankton sampling*. Vol. 2. UNESCO, Paris: 174 pp.

VENTER, J.C., REMINGTON, K., HEIDELBERG, J.F., HALPERN, A.L., RUSCH, D., EISEN, J.A., WU, D., PAULSEN, I., NELSON, K.E., NELSON, W., FOUTS, D.E., LEVY, S., KNAP, A.H., LOMAS, M.W., NEALSON, K., WHITE, O., PETERSON, J. HOFFMAN, J., PARSONS, R., BADEN-TILLSON, H., PFANNKOCH, C., ROGERS, Y.-H. & SMITH, H.O. 2004. Environmental Genome Shotgun Sequencing of the Sargasso Sea. *Science*, 304: 66-74.

VEZZULLI, L., DOWNLND, P.S., REID, P.C., CLARKE, N. & PAPADAKI, M. 2005. *Gridded database browser of North Sea Plankton: fifty years (1948-1997) of monthly plankton abundance from the Continuous Plankton Recorder (COR) survey*. Sir Alister Hardy Faoundation, Plymouth, UK (available in CDROM).

WENNECK, T. DE L., FALKENHAUG, T. & BERGSTAD, O.A. 2008. Strategies, methods, and technologies adopted on the R.V. *G.O. Sars* MAR-ECO expedition to the Mid-Atlantic Ridge in 2004. *Deep-Sea Research* 55: 6-28.

YARINCIK, K. & O'DOR, R. 2005. The Census of Marine Life: goals, scope and strategy. *Scientia Marina*, 69 (suppl. 1): 201-208.

7. Appendix I. Preservational aspects

7.1. Relaxation

Purpose is to anaesthetize a specimen so it is unable to respond or contract when placed in fixative. Important for humanitarian reasons, as well as because in many groups identification is hampered or made impossible if fixed in a contracted form; in other groups (e.g. crustaceans, some echinoderms) autotomy may occur if dropped straight into fixative. When relaxing make sure the animal: (1) expands if it started out contracted (ascidians, anthozoans) (this may not always happen) and (2) is fully relaxed and does not respond to even strong poking. Do not poke strongly until you are sure it is fairly unresponsive, as otherwise an initial poke will send specimen into real contraction from which it may not come back out. Relaxants are often group specific; some useful chemicals are listed below (there are many others). You may need to experiment with various methods before you find one that works for a specific taxon. Even closely related groups may relax better with different relaxants.

MgCl₂: prepared in freshwater at 7.5% weight — which is isoosmotic with seawater. Note that MgCl₂ crystals are highly hydrophilic, so if they have been stored poorly and absorbed water, you will need to mix a generously greater amount. Exact percentage is not critical. MgCl₂ works by competing with Ca in muscles and nerves, making animals unable to contract. MgCl₂ works well with most marine organisms, but can take an hour or more for larger animals. A 50:50 mixture of isotonic MgCl₂ solution: sea water is a good general mix to use; MgCl₂ solution should be gradually added to seawater for especially sensitive animals.

Menthol: add to dish with animals by either sprinkling crushed crystals on top or adding drops of concentrated menthol solution prepared in ethanol. Menthol works especially well for cnidarians and ascidians.

Chloretone = chlorobutanol: Chloretone is not readily miscible in water, so it is prepared in a saturated ethanol solution (a large amount of the chloretone can be dissolved in a volume of alcohol). A couple of drops in a bowl or a pipette full to a bucket works well on echinoderms, including large holothurians.

Clove oil = eugenol: knocks out most crustaceans rapidly. Prepare a saturated solution in sea water, and add to bowl containing animals. Can glom up finely setose appendages of small crustaceans if used straight. A 25% solution of clove oil in ethanol is a useful field anaesthetic and will flush and stun cryptic crustaceans such as stomatopods from crevices.

Cooling/freezing: cooling can facilitate (and enhance chemical-based) relaxation in warm water organisms. Freezing is an effective and humane way of killing animals that can be photographed or subsampled in a freshly thawed state, especially useful for strongly skeletonised crustaceans, like crabs, and shelled molluscs. Slow freezing (but not cooling) can be bad for anatomy and histology so DO NOT use it for soft bodied groups where anatomical information is desired.

Propylene phenoxitol: A nowadays difficult to get but excellent relaxant for bivalves and some other invertebrates. A couple of drops added to a bowl go slowly into solution and rapidly knock out animals.

7.2. Fixation

The purpose of fixation is to fix tissues for long term storage and study. Formalin or similar strong fixatives (Bouin's fixative, glutaraldehyde, etc.) are necessary for histological quality fixation and for most groups where detailed anatomy or histology is needed for identification (e.g., ascidians, most worms, cephalopods, opisthobranchs, etc.). Formalin makes tissue difficult to use or unsuitable for DNA sequencing however. Ethanol is fine as a fixative for groups where only external characters or gross anatomical features are used in taxonomy (e.g., most crustaceans and sponges), and is more pleasant and less hazardous to work with. It is also preferred for groups (like holothurians) where the greater potential acidity introduced by formalin may etch or destroy tiny calcareous sclerites used in taxonomy. An ethanol solution of 70-80% is ideal for fixation, because the alcohol penetrates more readily and does not cause too much tissue shrinking. Lower concentrations may not prevent all microbial activities, while higher concentrations can greatly shrink specimen and make specimens (especially crustacean legs) brittle. It is very useful to take a small (1-3 mm) tissue sample from larger animals and fix it in ample (>10x tissue volume) as a genetic subsample, as it will yield better quality DNA than bulk-fixed samples. Preferably change the alcohol in the field a day or two after initial fixation. Taking a tissue subsample is essential for formalin-fixed specimens if future genetic study is considered.

When fixing large animal (such as large sponges or sea cucumbers) in ethanol, it can be useful to initially fix in 95% ethanol to balance the water content of the animal – you can eyeball this volumetrically. You should always use plenty of fixative fluid – at least 3x volume of specimen, to make sure that the final concentration of fixative is adequately high to do the job (70% for ethanol, 5-10% for formalin). If you are fixing larger animals (> 2-4 cm in all dimensions) it is important to make sure that the fixative penetrates. This is best achieved by injection with a hypodermic needle into the body cavity or body, or by cutting the animal open. Be careful not to blow up the animal or unduly destroy anatomy when doing this. Some fixatives, like Bouin's, have chemical agents to facilitate tissue penetration. Changing the alcohol after a couple of days also improves preservation.

Formalin is used generally at 5-10% strength of the industrial "formalin" mixture – which itself is ca. 38% formaldehyde gas dissolved in water. Thus 10% "formalin" is 3.8% formaldehyde. For marine animals, formalin should be mixed with sea water to make it isoosmotic; for freshwater animals it is mixed with freshwater. At least for taxa with calcareous parts (but is good practice for any taxa) formalin needs to be buffered, as it turns acidic (forming formic acid) with age. Buffering can be achieved with laundry borax (sodium borate), or in a pinch by adding calcium carbonate powder/sand. For good histological/anatomical fixation you may want to use buffer recipes, or use special fixatives like Bouin's.

Bulk alcohol usually comes at 95% concentration; absolute (100%) ethanol is considerably more expensive. 70-80% ethanol is used for routine fixation. 95-100% ethanol is often used for genetic fixation of small subsamples, but whether subsamples are better fixed at this high or at 70-80% ethanol concentrations has come into question. Mix ethanol with distilled (deionized, or otherwise fairly soft) water, as precipitates can form with hard water. In field situations pure ethyl alcohol can be difficult to obtain, but denatured spirits (~95% ethanol + methanol + odor and sometimes color) are available in most places and provide a good alternative. For genetic fixation remove excess water from the specimen as much as possible, add ethanol equal to 5-10x the tissue (not counting shell) volume of the sample, and change at least once in the field, and again back in the lab

7.3. Preservation

Once a specimen is fixed (takes a day or so for small (<1 cm) animals to a week for big ones, then the animal can be transferred into a different, and more benign medium for long term preservation. Thus formalin fixed samples are often transferred to alcohol. To do this, the formalin needs to be soaked out by letting the specimen sit in water (or seawater) for couple of hours to days, then transferred to alcohol. Initial alcohol fix should also be replaced with fresh alcohol after a couple of days, to bring ethanol concentration closer to target and remove debris and solutes from the jar (although retaining solutes in original alcohol may be desired if chemical study of secondary metabolites is desired). For final voucher storage, specimens should be in the smallest jar/vial they fit comfortably into without, and filled to the top with the preservative. Filling the container is important because: 1) more preservative takes longer to evaporate, thus giving more time to discover a faulty seal, and 2) this sets a standard, so that evaporation can be immediately noticed in a collection and addressed by replacing lid or jar. The amount of alcohol relative to specimen volume is no longer important at this stage.

8. Appendix II. Procedures by taxon

Procedures are given here for some of the macrofauna most commonly targeted in surveys. This overview is not meant to be exhaustive for either taxa or methods.

Porifera: No relaxation needed, fix in ample volume of 70-95% alcohol depending on size, transfer to clean alcohol in a days-week. In addition to basic field data, record color (external and internal, if possible), texture, surface feel, odor, mucus production, and any other obvious live character of the sponge. *In situ* photos are very useful for sponges and should be linked to the voucher specimen.

Hard corals: as most characters are based on the skeleton, corals are usually bleached with a solution of sodium hypochlorite to remove all tissues, then washed and dried. However a scraping or small piece of the colony should be preserved in ethanol or one of the specialized coral DNA fixative cocktails to provide a genetic subsample. *In situ* photos are very useful and should cover colony shape as well as a close up of undisturbed polyps.

Soft corals: are not usually relaxed, and can be fixed in alcohol or buffered formalin (former often preferred for taxonomy to minimize etching of ossicles, latter preferred if histological fixation is desired) and stored in alcohol. *In situ* photos are very useful.

Gorgonians (sea fans): are fixed in alcohol or fixed in buffered formalin then quickly dried. If colony is dried, it is useful to have a small portion fixed and stored in alcohol. *In situ* photos are useful.

Black corals: should be fixed like gorgonians, with a good portion pickled. Ethanol is an adequate fixative, formalin is required for histology only. Color notes and *in situ* photos, especially of the expanded polyps are very useful for taxonomy.

Anemones: should be relaxed well with menthol, fixed in formalin ideally when expanded, and stored in alcohol. Photo of live animal is very useful.

Flatworms: Large turbellarians can be challenging to fix because they are fragile, readily contract and can disintegrate. Good fixation can be achieved by allowing animal to crawl and expand on a piece of moistened paper, then placing the paper and animal gently onto frozen formalin to fix; preserve in ethanol. Taking a snippet of tissue with a razor from the end of the crawling worm provides a subsample for DNA and can be fixed in ethanol. Photos of living animal are essential for colourful species.

Other worms: Relax with $MgCl_2$ generally, fix in formalin, preserve in EtOH. Taking tissue subsamples or fixing duplicate animals in ethanol is needed for DNA work. Fixing long nemertean worms straight is important to facilitate sectioning. Photos are useful for colourful species.

Crustaceans: Larger, tough specimens are easiest to kill by freezing, smaller ones relax well with clove oil. Fixation and preservation in alcohol is ideal. Photos of colourful species are very useful. Crabs are best photographed freshly killed with legs spread; for shrimp and other translucent species living photos are much better.

Mollusks: While shells from dead (or live) species can be sufficient for identification, live specimens should be fixed in fluid when possible. $MgCl_2$ and propylene phenoxitol are good relaxants for many molluscs. Fixation can be in alcohol or formalin, with the latter much preferred/essential for opisthobranchs and cephalopods. Photos are most useful for opisthobranchs and cephalopods, but also for soft body of any species.

Bryozoans: Like hard corals, bryozoan taxonomy relies on the skeleton, so dried specimens are fine for taxonomic study, but alcohol-fixed or subsampled animals are best for genetics. Photos are the best way to record colony shape, especially in fragile species.

Ophiuroids, asteroids, echinoids: Best relaxed with $MgCl_2$ in a flat pan for stars so they spread out, then fixed in ethanol or formalin. Ethanol fixation is preferred if specimens will be kept wet, while formalin provides better fix for specimens destined to be dried out. As most/all taxonomic characters are skeletal, dried specimens are a good way to keep especially large specimens. Associated field photos and genetic ethanol biopsies important. Tube feet make easily accessible subsamples in echinoderms.

Crinoids: Best fixed by pushing animal oral surface down into a pan of ethanol, allowing the arms to spread while pushing the animal into the alcohol. This way they die in seconds and fix in a spread-out position. Preserve in alcohol. Field photos are useful.

Holothuroids: Relax with $MgCl_2$ or chloretone, inject with and fix in 70-95% EtOH depending on size (to dilute down to 70-80% with body fluids); preserve in EtOH. Field/live photos extremely useful.

Urochordates: Relax with menthol, fix in formalin, store in formalin. Ideally *in situ* photo is extremely useful. Tissue subsamples for genetic studies should be preserved in alcohol.

Chapter 12

Collecting the neglected kingdom: Guidelines for the field mycologist with emphasis on the larger fungi

by

Bart Buyck

Muséum National d'Histoire naturelle, Dept. Systematics and Evolution
57 rue Cuvier, F-75231 Paris, France
Email: buyck@mnhn.fr

Thomas Læssøe

University of Copenhagen, Department of Biology
Universitetsparken 15, Copenhagen 2100 Ø, Denmark
Email: thomasl@bio.ku.dk

Marianne Meyer

Le Bayet, F-73730 Rognaix, France
Email: marianne.meyer2@wanadoo.fr

Valerie Hofstetter

Station de recherche Agroscope Changins-Wädenswil
Dépt. Protection des plantes, Mycologie
CH-1260 Nyon 1, Switzerland
Email: valerie.hofstetter@acw.admin.ch

Abstract

Guidelines are provided for collecting a group of organisms that has often been overlooked in earlier inventories: the kingdom Fungi and other groups that are traditionally collected by mycologists such as slime molds. After a short introduction on fungi and the feasibility of an 'all fungal taxa' inventory, the authors divide the fungi in six 'practical' groups that require specific approaches: slime molds, lichens, parasitic fungi of plants and animals, larger mushrooms, microscopic fungi. Various topics are discussed in relation to three chronological stages (before, during and after the collecting trip) and include various aspects such as equipment, photography, barcoding, documenting, storing collections, macrochemical reactions, preparation of spore deposits, humid chamber technique, ... At the end of the paper the reader will find a selection of various important web references for the field mycologist interested in various fungal groups and their taxonomic aspects.

Key words: ATBI, slime molds, ascomycetes, basidiomycetes, lichens, inventory

1. Introduction: the neglected kingdom

Mushrooms are often looked upon as some kind of odd vegetable but thanks to recent technological progress it has now been firmly established that mushrooms belong to a very diverse group of organisms we call 'fungi'. Fungi are neither plants nor animals, but represent a separate kingdom of living organisms: the 'fungal kingdom' or the 'mycota'. Because they share several biochemical and cytological features with the animal kingdom fungi are more closely related to animals than to plants (e.g. their cell walls contains chitin – a compound that also occurs in animals but not in plants, animals and fungi store their energy as 'glycogen', not in the form of 'amylum' as plants do, animals and fungi are both heterotrophic groups unlike plants which are autotrophic, ...).

Although mycology has traditionally been taught as part of a botany course, fungi are studied by mycologists, not by botanists. Unfortunately, professional mycologists that are focusing on systematics and taxonomy of fungi are very few and their number is still declining (e.g. Buyck, 1999). As a result, we still know very little about the fungal diversity on this planet. Mycologists only recently realised that less than 5% of an estimated minimum of 1.5 million fungal species that inhabit this planet have been officially described (Hawksworth, 2001) and this not only concerns many microscopical or cryptic groups with simple morphologies, but also many, often even common or traditionally consumed, larger mushrooms.

The fact that we still know so little about the fungi has of course important consequences when talking about an "all taxa biodiversity inventory". The negative aspects of our general ignorance about fungi can be easily understood when being confronted with the almost complete absence of comprehensive or easily accessible identification literature for fungi in most parts of the world, as well as with the countless name changes for fungal species due to the existing confusion over classification issues (especially due to the recent repercussions of molecular evidence). One positive aspect of the recent interest in fungi, however, is that governmental and environmental decision-makers are becoming more and more aware of the important role fungi are playing for the conservation and the survival of all kinds of habitats and for that of nearly all other groups of organisms. Whereas past inventories focused principally on plant and animal biodiversity, we finally witness a growing awareness that the fungal component needs to be included as well.

2. How realistic is an 'all fungal taxa' inventory?

On top of our general ignorance concerning the amplitude of fungal diversity, mycologists are also confronted with other problems. One of the major problems for an inventory is the fact that most groups of fungi (the few exceptions include lichenized fungi for example) are not the easiest organisms to collect and to study. Indeed, many groups – particularly the larger fungi – are invisible during most of their life remaining completely hidden inside a substrate (whether this is inside living host tissue, in soil or in dead wood or even inside other fungi). When

making inventories, mycologists are usually limited to those groups that are visible above ground. For most of the larger ascomycetes and basidiomycetes this is at the moment they reproduce sexually. However, the irregularity of appearance of these sexually reproductive structures (called 'mushrooms') and the strong dependence of the latter on sufficient precipitation can make it extremely difficult to realize a good inventory (see caption below).

Above-ground visible diversity is very different from the 'actual' below-ground or host-related diversity as e.g. shown by a study in a Swiss forest (Straatsma *et al.*, 2001): species richness, abundance and phenology of fungal fruit bodies over 21 years in a Swiss forest plot.

Permanent plots of 1500 m² in Swiss spruce forest:

- 21 successive years give a total of 408 species of larger fungi;
- from 18 to 194 different species recovered per year;
- only 8 species (2%) fruited constantly every year;
- still 19 (5%) previously undiscovered species were found in the last year.

A second problem with inventories is usually manpower. As professional mycologists capable of identifying fungi are very few and mostly swamped by other obligations, it is in our opinion absolutely imperative to involve also the members of mycological and lichenological societies that exist in many countries. Especially for the larger fungi and for some of the other groups such as slime molds or lichenized fungi, these societies can supply the necessary expertise but may often need some guidance on particular technical or methodological requirements of a scientific approach (links to most of the important mycological societies in the world can be found at the European Mycological Association website: <http://www.euromould.org>).

3. What groups of organisms are composing the Fungi? ... and are they all equally suitable for an ATBI?

The most recent proposal for a scientifically sound classification of the Fungi was published by Hibbett *et al.* (2007). However, in the context of an ATBI, it is more appropriate to consider practical groups that require more or less similar approaches in the field. The groups mentioned below therefore do not correspond to some actual classification of the Fungi; they represent the most common practical approaches for Fungi in mycological inventories.

3.1. Slime molds or 'myxomycetes'

Myxomycetes are no longer considered to be part of the Fungal kingdom and are now classified among the protists. Nevertheless, they correspond to a group of organisms that has traditionally been studied by mycologists. The expertise on this group remains therefore with some rare professional mycologists but is especially passed on within the various mycological societies.

The number of species is relatively low (ca 1500 worldwide). Slime molds form a natural group within Kingdom Protista and inventories mostly concern the true myxomycetes (Eumycetozoa). These myxomycetes can be considered an 'easy' group in inventories because:

- Collecting is easy once you know what to look for, but a hand lens (10x-20x) is absolutely necessary. In the absence of fruitbodies, one can collect substrates that are later kept under humid conditions to favor development (this technique is especially valuable for recovering very tiny or rare species). For more details see 'humid chamber technique' below.
- Literature resources / identification guides are very good on a world scale.
- Description requirements in the field are not or very rarely required.
- Preservation is very easy (simply air drying).
- Identification requires nevertheless a good microscope.
- There are plenty of web resources.

3.2. Lichenized fungi or 'lichens'

Lichens are dual, mutualistic, symbiotic organisms: a lichen thallus consists mainly of a fungus (generally an ascomycete, rarely a basidiomycete or a zygomycete) that harbors a species of green algae and/or cyanobacterium inside its tissue. There are also several groups of fungi that parasitize lichens or simply live inside a lichen benefiting from the moisture and protection of the host thallus! The number of species is high (ca 20,000 worldwide).

Lichens are not an easy group, especially in the southern hemisphere, although:

- Collecting is easy, at least for foliose or fruticose species (very analogous to collecting bryophytes – see chapter 13) but may be more problematic in the case of crustose species that are adhering firmly to the surface of rocks, stones and bark of living trees.
- Literature resources / identification guides are plenty for the northern hemisphere, but are limited or lacking elsewhere.
- Correct identification needs microscopic observation and often requires the use of certain chemicals and chromatography, but many species in the southern hemisphere remain to be described.
- Description requirements in the field are minimal.
- Preservation is easy (specimens are simply air dried).
- Web sources are good for the northern hemisphere.

3.3. Mushrooms and toadstools (the 'larger fungi')

The number of species is very high (some hundreds of thousands worldwide), mainly the larger ascomycetes and basidiomycetes. The larger fungi or

'macrofungi' are generally of special interest to mycological societies which usually possess both the expertise and bibliographic resources. Nevertheless, the larger fungi are difficult to study.

- Collecting is relatively easy in most cases, but the material is usually useless without a detailed description and pictures of the fresh fruitbodies, notes on spore deposits, chemical reactions, etc.
- Literature resources and identification guides are good to very good for Western Europe, Scandinavia and the Mediterranean area, but become very problematic elsewhere, even for rich western countries such as the USA where a very high proportion of the taxa remains to be described.
- Identification is difficult because of the wide array of simple to complex characters that need correct interpretation. Most often students require good microscopic skills, long standing experience, use of various chemicals and specialized literature in different languages. The complete absence of identification guides in most parts of the world is a further major obstacle.
- Preservation implies rapid drying using a desiccator.
- Web resources are limited although specialized web sites exist for many individual genera or families.

3.4. Plant parasitic fungi

The number of species is very high (several hundreds of thousands worldwide) and most species belong to specialized groups of ascomycetes (*e.g.* powdery mildews) and basidiomycetes (*e.g.* rusts and smuts) and also to several other groups of fungi (zygomycetes, chytridiomycetes) and the fungal-like oomycetes that are typically studied in the laboratory by phytopathologists (although such fungi fall mostly under 3.6 below). Depending on the group:

- Collecting is easy in most cases (similar to collecting plants – see chapter 14).
- Description requirements on fresh material are minimal.
- Literature resources can be quite good.
- Identification guides are restricted to specialized literature. Identification itself requires good botanical knowledge (you need to identify the host plant), and is impossible without the observation of microscopic features. For some of the purely microscopical groups (chytridiomycetes etc.) identification usually requires culturing on artificial media.
- Preservation is easy since specimens are dried as part of a botanical specimen.
- Web resources exist for some groups.

3.5. Animal parasites above microscopic level (Hypocreales such as e.g. *Cordyceps*, Laboulbeniomyces, ...)

The number of species is high (especially if considering Laboulbeniomyces) and the experts or mycologists capable of identifying these groups are very limited. These groups are therefore too specialized to be covered in most ATBI's.

- Collecting is similar to collecting the animal host (insects and their larvae normally, spiders, ...).
- Description requirements *in situ* are minimal for such tiny organisms as Laboulbeniomyces but their observation and preparation requires a stereomicroscope (25x-50x). For some of the larger Hypocreales complete documentation of fresh material is needed.
- Literature resources / identification guides are restricted to specialized literature or non-existent.
- Identification requires a microscope and a good knowledge of the host animals (you need to identify the host).
- Preservation is easy (either in liquid or dried) and corresponds to those used for the animals.
- Web sites exist for e.g. *Cordyceps* and other hypocrealean fungi but other groups are less fortunate.

3.6. Microscopic fungi (molds, aquatic, coprophilous, nematophagous, yeasts, endophytic, ...)

The number of species is very high (many hundreds of thousands worldwide) and because interest in these groups is usually restricted to commercially or industrially important species, their inclusion in an ATBI is exceptional. Some rare artificial assemblages requiring particular substrates, such as coprophilous or nematophagous fungi have attracted the interest of rare amateurs.

- Collecting itself is easy in most cases as one collects in fact only the substrates, but then isolation and identification require laboratory conditions and plating or pure culture techniques for obtaining individual species.
- *In situ* description is not needed.
- Literature resources / identification guides are problematic (specialized literature).
- Identification is very difficult, requires experience in microscopy, and mostly laboratory conditions for culturing and testing specimens, in case of coprophilous fungi humid chamber technique is also a valid alternative.
- Preservation of dried specimens after culture is easy, maintaining living cultures is expensive and difficult.

As these guidelines are only intended for the non-experienced mycologist, the purely microscopical fungal groups are not further discussed here.

4. Preparing for the field

Good preparation begins with reading about the places and types of vegetation you will be visiting. Know what to expect in the field!

- Find out about harmful or dangerous animals or toxic plants (collecting in the USA without knowing what poison ivy looks like (<http://www.poison-ivy.org>), may stop your participation in an ATBI right on the first day).
- Respect customs / traditions in the collecting area.
- Consult host / habitat lists in the area (know what fungi to expect or to look for!). This is especially important when composing the team of participants to your inventory. It is of no use to include many experts on beautiful larger basidiomycete genera such as *Russula*, *Amanita*, *Cortinarius*, various boletes, ... when there are no ectomycorrhizal trees in the area.
- Study as many maps as possible from the area (including phytogeographical and geological maps).
- Detect the possibly best sites for your purpose and know how to get there (driving, walking).
- Hire a local guide and/or local specialist (especially in the tropics).
- Find out about places to stay and what they can offer (e.g. a separate space to work on your collections in the evening).

4.1. What to take with you in the field?

4.1.1. Transporting your specimens

Old newsprint suffices to wrap pieces of wood carrying lichens or resupinate fungi. Well-wrapped, you can stuff all of them together in a plastic or other bag you carry with you in the field, which will keep them sufficiently humid when in the field (don't keep them that way for more than one day since molds will develop very quickly!). It is advisable to take photographs before wrapping up your specimens.

A plant press and newsprint is mostly used for collecting and carrying plant parasitic fungi with you. Compartmented plastic boxes are useful for small species (eventually add moss for humidity). Larger fleshy fungi are best wrapped in aluminum foil or wax paper bags (in the tropics an icebox can be used to keep such collections on ice when traveling by car). When using an open basket to stack collected mushrooms, put the mushrooms upside down so that falling spores do not contaminate other species underneath.

Group	Collecting recipients
Myxomycetes	Boxes of various sizes, eventually with cork or similar materials in the bottom and pins to attach fragile, small or immature samples
Lichens	Paper or paper bags
Plant parasites	Old newspapers / large plastic bags
Animal parasites	Insect containers / liquid / chloroform. Note that bigger quantities of these (flammable) liquids (>90% ethanol) cannot be transported by plane. They will have to be purchased locally or even ordered locally (in some countries denaturated ethanol cannot be bought without a prescription)
Mushrooms and toadstools	Aluminum foil, wax paper bags, plastic containers of various sizes – wide basket or laundry net
Molds / Aquatic / coprophilic / endophytes	Bags for substrate collecting

Table 1. Overview of different collecting recipients.

4.1.2. Barcoding and tissue sampling for later molecular work

Although it is not absolutely imperative to sample tissues of fresh material for barcoding purposes (ribosomal genes can usually be obtained without too much problems from recently dried material), we recommend storing fresh tissue samples in an appropriate buffer as quickly as possible for later molecular research as an added value for your specimens.

If you have sufficient time and/or manpower, start taking tissue samples directly in the field, in this case you will need:

- Sterile Eppendorf tubes filled with 250 or 500 µl of 2x CTAB buffer for taking tissue samples of fleshy fungi *in situ* (the recipe and protocol for preparing CTAB can be found at e.g.: http://www.umich.edu/~mycology/protocols_assets/DNAminipreps.doc).
- Cleaning alcohol, paper tissue, tweezers.
- A permanent marker or pencil (fine tip) to annotate the tubes.
- Labels to go with the specimens.

Another recently developed method that seems excellent for barcoding uses so-called FTA cards (more information available on: <http://www.whatman.com/FTANucleicAcidCollectionStorageandPurification.aspx>)

4.1.3. Photographic equipment

Documenting collections often starts in the field and for many groups of fungi it is the only moment that you will see the specimens in a really fresh or clean condition, so think of taking the necessary photographic equipment with you. Needed are:

- A solid, small tripod.
- A (digital) camera, e.g. with macrolens (50-60 mm) or a wide-angle (18 mm) for larger species; a reflector or a piece of aluminum foil or white paper to provide light from underneath.
- Spare batteries and memory cards.

4.1.4. Geographic referencing

Take your maps, GPS and spare batteries or a compass in areas with insufficient coverage.

If you have little or no sense of orientation, start by taking the GPS coordinates of your car or camp before going out on a collecting trip! It is usually impossible or too time consuming to take coordinates for every collected specimen. Taking coordinates that correspond to homogeneous habitats or niches with a certain radius (10 to 30 m) is therefore often more advisable.

4.2. What else to take?

When collecting, you will need to take notes or write down various information concerning the specimens, their location and habitat. Therefore a **small notebook and pencil** are indispensable (and safer than a dictaphone) for taking notes on host or substrate, references to pictures, geographic coordinates, for writing labels, etc.

A **firm knife** or other digging tool should preferably be used to collect mushrooms from soil (always take care you have the very base of the mushroom!); in other cases a **small folding handsaw** or **pruning knife** (secateur) is needed to collect specimens such as pyrenomycetes or crust-like basidiomycetes growing on twigs or bark of living or dead trees.

Tweezers, nets, pooter, etc. for those collections parasitized by insects, spiders, etc.

Lichens growing on rocks or stones may require a **hammer** and **cold chisel** for collecting (in this case the use of **protective glasses** and **gloves** is recommended as well!). Also for lichens a **small spray-bottle with water** can be useful (damp thalli are more likely to remain intact during collection).

It is also very important to carry a small magnifying glass or hand lens to observe your specimens when collecting in the field. Taking a **hand lens (10x-20x magnification)** is absolutely recommended, especially for smaller species, myxomycetes, pyrenomycetes, etc.

A **walking stick** is useful not only for walking, but is also very handy with regard to uncover snakes or wasp nests, discarding spider webs, turning over litter, etc. especially in tropical and subtropical areas (any stick will do).

Don't forget to bring a suitable **repellent** against leaches, ticks, mosquitoes, chiggers, etc. especially since mycologists don't move a lot!

5. In the field

5.1. Collecting specimens

Always collect good quality material. Look around for a good specimen rather than collecting the first one you see. In some groups, it will be important to gather all different life or maturity stages you encounter, while in others fully mature material will suffice. Collecting young, mature and old specimens can indeed be very important because identification keys may be based on features only visible in very young or very old specimens.

- **Lichenized fungi** and **slime molds** are straightforward to collect. You can see practically the entire organism and it is usually easy to collect at least part of it. Slime molds can be extremely small and without a hand lens (minimum 10x magnification) you will not be able to do very much.
- Collecting **lichenized fungi** is very much as collecting bryophytes (see chapter 13). Place specimens in breathable bags or folded packets made of brown, white, or wax paper or even newsprint. Put only one species from one substrate in each bag or packet (eventually more than one specimen for common species). Collect entire, intact and preferably fertile thalli, part of a specimen is sufficient for uncommon to rare species.
- Collecting **plant or animal pathogens** is very similar to collecting the host plants (with the difference that you collect now only the parts that look attacked or ill) or the host animals. Collect parts with different aspects or stages of the disease if possible. Use newsprint and a plant press for plant pathogens. Screen collected hosts with a hand lens (if appropriate). Host animals are best stored in small vials. The latter need to be labeled clearly.
- For **fleshy fungi**, mycologists usually only collect the above-ground (or below-ground truffles), sexual fruiting bodies or 'mushrooms' of the fungus. The first thing you have to realize when collecting the softer, fleshy mushrooms, is that they are mainly composed of water (up to 90%) and that they will start to rot the moment you collect them. In a tropical climate this happens within hours or less, in more temperate or cool areas it may take days. Therefore, avoid long distances to and from the field and try to keep your specimens as cool as possible. Use different types of containers, boxes or bags to ensure a good storage and transport of specimens of variable shapes and sizes. Do not collect more than what you and your drier can handle after you return from the field! It is a waste to spend time collecting too much material. Be selective in the field and go for representative and well-documented specimens, instead of throwing away in the evening what you collected in the morning.

Beware to collect the whole 'mushroom', particularly if the stipe base is hidden in the substrate.

Include both young and mature specimens in a sample.

Particularly fragile or tiny mushrooms should be transported in closed, rigid containers that maintain maximum humidity (adding moss is a very efficient way to achieve this!).

Very large specimens are difficult to transport, dry and preserve as such. Usually they are sliced into smaller pieces, making sure every section retains a representative part of every structure (cap, stipe, gills or tubes, etc.).

We recommend the use of aluminum foil or wax paper to wrap your specimens whenever possible. It will keep them fresh for a longer time, reduces the risk of contamination and makes it easy to add a label. However, if you decide to stack gilled mushrooms, boletes, etc. in an open basket without packing them individually, put your specimens always with the stipe pointing upward so that no clouds of falling spores can contaminate the specimens that are just underneath. Always protect the mushroom basket from direct sunlight and don't leave it in the car when you stop for a break as your collections will quickly deteriorate in an overheated vehicle.

5.1.1. Which are the best sites for collecting fungi?

Of course the answer to this question depends on what group you are interested in. Moreover, a site can have an excellent reputation for the fungi you are looking for, but if the season is wrong or if the rains fail, it may leave you empty-handed.

BEWARE! Collecting can be a sensitive item. In most countries, collection / picking of larger fungi is usually restricted or forbidden because of excessive and destructive collecting of several commercial species in the past. Because of this commercial value and the fact that they are considered to be some sort of wild 'fruits', larger fungi are considered the property of the landowner in many countries. Therefore, be sure to have the necessary permissions to collect in the places you visit, and avoid offending or provoking other visitors and tourists by collecting in crowded or public places for example. This also applies when cutting lichens from tree bark or other substrates: keep in mind that other people can take offense when someone cuts into a tree.

Ascomycetes with apothecia – so-called discomycetes or 'cup-fungi' – should be collected following the same principles as other macrofungi, and careful notes on colour, size, presence of hairs and other external features should be taken. The nature of the substrate, and if at all possible the host (if present) should be described or identified. Species vary from very tiny (less than 100 µm in diameter) to huge complex structures as those of morels (*Morchella* spp.). Many fruit directly on soil, and can be ectomycorrhizal as many basidiomycetes, others produce ascomata on living or dead bryophytes, on fallen leaves from trees, on dead herbaceous stems, on dead wood on dry land or in stagnant or running water and in a range of other habitats. Some are adapted to withstand

desiccation and can be collected high up in trees (just as a range of corticioid basidiomycetes). Such tiny species are usually collected together with the substrate they are growing on. Ascomycetes with perithecia constitute another very large and diverse group. Some have single perithecia seated directly on or immersed in the substrate, be it rotten wood, still corticated twigs, herbaceous stems, dung, etc. while other species have so-called stromatic structures that may house up to several thousands of individual perithecia. Such stromata can be very large (up to more than 20 cm), and develop either well above the substrate on some kind of 'stipe' or they can be hidden under bark or develop as a layer on top of the substrate.

For myxomycetes, good places you may want to explore include highly decomposed or rotten wood, litter layers, undergrowth of dense bushes, heaps of decomposing *Urtica*, *Salvia* spp., various umbelliferous plants, ... and especially after heavy rains also vertical surfaces such as moss-covered rocks or walls and tree trunks.

5.1.2. Collecting substrates for later observation in humid chamber

For some groups, in particular slime molds and coprophilous fungi, the technique of the humid chamber is frequently used. It consists in the collection of substrate (soil, decomposing litter, pieces of rotten or fresh bark or wood for myxomycetes, animal excrements for coprophilous fungi, soil or other substrates for microscopic fungi) that are simply dried to be rehumidified later and examined regularly under the dissecting microscope for freshly fruiting structures within the humid atmosphere of a Petri dish or other plastic containers or in culture media.

5.2. Photographing specimens in the field

For some groups of mushrooms, in particular very fragile species (e.g. *Leucocoprinus*, *Coprinus*, *Psathyrella*) or species with evanescent parts or structures (presence of powdery or arachnoid veils, glutinous surfaces, local exudation of droplets), *in situ* pictures are the only guarantee for a good picture of the fresh specimens.

Although you may want to show the mushrooms exactly as you found them and thus leave them untouched for the picture, there are very few situations in which this will result in an informative, scientific picture. It will usually be necessary to 'cheat' and move some of the specimens closer to one another to have them all in focus (sharp), and to turn others so that details of the gills and stipe become clearly visible in the photograph. A cross section of one fruit-body may often be useful to highlight diagnostic features of context and stipe.

A mycologist should be particularly attentive to the following aspects:

- Use a small but stable tripod in the field. It will allow for longer exposure times and thus result in considerably more depth of field and less blurry pictures.
- Avoid direct sunlight on your subject as it results in too much contrast.

- Avoid using a flash in the field to obtain correct colours and better contrast.
- Use a reflector instead to brighten up the dark parts of the fungus (underneath the cap mostly).
- Photograph from close-by and frame the fungus to fill the image as much as possible. Tiny mushrooms in a large landscape convey little information. Using a macro lens is therefore a good solution.
- To appreciate the importance of these aspects, you can check out the photographs explaining 'how to do it' and 'what to avoid' on http://www.mtsn.tn.it/russulales-news/tc_photographs.asp

6. Back from the field

Depending on the collected species, you will have to work on the collected specimens before processing them for later identification and preservation.

Some recommendations for working on fungal collections:

- Start by assigning a unique number to each of your specimens. These numbers can be continuous throughout your herbarium. Label all related documents (pictures, tissue samples, spore deposits, descriptive notes, etc.) from this specimen with the same number.
- Decide on priorities in function of fragility and ephemeral character of specimens and set up for spore deposits.
- Team-work! It is more efficient to have a single person taking all the pictures, another person doing all tissue sampling, ...
- Mycology does require a certain comfort!
- Good (white or natural) light is required for good description and appreciation of colours. Therefore, taking a good lamp with you for evening work is absolutely recommended (best fitted with a day light bulb).
- A lot of space is needed to sort collections and taking pictures, spore deposits and tissue samples... Be sure you have enough space available!
- Work protected from rain and wind (Fig. 1).



Fig. 1. Remember that a fungal inventory is for the greater part taking notes, spore prints, sampling tissues; therefore, an adequate, sufficiently large, dry and wind-free space for doing these various activities is hardly a luxury. Camping offers not really the ideal solution for a fungal inventory. (Photo by T. Laessoe).

6.1. Barcoding (using CTAB method)

If you want to add scientific value to your specimens by optimizing future sequencing possibilities, take small parts (see Table 2) of the specimens and put them in an Eppendorf tube with 0.5 ml or 0.25 ml CTAB buffer (or preferably CTAB 2x for fleshy mushrooms as they contain up to 90% of water).

Group	Tissue to be collected
Myxomycetes	Entire sporocysts
Lichens	Reproductive structures
Plant parasites	Various types of spores
Animal parasites	Small parts of spore producing surfaces
Mushrooms and toadstools	Small parts of spore producing surfaces or context
Molds / Aquatic/ coprophilic / endophytes	n.a.

Table 2. Tissue to be collected per group.

6.1.1. Sampling protocol example for larger fungi

- Sample the tissues **as soon as possible** after collecting the fungus (you can even do it in the field if there is time for it).
- Use **clean tweezers** (with tips not necessarily sterilized, but at least well cleaned with soft paper tissue (eventually drenched in alcohol 70% or higher)).
- Choose parts of the gills that look **perfectly clean**, that are not parasitized by molds and not attacked by animals or other microorganisms (insect larvae, collembolla, mites, etc.). If gills seem not very clean, you can also cut the mushroom lengthwise and take tissue sample from the firm parts of the flesh inside cap or stipe.
- Take about the quantity of gill or flesh **tissue that corresponds to half of the amount of CTAB** liquid in the tube, not more.
- Close the Eppendorf tubes **very tightly** when finished.
- Write the **collection number on the side** of the tube, and **also on top** of the lid, using a fine permanent marker.
- Repeat for **a second tube** or eventually up to 3-4 tubes for very rare species.

6.2. Documenting collections

6.2.1. Morphology

As you can see from Table 3, most groups of fungi do not need to be described in detail immediately after collecting.

Group	Need for immediate documentation	Preservation method
Myxomycetes	No	Air dried immediately
Lichens	No	Air dried immediately
Plant parasites	No	Air dried as for botanical specimens
Animal parasites	No	Micr. prep. / liquid (alcohol, formol)
Mushrooms and toadstools	Yes	Dried after description
Molds / Aquatic / coprophilic / endophytes	No	Needs lab work for isolation, later dried after culturing/ kept as micr. prep. / or living culture

Table 3. Preservation methods.

In particular the larger fleshy mushrooms require elaborate description before being dried because the conservation method (implying rapid drying using a desiccator) will completely change their general aspect!

- Do not collect too much specimens at a time since description afterwards is very time-consuming.
- Process specimens as soon as possible because they lose their features rapidly after collecting.

In view of later identification, it is essential to record those features that will disappear once the specimen is dried, in particular:

- Dimensions of all parts (cap diameter, stipe length and width, gill spacing, gill height, etc.).
- Colour and colour changes (we recommend to use a colour code for precise notation, but these printed colour books are becoming increasingly difficult to find).
- Taste (it is safe to taste a very small part of the mushroom, including toxic species, on the condition to spit out all the parts! The mastication should take at least 60 sec).
- Check the smell.

The use of description forms is recommended as it avoids omitting features. It also offers a standard and usually much faster way of documenting your specimens when a pre-established list of possibilities (using correct terminology) is given for every character.

The easiest way to document your collections is by taking additional digital pictures of all informative details (*i.e.* sections of fruitbodies, colour changes, young and older specimens, interesting details of veils, droplets, excretions, etc.) using good lighting, long exposure, circular flash (if you must). In this way, a full image record of your specimens is made by taking macro-photographs of all possible aspects of the fruitbodies (habitus, surfaces, sections, scales, pores, insertion of tubes or lamellae, chemical reactions, etc.). This is best done by placing the specimens or sections together with a reference for (i) dimensions, (ii) the collection number and (iii) colour using *e.g.* a Pantone colour strip (see De Kesel, 2004).

Ascomycetes should be collected along the same principles as other macrofungi, and careful notes on colour, size, presence of hairs and other external features should be taken. If at all possible, groups such as Pyrenomycetes should be cultivated from spores or tissue when collected (or later after gentle air drying) and whilst more carbonized groups (because of stroma tissue) require less work on the fresh material, you should always try to provide details on a section through the stroma to annotate the colour and texture of the interior of the stromatic tissue. In an ideal world, the microscopical features should be studied in water mounts whilst spores are still living (so-called vital taxonomy, see Baral, 1992), but this is hardly possible when collecting under primitive field conditions.

6.2.2. Chemical reactions on various parts of the larger fungi

Chemical reagents are often applied on fresh material of larger fungi for identification purposes. Since a number of chemical tests are only used in selected genera, the choice of chemicals used and the part(s) of the fruitbody where they will be applied on, will depend from the fungal group at hand. A complete list and illustrated examples of their application can be found at <http://www.champignons-passion.be/main.htm>

The following reagents are often used on fresh material to help identify various groups of larger fungi:

- Ammonium (pure)
- Anilin (Schaeffer's reaction)
- Nitric acid (Schaeffer's reaction)
- Ammonium hypochlorite solution ('Eau de Javel')
- Formol 38% (pure, laboratory quality, not commercial)
- Phenol (3% solution in distilled water)
- Potassium (10-20% solution in distilled water)
- Gaïac (10% solution in 80° alcohol)
- Ammonium (10% solution in distilled water)
- Iron sulfate (crystal)
- Dr. Henry's TL4
- Sulfuric acid twice diluted (50%)
- Vanillin (pure)

6.2.3. Preparing spore deposits

Another important aspect for later identification, and again mainly restricted to the larger fungi, is the precise colour of the spore deposit. A spore deposit (or 'spore print') should thus be obtained whenever possible. An illustrated explanation on how to do this can be found at http://www.mushroomexpert.com/spore_print.html or in De Kesel (2004).

We recommend the use of transparencies (transparent plastic film) for making spore deposits. Cut to smaller pieces they constitute a very light support for the spore print and allow a more accurate determination of the colour (you can superimpose it on existing colour codes) and easier preparation of microscopic slides for spore observation (by cutting a part of the plastic film for direct observation with the appropriate reagent).

- Use plastic film for exact colour notation (better than on white paper).
- Use closed recipients (no air currents).

- Allow for sufficient but not excessive humidity (adding some moss in the container is perfect)..
- Wait for 6-12 hours and note the colour of the fresh spore print immediately. For fragile, tiny specimens this often implies sacrificing an entire specimen.
- For resupinate fungi on wood, it is recommended to rehydrate the specimens prior to making a spore print, and to keep the fragments used for spore printing slightly away from the plastic film by placing them on light matches.

6.3. Conditioning specimens for conservation

6.3.1. Drying specimens (herbarium)

Myxomycetes, Lichens, plant pathogens are mostly air dried.

- Use small cardboard or plastic boxes to keep myxomycetes, and permanent packets folded from acid-free paper with 25% or higher rag content for lichens, or herbarium sheets from acid-free paper for plant pathogens.
- After drying, we recommend you to freeze lichens for five days at -20°C (-5°F). This will kill most arthropods without damaging the lichens.



Fig. 2. Ziplocks (plastic bags that can be hermetically closed) are probably the best solution to keep and store your fungi once well dried. Just remember to keep them out of the sun to avoid eventual condensation. (Photo by B.Buyck).

Larger fungi should be quickly dried using a dessicator at 40-50°C. There exist several commercial models that work on electricity. In more modest working conditions a field dryer (De Kesel, 2001) or a cardboard box purchased locally, both using kerosene lamps or with a simple light bulb at the base, can help you out as well.

- Cut or slice large or very hard specimens.
- Use ziplock plastic bags (they come in various sizes) for storing your dried specimens in order to avoid rehydration when working in humid conditions (Fig. 2).

6.3.2. Store in liquid (alcohol, Wasson liquid)

- Very tiny or fragile specimens.
- Jelly fungi (although these can also be dried).
- Insects and other arthropods.

6.3.3. Permanent microscopic preparations for microscopic fungi

- From cultures mostly / parasites / symbionts (not further detailed here).

7. Some important identification or other web-resources for a fungal ATBI

Directory of mycological resources on the net:

- <http://mycology.cornell.edu/>

Fungal pages or photographs on the net:

- <http://www.grzyby.pl/fglobal-directory.htm>

Digital archive for books, journals, thesauri, indexes and other publication important to systematic mycology:

- <http://194.203.77.76/LibriFungorum/Resources.asp>
- <http://www.cybertruffle.org.uk/cyberliber/>

Various information on mycologists and fungal taxa:

- <http://www.cybertruffle.org.uk/eng/index.htm>

Index to published fungal names

- <http://www.speciesfungorum.org/Names/Names.asp>
- <http://www.cybertruffle.org.uk/cybernome/eng/index.htm>
- <http://www.mycobank.org/MycoTaxo.aspx>

Search for articles by either author or fungal genus

- <http://www.speciesfungorum.org/BSM/bsm.asp>

Synoptic multi-access key for identification of fungi and many links to other resources

- www.mycokokey.com

Lichen related topics

- <http://www.lichens.ie/links>

Mycological societies in the world

- <http://www.euromould.org>

8. References

BARAL, H.-O. 1992. Vital versus herbarium taxonomy: morphological differences between living and dead cells of Ascomycetes, and their taxonomic implications. *Mycotaxon* 44: 333-390.

BUYCK, B. 1999. Taxonomists are an endangered species in Europe. *Nature* 401: 321.

DE KESEL, A. 2001. A mushroom dryer for the travelling mycologist. *Field Mycology* 2: 131-133.

DE KESEL, A. 2004. Réalisation d'un herbier mycologique. In: FISH L. La préparation des échantillons d'herbier (traduction française et adaptation par DEGREEF J., DE KESEL A. & AUGIRON K.). Jardin Botanique National de Belgique, Meise. *Scripta Botanica Belgica* 31: 71-83.

HAWKSWORTH, D.L. 2001. The magnitude of fungal diversity: the 1.5 million species estimate revisited. *Mycological Research* 105: 1422-1432.

HIBBETT, D.S.; BINDER, M., BISCHOFF, J.F.; BLACKWELL, M., CANNON, P.F., ERIKSSON, O.E.; HUHDORF, S., JAMES, T.; KIRK, P.M., LÜCKING R., LUMBSCH, H.T., LUTZONI, F.; MATHENY, P.B., MCLAUGHLIN, D.J.; POWELL, M.J., REDHEAD, S., SCHOCH, C.L., SPATAFORA, J.W., STALPERS, J.A., VILGALYS, R., AIME, M.C., APTROOT, A.; BAUER, R., BEGEROW, D.; BENNY, G.L., CASTLEBURY, L.A., CROUS, P.W., DAI, Y.C.; GAMS, W., GEISER, D.M., GRIFFITH, G.W., GUEIDAN, C., HAWKSWORTH, D.L., HESTMARK, G., HOSAKA, K., HUMBER, R.A., HYDE, K.D., IRONSIDE, J.E., KÖLJALG, U., JYRTZNABM C.P., LARSSON, K.H., LICHTWARDT, R., LONGCORE, J., MIADLIKOWSKA, J., MILLER, A., MONCALVO, J.M.; MOZLEY-STANDRIDGE, S., OBERWINKLER, F., PARMASTO, E., REEB, V., ROGERS, J.D., ROUX, C., RYVARDEN, L., SAMPAIO, J.P., SCHÜBLER, A., SUGIYAMA, J., THORN, R.G., TIBELL, L., UNTEREINER, W.A., WALKER, C., WANG, Z., WEIR, A., WEIS, M., WHITE, M.M.; WINKA, K., YAO, Y.J. & ZHANG, N. 2007. A higher-level phylogenetic classification of the Fungi. *Mycological Research* 111: 509-547.

STRAATSMA, G., AYER, F. & EGLI, S. 2001. Species richness, abundance, and phenology of fungal fruit bodies over 21 years in a Swiss forest plot. *Mycological Research* 105: 515-523.

8.1. General references for slime molds

- BOZONNET, J., MEYER, M. & POULAIN, M. 1992. Spécial Myxomycètes. *Bulletin de la Fédération. Mycologique Dauphiné-Savoie* 125: 4-37 (in French).
- NEUBERT, H., NOWOTNY, W. & BAUMANN, K. 1993. *Die Myxomyceten Deutschlands und des angrenzenden Alpenraumes unter besonderer Berücksichtigung Österreichs, Band 1: Ceratiomyxales, Echinosteliales, Liceales, Trichiales*. Verlag Baumann, Gomaringen: 344 pp.
- NEUBERT, H., NOWOTNY, W. & BAUMANN, K. 1995. *Die Myxomyceten Deutschlands und des angrenzenden Alpenraumes unter besonderer Berücksichtigung Österreichs, Band 2: Physarales*. Verlag Baumann, Gomaringen: 368 pp.
- NEUBERT, H., NOWOTNY, W. & BAUMANN, K. 2000. *Die Myxomyceten Deutschlands und des angrenzenden Alpenraumes unter besonderer Berücksichtigung Österreichs, Band 3: Stemonitales*. Verlag Baumann, Gomaringen: 391 pp.
- ING, B. 1999. *The Myxomycetes of Britain and Ireland. An Identification Handbook*. Richmond Publishing Co, Slough: 374 pp.
- MARTIN, G. W. & ALEXOPOULOS, C.J. 1969. *The Myxomycetes*. Univ. Iowa press, Iowa City: 561 pp.
- NANNENGA-BREMEKAMP, N.E. 1974. *De Nederlandse Myxomyceten, met aanvullingen I (1979) & II (1983)*. Zutphen: 506 pp (in Dutch, English translation 1991).
- POULAIN, M., MEYER M. & BOZONNET J. (in prep. for 2010). Les myxomycètes. 540 species of slime molds illustrated in colour. (in French, English translation by Annie Kohn).
- STEPHENSON, S.L. & STEMPEN H. 1994. *Myxomycetes - A handbook of Slime molds*. Portland Timber Press Inc., Portland: 200 pp.
- YAMAMOTO, Y. 1998. *The Myxomycete Biota of Japan*. Toyo Shorin Publishing, Tokyo: 700 pp (in Japanese).

8.2. Existing references for fungal ATBI's

- LICKEY, E.B., SHANNON, M.T., HUGHES, K.W. & PETERSEN, R.H. 2007. The Mushroom TWiG. A Marvelous Mycological Menagerie in the Mountains. *Southeastern Naturalist*, Special issue 1: 73-82.
- ROSSMAN, A.Y., TULLOSS, R.E., O'DELL, T.H., & THORN, R.G. 1998. *Protocols for an All Taxa Biodiversity Inventory of Fungi in a Costa Rican conservation area*. Parkway Publishers inc., Boone, North Carolina: 195 pp.

8.3. General references for description and terminology of fungi

BERGER, K. 1980. *Mykologisches Wörterbuch*. Gustav Fisher Verlag, Jena: 432 pp.

JOSSERAND, M. 1983. *La description des champignons supérieurs*. Lechevalier, Paris: 392 pp.

MOREAU, P.-A., BIRABEAU, J.-P., CATTIN, P., DEBEAUVAIS, H., DELAVENNAT, G., DÉIANA, J.-C., FAVRE, A., FILLION, R., FRANCINI, L., MEYER, M., MUGNIER, M., PELLICIER, P., PISOT, J., SAVIUC, P. & CHANCRIN, C. 2002. *A la découverte des champignons. Une introduction à la mycologie*. Fédération Mycologique Dauphiné-Savoie, Bassens : 62 pp.

KIRK, P.M., CANNON, P.F., MINTER, D.W. & STALPERS, J.A. 2008. *Dictionary of the fungi*. 10th edition. CABI Wallingford, UK: 640 pp.

Manual on field recording techniques and protocols for All Taxa Biodiversity Inventories and Monitoring

Abc Taxa

If the Biosphere were a kitchen, this would be the cookbook every kitchen hand working in it would want to have. It is encyclopaedic in scope, without missing on detail where it's necessary.

The aim is to provide a guide to undertaking All Taxa Biodiversity Inventory+Monitoring (ATBI+M), with the laudable aim of accelerating the integration of taxonomic knowledge with biodiversity conservation and management. The ATBI+M approach has its critics, but there can be little doubt that the more information we can garner at the species level of biodiversity, the better we will be able to manage it as a whole. Warning against the complacency of one-time surveys there is advice on groups from whales to waterbears; slime moulds to forest trees, and everything in between. Particularly pleasing is the inclusion of a broad range of habitats, especially marine and freshwater. Some chapters are also on unexpected but important survey methods including bio-acoustics, camera trapping, and on specimen handling and preservation. Each chapter also has plenty of "how to's" for preservation and heaps of leads for identification – even in one case the advice on what sort of accommodation actually works in the field! And, as pioneered in Central America, reference to how para- and amateur taxonomists (increasingly called citizen science) must be part of the process if the exercise is to work.

Even if you are not doing an ATBI+M you will find this book useful, even fascinating. There is much much more in it than "just" collecting and survey advice. It may not seem bedtime reading, but just try it is my advice. Happy inventorying!.

April 2010

Dr. Peter Bridgewater
Chair of the UK Joint Nature Conservation Committee
United Kingdom